



MC74AC194 MC74ACT194

4-Bit Bidirectional Universal Shift Register

The MC74AC194/74ACT194 is a high-speed 4-bit bidirectional universal shift register. As a high-speed multifunctional, sequential building block, it is useful in a wide variety of applications. It may be used in serial-serial, shift left, shift right, serial-parallel, parallel-serial, and parallel-parallel data register transfers. The 'AC/ACT194 is similar in operation to the 'AS195 universal shift register, with added features of shift left without external connections and hold (do nothing) modes of operation.

- Typical Shift Frequency of 150 MHz
- Asynchronous Master Reset
- Hold (Do Nothing) Mode
- Fully Synchronous Serial or Parallel Data Transfers

FUNCTIONAL DESCRIPTION

The MC74AC/74ACT194 contains four edge-triggered D flip-flops and the necessary interstage logic to synchronously perform shift right, shift left, parallel load and hold operations. Signals applied to the Select (S_0 , S_1) inputs determine the type of operation, as shown in the Mode Select Table. Signals on the Select, Parallel data (P_0 – P_3) and Serial data (D_{SR} , D_{SL}) inputs can change when the clock is in either state, provided only that the recommended setup and hold times, with respect to the clock rising edge, are observed. A LOW signal on Master Reset (MR) overrides all other inputs and forces the outputs LOW.

4-BIT BIDIRECTIONAL
UNIVERSAL SHIFT
REGISTER

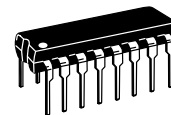

N SUFFIX
CASE 648-08
PLASTIC

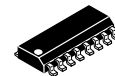

D SUFFIX
CASE 751B-05
PLASTIC

MODE SELECT TABLE

Operating Mode	Inputs						Outputs			
	MR	S_1	S_0	D_{SR}	D_{SL}	P_n	Q_0	Q_1	Q_2	Q_3
Reset	L	X	X	X	X	X	L	L	L	L
Hold	H	l	l	X	X	X	q_0	q_1	q_2	q_3
Shift Left	H	h	l	X	l	X	q_1	q_2	q_3	L
	H	h	l	X	h	X	q_1	q_2	q_3	H
Shift Right	H	l	h	l	X	X	L	q_0	q_1	q_2
	H	l	h	h	X	X	H	q_0	q_1	q_2
Parallel Load	H	h	h	X	X	p_n	P_0	P_1	P_2	P_3

l = LOW voltage level one setup time prior to the LOW-to-HIGH clock transition.
h = HIGH voltage level one setup time prior to the LOW-to-HIGH clock transition.
 P_n (q_n) = Lower case letters indicate the state of the referenced input (or output) one setup time prior to the LOW-to-HIGH clock transition.
H = HIGH Voltage Level
L = LOW Voltage Level
X = Immaterial

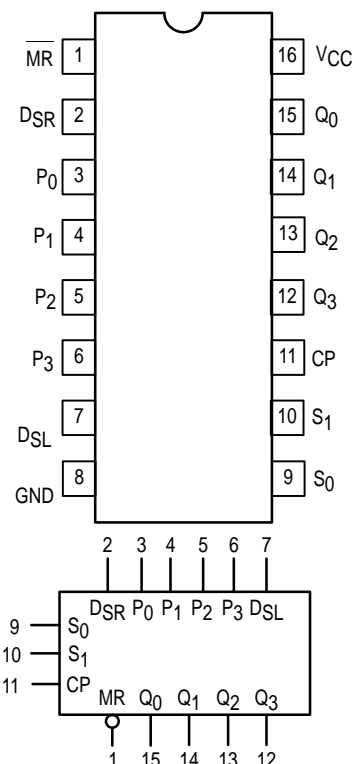

MC74AC194 MC74ACT194

LOGIC DIAGRAM

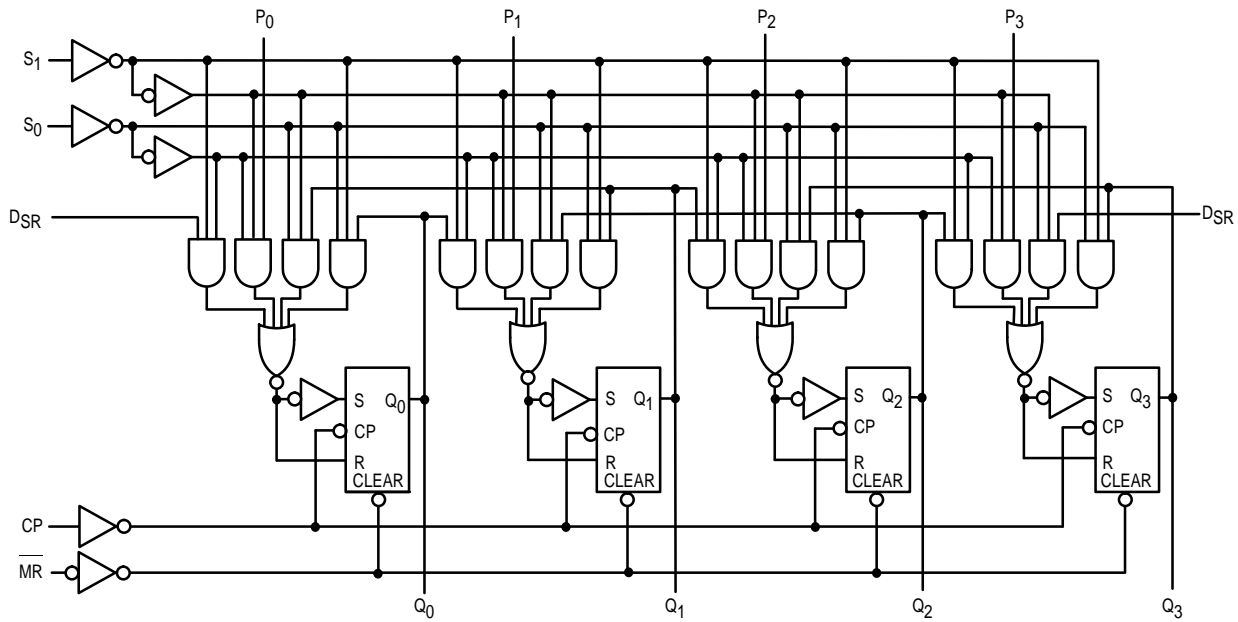

Please note that this diagram is provided only for the understanding of logic operations and should not be used to estimate propagation delays.

MAXIMUM RATINGS*

Symbol	Parameter	Value	Unit
V _{CC}	DC Supply Voltage (Referenced to GND)	-0.5 to +7.0	V
V _{in}	DC Input Voltage (Referenced to GND)	-0.5 to V _{CC} +0.5	V
V _{out}	DC Output Voltage (Referenced to GND)	-0.5 to V _{CC} +0.5	V
I _{in}	DC Input Current, per Pin	±20	mA
I _{out}	DC Output Sink/Source Current, per Pin	±50	mA
I _{CC}	DC V _{CC} or GND Current per Output Pin	±50	mA
T _{stg}	Storage Temperature	-65 to +150	°C

* Maximum Ratings are those values beyond which damage to the device may occur. Functional operation should be restricted to the Recommended Operating Conditions.

MC74AC194 MC74ACT194

RECOMMENDED OPERATING CONDITIONS

Symbol	Parameter	Min	Typ	Max	Unit	
V _{CC}	Supply Voltage	'AC	2.0	5.0	6.0	V
		'ACT	4.5	5.0	5.5	
V _{in} , V _{out}	DC Input Voltage, Output Voltage (Ref. to GND)	0		V _{CC}	V	
t _r , t _f	Input Rise and Fall Time (Note 1) 'AC Devices except Schmitt Inputs	V _{CC} @ 3.0 V		150		ns/V
		V _{CC} @ 4.5 V		40		
		V _{CC} @ 5.5 V		25		
t _r , t _f	Input Rise and Fall Time (Note 2) 'ACT Devices except Schmitt Inputs	V _{CC} @ 4.5 V		10		ns/V
		V _{CC} @ 5.5 V		8.0		
T _J	Junction Temperature (PDIP)			140	°C	
T _A	Operating Ambient Temperature Range	-40	25	85	°C	
I _{OH}	Output Current — High			-24	mA	
I _{OL}	Output Current — Low			24	mA	

1. V_{in} from 30% to 70% V_{CC}; see individual Data Sheets for devices that differ from the typical input rise and fall times.
 2. V_{in} from 0.8 V to 2.0 V; see individual Data Sheets for devices that differ from the typical input rise and fall times.

DC CHARACTERISTICS

Symbol	Parameter	V _{CC} (V)	74AC		74AC		Unit	Conditions
			T _A = +25°C		T _A = -40°C to +85°C			
			Typ	Guaranteed Limits				
V _{IH}	Minimum High Level Input Voltage	3.0	1.5	2.1	2.1	V	V _{OUT} = 0.1 V or V _{CC} - 0.1 V	
		4.5	2.25	3.15	3.15			
		5.5	2.75	3.85	3.85			
V _{IL}	Maximum Low Level Input Voltage	3.0	1.5	0.9	0.9	V	V _{OUT} = 0.1 V or V _{CC} - 0.1 V	
		4.5	2.25	1.35	1.35			
		5.5	2.75	1.65	1.65			
V _{OH}	Minimum High Level Output Voltage	3.0	2.99	2.9	2.9	V	I _{OUT} = -50 μA	
		4.5	4.49	4.4	4.4			
		5.5	5.49	5.4	5.4			
		3.0		2.56	2.46	V	*V _{IN} = V _{IL} or V _{IH} -12 mA I _{OH} -24 mA -24 mA	
		4.5		3.86	3.76			
5.5		4.86	4.76					
V _{OL}	Maximum Low Level Output Voltage	3.0	0.002	0.1	0.1	V	I _{OUT} = 50 μA	
		4.5	0.001	0.1	0.1			
		5.5	0.001	0.1	0.1			
		3.0		0.36	0.44	V	*V _{IN} = V _{IL} or V _{IH} 12 mA I _{OL} 24 mA 24 mA	
		4.5		0.36	0.44			
5.5		0.36	0.44					
I _{IN}	Maximum Input Leakage Current	5.5		±0.1	±1.0	μA	V _I = V _{CC} , GND	
I _{OLD}	†Minimum Dynamic Output Current	5.5			75	mA	V _{OLD} = 1.65 V Max	
I _{OHD}		5.5			-75	mA	V _{OHD} = 3.85 V Min	
I _{CC}	Maximum Quiescent Supply Current	5.5		8.0	80	μA	V _{IN} = V _{CC} or GND	

* All outputs loaded; thresholds on input associated with output under test.

† Maximum test duration 2.0 ms, one output loaded at a time.

Note: I_{IN} and I_{CC} @ 3.0 V are guaranteed to be less than or equal to the respective limit @ 5.5 V V_{CC}.

MC74AC194 MC74ACT194

AC CHARACTERISTICS (For Figures and Waveforms — See Section 3)

Symbol	Parameter	V _{CC} * (V)	74AC		74AC		Unit	Fig. No.
			T _A = +25°C C _L = 50 pF		T _A = -40°C to +85°C C _L = 50 pF			
			Min	Max	Min	Max		
f _{max}	Maximum Input Frequency	3.3 5.0	130 210		115 150		MHz	3-3
t _{PLH}	Propagation Delay CP to Q	3.3 5.0	2.0 2.0	14.5 12.5	1.5 1.5	16.0 14.0	ns	3-6
t _{PHL}	Propagation Delay CP to Q	3.3 5.0	2.0 2.0	14.5 12.5	1.5 1.5	16.0 14.0	ns	3-6
t _{PHL}	Propagation Delay Reset to Q	3.3 5.0	2.0 2.0	11.0 9.0	1.5 1.5	12.0 10.0	ns	3-6

* Voltage Range 3.3 V is 3.3 V ±0.3 V.
Voltage Range 5.0 V is 5.0 V ±0.5 V.

AC OPERATING REQUIREMENTS

Symbol	Parameter	V _{CC} * (V)	74AC		74AC		Unit	Fig. No.
			T _A = +25°C C _L = 50 pF		T _A = -40°C to +85°C C _L = 50 pF			
			Guaranteed Minimum					
t _s	Setup Time, P _n to Clock	3.3 5.0	4.0 2.5		5.0 3.5		ns	3-9
t _h	Hold Time, P _n to Clock	3.3 5.0	3.5 2.0		4.0 2.5		ns	3-9
t _s	Setup Time, S _n to CP	3.3 5.0	5.5 4.0		6.5 5.0		ns	3-9
t _h	Hold Time, S _n to CP	3.3 5.0	3.5 2.0		4.0 2.5		ns	3-9
t _s	Setup Time, DSR or DSL to Clock	3.3 5.0	5.5 4.0		6.0 4.5		ns	3-9
t _h	Hold Time, DSR or DSL to Clock	3.3 5.0	1.5 2.0		2.0 2.5		ns	3-9
t _w	CP Pulse Width	3.3 5.0	5.5 4.0		6.0 4.5		ns	3-6
t _w	MR Pulse Width	3.3 5.0	5.5 4.0		6.0 4.5		ns	3-9
t _{rec}	Recovery Time MR to CP	3.3 5.0	1.5 1.0		1.5 1.0		ns	3-9

* Voltage Range 3.3 V is 3.3 V ±0.3 V.
Voltage Range 5.0 V is 5.0 V ±0.5 V.

MC74AC194 MC74ACT194

DC CHARACTERISTICS

Symbol	Parameter	V _{CC} (V)	74ACT		74ACT		Unit	Conditions
			T _A = +25°C		T _A = -40°C to +85°C			
			Typ	Guaranteed Limits	Typ	Guaranteed Limits		
V _{IH}	Minimum High Level Input Voltage	4.5	1.5	2.0	2.0	V	V _{OUT} = 0.1 V or V _{CC} - 0.1 V	
		5.5	1.5	2.0	2.0			
V _{IL}	Maximum Low Level Input Voltage	4.5	1.5	0.8	0.8	V	V _{OUT} = 0.1 V or V _{CC} - 0.1 V	
		5.5	1.5	0.8	0.8			
V _{OH}	Minimum High Level Output Voltage	4.5	4.49	4.4	4.4	V	I _{OUT} = -50 μA	
		5.5	5.49	5.4	5.4			
		4.5		3.86	3.76	V	*V _{IN} = V _{IL} or V _{IH} -24 mA	
		5.5		4.86	4.76		I _{OH} -24 mA	
V _{OL}	Maximum Low Level Output Voltage	4.5	0.001	0.1	0.1	V	I _{OUT} = 50 μA	
		5.5	0.001	0.1	0.1			
		4.5		0.36	0.44	V	*V _{IN} = V _{IL} or V _{IH} 24 mA	
		5.5		0.36	0.44		I _{OL} 24 mA	
I _{IN}	Maximum Input Leakage Current	5.5		±0.1	±1.0	μA	V _I = V _{CC} , GND	
ΔI _{CCT}	Additional Max. I _{CC} /Input	5.5	0.6		1.5	mA	V _I = V _{CC} - 2.1 V	
I _{OLD}	†Minimum Dynamic Output Current	5.5			75	mA	V _{OLD} = 1.65 V Max	
I _{OHD}		5.5			-75	mA	V _{OHD} = 3.85 V Min	
I _{CC}	Maximum Quiescent Supply Current	5.5		8.0	80	μA	V _{IN} = V _{CC} or GND	

* All outputs loaded; thresholds on input associated with output under test.

† Maximum test duration 2.0 ms, one output loaded at a time.

AC CHARACTERISTICS (For Figures and Waveforms — See Section 3)

Symbol	Parameter	V _{CC} * (V)	74ACT			74ACT		Unit	Fig. No.
			T _A = +25°C C _L = 50 pF			T _A = -40°C to +85°C C _L = 50 pF			
			Min	Typ	Max	Min	Max		
f _{max}	Maximum Input Frequency	5.0	210			150		MHz	3-3
t _{PLH}	Propagation Delay CP to Q	5.0	2.0		13.0	1.5	13.5	ns	3-6
t _{PHL}	Propagation Delay CP to Q	5.0	2.0		12.5	1.5	14.0	ns	3-6
t _{PHL}	Propagation Delay MR to Q	5.0	2.0		12.5	1.5	14.0	ns	3-6

* Voltage Range 5.0 V is 5.0 V ±0.5 V.

MC74AC194 MC74ACT194

AC OPERATING REQUIREMENTS

Symbol	Parameter	V _{CC} * (V)	74ACT	74ACT	Unit	Fig. No.
			T _A = +25°C C _L = 50 pF	T _A = -40°C to +85°C C _L = 50 pF		
			Guaranteed Minimum			
t _s	Setup Time, P _n to CP	5.0	2.5	3.5	ns	3-9
t _h	Hold Time, P _n to CP	5.0	1.5	2.0	ns	3-9
t _s	Setup Time, S _n to CP	5.0	3.5	4.5	ns	3-9
t _h	Hold Time, S _n to CP	5.0	1.5	2.0	ns	3-9
t _s	Setup Time, DSR or DSL to Clock	5.0	5.0	5.5	ns	3-9
t _h	Hold Time, DSR or DSL to Clock	5.0	1.5	2.0	ns	3-9
t _w	CP Pulse Width	5.0	4.0	4.5	ns	3-9
t _w	MR Pulse Width, LOW	5.0	4.0	4.5	ns	3-9
t _{rec}	Recovery Time MR to CP	5.0	1.0	1.5	ns	3-9

* Voltage Range 5.0 V is 5.0 V ±0.5 V.

CAPACITANCE

Symbol	Parameter	Value Typ	Unit	Test Conditions
C _{IN}	Input Capacitance	4.5	pF	V _{CC} = 5.0 V
CPD	Power Dissipation Capacitance	125.0	pF	V _{CC} = 5.0 V

MC74AC194 MC74ACT194

OUTLINE DIMENSIONS

N SUFFIX PLASTIC DIP PACKAGE CASE 648-08 ISSUE R

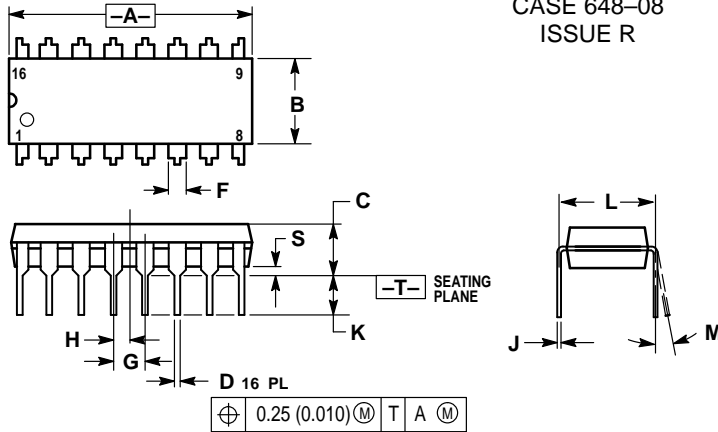

NOTES:

- DIMENSIONING AND TOLERANCING PER ANSI Y14.5M, 1982.
- CONTROLLING DIMENSION: INCH.
- DIMENSION L TO CENTER OF LEADS WHEN FORMED PARALLEL.
- DIMENSION B DOES NOT INCLUDE MOLD FLASH.
- ROUNDED CORNERS OPTIONAL.

DIM	INCHES		MILLIMETERS	
	MIN	MAX	MIN	MAX
A	0.740	0.770	18.80	19.55
B	0.250	0.270	6.35	6.85
C	0.145	0.175	3.69	4.44
D	0.015	0.021	0.39	0.53
F	0.040	0.70	1.02	1.77
G	0.100 BSC		2.54 BSC	
H	0.050 BSC		1.27 BSC	
J	0.008	0.015	0.21	0.38
K	0.110	0.130	2.80	3.30
L	0.295	0.305	7.50	7.74
M	0°	10°	0°	10°
S	0.020	0.040	0.51	1.01

D SUFFIX PLASTIC SOIC PACKAGE CASE 751B-05 ISSUE J

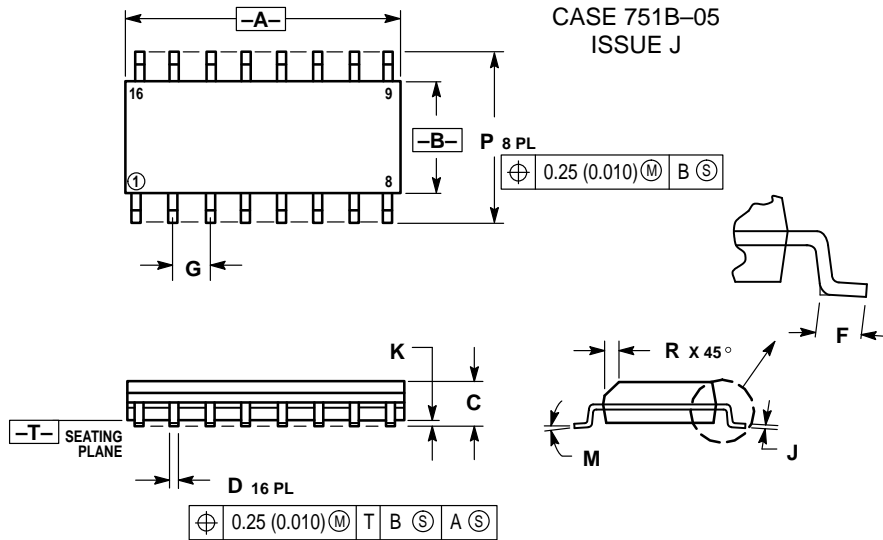

NOTES:

- DIMENSIONING AND TOLERANCING PER ANSI Y14.5M, 1982.
- CONTROLLING DIMENSION: MILLIMETER.
- DIMENSIONS A AND B DO NOT INCLUDE MOLD PROTRUSION.
- MAXIMUM MOLD PROTRUSION 0.15 (0.006) PER SIDE.
- DIMENSION D DOES NOT INCLUDE DAMBAR PROTRUSION. ALLOWABLE DAMBAR PROTRUSION SHALL BE 0.127 (0.005) TOTAL IN EXCESS OF THE D DIMENSION AT MAXIMUM MATERIAL CONDITION.

DIM	MILLIMETERS		INCHES	
	MIN	MAX	MIN	MAX
A	9.80	10.00	0.386	0.393
B	3.80	4.00	0.150	0.157
C	1.35	1.75	0.054	0.068
D	0.35	0.49	0.014	0.019
F	0.40	1.25	0.016	0.049
G	1.27 BSC		0.050 BSC	
J	0.19	0.25	0.008	0.009
K	0.10	0.25	0.004	0.009
M	0°	7°	0°	7°
P	5.80	6.20	0.229	0.244
R	0.25	0.50	0.010	0.019

Motorola reserves the right to make changes without further notice to any products herein. Motorola makes no warranty, representation or guarantee regarding the suitability of its products for any particular purpose, nor does Motorola assume any liability arising out of the application or use of any product or circuit, and specifically disclaims any and all liability, including without limitation consequential or incidental damages. "Typical" parameters can and do vary in different applications. All operating parameters, including "Typicals" must be validated for each customer application by customer's technical experts. Motorola does not convey any license under its patent rights nor the rights of others. Motorola products are not designed, intended, or authorized for use as components in systems intended for surgical implant into the body, or other applications intended to support or sustain life, or for any other application in which the failure of the Motorola product could create a situation where personal injury or death may occur. Should Buyer purchase or use Motorola products for any such unintended or unauthorized application, Buyer shall indemnify and hold Motorola and its officers, employees, subsidiaries, affiliates, and distributors harmless against all claims, costs, damages, and expenses, and reasonable attorney fees arising out of, directly or indirectly, any claim of personal injury or death associated with such unintended or unauthorized use, even if such claim alleges that Motorola was negligent regarding the design or manufacture of the part. Motorola and  are registered trademarks of Motorola, Inc. Motorola, Inc. is an Equal Opportunity/Affirmative Action Employer.

How to reach us:

USA/EUROPE: Motorola Literature Distribution;
P.O. Box 20912; Phoenix, Arizona 85036. 1-800-441-2447

JAPAN: Nippon Motorola Ltd.; Tatsumi-SPD-JLDC, Toshikatsu Otsuki,
6F Seibu-Butsuryu-Center, 3-14-2 Tatsumi Koto-Ku, Tokyo 135, Japan. 03-3521-8315

MFAX: RMFA00@email.sps.mot.com -TOUCHTONE (602) 244-6609
INTERNET: http://Design-NET.com

HONG KONG: Motorola Semiconductors H.K. Ltd.; 8B Tai Ping Industrial Park,
51 Ting Kok Road, Tai Po, N.T., Hong Kong. 852-26629298



MC74AC194/D

