

NEW

OMRON

LED Lighting System 3Z4S-LT/LE Series Datasheet



LED NEXT GENERATION



realizing

This document provides information mainly for selecting suitable models. Please read the Instruction Sheet carefully for information that the user must understand and accept before purchase, including information on warranty, limitations of liability, and precautions.

OMRON Corporation Industrial Automation Company

Tokyo, JAPAN Contact: www.ia.omron.com

Regional Headquarters

OMRON EUROPE B.V.
Wegalaan 67-69-2132 JD Hoofddorp
The Netherlands
Tel: (31)2356-81-300/Fax: (31)2356-81-388

OMRON ASIA PACIFIC PTE. LTD.
No. 458A Alexandra Road # 05-05/06 (Lobby 2)
Alexandra Technopark,
Singapore
Tel: (65) 6885-5011/Fax: (65) 6885-2711

OMRON (CHINA) CO., LTD.
Room 2211, Bank of China Tower,
200 Ym Chong Zhong Road,
JIDONG NEW LIGHTING CITY
Tel: (86) 21-5397-2222/Fax: (86) 21-5397-2200

Tel: (1) 847-843-7100/Fax: (1) 847-843-7787

© OMRON Corporation 2009. All Rights Reserved.
In the U.S.A.:
Specifications are subject to change without notice.
CSM-2-1-0511 Printed in Japan
Cat. No. O164-E1-01 0708

Authorized Distributor:

Next-generation MG-Wave® LED Illumination Combines with the Vision Sensor to Provide New Solutions

Illumination Devices are essential for finding solutions to many of the image-processing tasks of Vision Sensors. With this in mind, we have now combined advanced MG-Wave® LED Illumination from the broad Moritex range of original and innovative products based on superior illumination technologies with Vision Sensor image-processing technologies and know-how accumulated over the years by OMRON.

This powerful collaboration has yielded a variety of optimal solutions to inspection and measurement needs in automated production applications.

A wide range of products allows you to select the optimal Illumination Device for each application.



Index

Strobe Controller	P4
Direct Ring Light	P6
Low Angle Ring Light	P7
Coaxial Light/Simulated Coaxial Episcopic Light	P8
Shadowless Light	P9
Bar Light/Line Light	P10
Dome Light	P11
High-powered Spot LED Light	P11
IR Light	P12
Direct Backlight	P13
Edge-type Backlight	P14
Square Oblique Light	P15
UV Light	P16
Spot LED Light	P17
Parallel Light	P17
CCTV Lens	P18
CCTV Lens Option	P19
Non-telecentric Macro Lens	P19
New Power Supplies for MCEP/MSPP Series	P20
New Power Supplies for MG-Wave Series	P22
Optional Accessories	P25

Strobe Controller

3Z4S-LT MLEK-C080E1LS (for F150-S1A, F160-S2 Camera)
 3Z4S-LT MLEK-C100E1TS2 (for FZ Camera)
 3Z4S-LT MLEK-C100E1TSX (for ZFX-S/SC Camera)

Combining good Vision Sensor compatibility and excellent cost-performance.



Three Main Features

No need of power supply.

The Strobe Controller operates with power supplied from the Camera Head.

No need of light-emission control.

The illumination is turned ON when the Strobe Controller receives a trigger signal from the Camera Head.

Minimal wiring.

Simply connect the Camera and Illumination Device with a single cable.

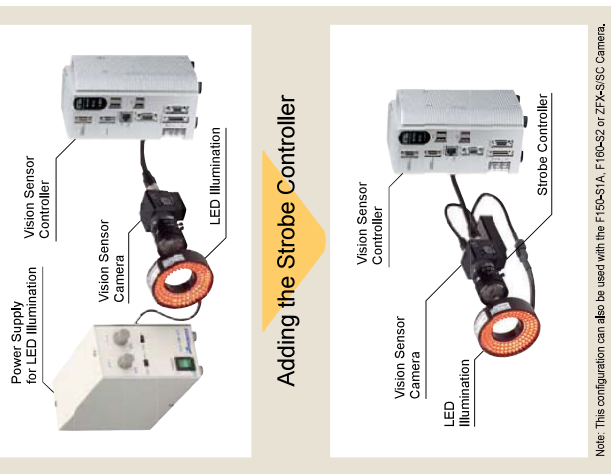

Note: This configuration can also be used with the F150-S1A, F160-S2 or ZFX-S/SC Camera.

Illumination Devices up to 1 A (Output current: See note) can be connected.



Ratings and Specifications

The strobe intensity can be manually adjusted.

Model	3Z4S-LT MLEK-C080E1LS (See note 1)	3Z4S-LT MLEK-C100E1TS2	3Z4S-LT MLEK-C100E1TSX
No. of outputs	1-channel output		
Output current	1.0 A max. (when using 1-D-A illumination) (See note 2)		
Output control method	Constant current control		
Output form	Strobe output (synchronized with rising edge trigger)		
Output adjustment function	Manual dial only		
Variable output range	0 to 100%		
Strobe emission time	6.3 ms (standard)		
Strobe emission delay time	Ton: 30 μs max. (at max. setting) Toff: 10 μs max. (at max. setting)		
Allowable ON duty	100%		
Usage environment	Indoor use at a max. altitude of 12,000 m, with no inflammable or corrosive gases present, and no adhesion of foreign matter		
Ambient temperature and humidity	0 to 45°C, 80% up to 31°C and then dropping linearly to 50% at 40°C		
Storage temperature and humidity	-20 to 85°C, 20 to 80% humidity (with no condensation)		
Mounting method	Connected and mounted to F160-S2 or F150-S1 Camera Connected and mounted to FZS-ZFX-S-2M Camera Connected and mounted to ZFX-S/SC Camera		
Cooling method	Natural air cooling		
Degree of protection	IP30 (IEC 60529)		
Weight	Approx. 80 g		
Extension Cable (purchased separately)	MLRCB4 (L) (4-pin Extension Cable) (indicate length in the 2 square boxes (L1): 01=1m, 02=2 m, 03=3 m)		

Note 1: Illumination marked with * in the Connection to Strobe Controller column of the Model Number Legend table can be used.
 Note 2: Depends on the illumination used.
 Note 3: Strobe intensity adjustment and variable ranges.

Dimensions

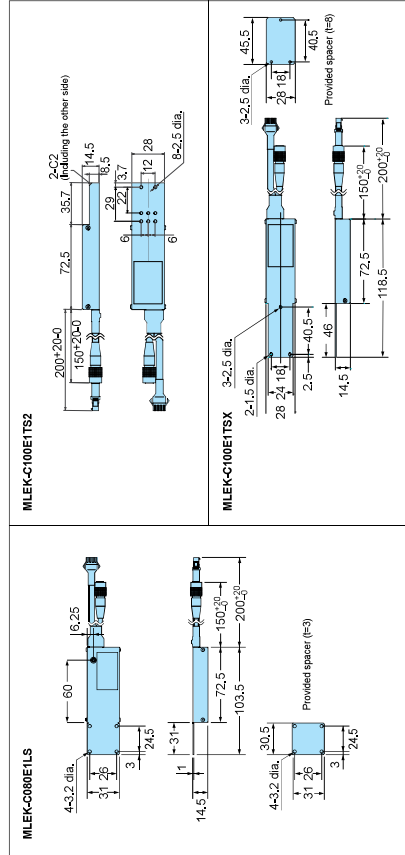

Direct Ring Light



Model Number Legend

3Z4S-LT MDRL-C * ○ ○ ○ ○
 Luminescent color (Red=R, Green=G, Blue=B, White=W)
 Internal diameter of the ring (mm)

List of Models

Model	Dimension	Luminescent Color	Max. rated current I _{FM} (A)	Weight (g)	Power supply	Connection to strobe controller
MDRL-CR10	A	Red	0.11		080	○
MDRL-CG10	A	Green	0.17		080	○
*MDRL-CB10	A	Blue	0.17	50	080	○
MDRL-CW10	A	White	0.17		080	○
MDRL-CR16	B	Red	0.24		080	○
*MDRL-CG16	B	Green	0.37	65	080	○
MDRL-CB16	B	Blue	0.37		080	○
MDRL-CW16	B	White	0.37		080	○
MDRL-CR28	C	Red	0.20		080	○
*MDRL-CG28	C	Green	0.31	65	080	○
MDRL-CB28	C	Blue	0.31		080	○
MDRL-CW28	C	White	0.31		080	○
MDRL-CR31	D	Red	0.36		080	○
*MDRL-CG31	D	Green	0.55	130	080	○
MDRL-CB31	D	Blue	0.55		080	○
MDRL-CW31	D	White	0.55		080	○
MDRL-CR35	E	Red	0.34		080	○
*MDRL-CG35	E	Green	0.52	150	080	○
MDRL-CB35	E	Blue	0.52		080	○
MDRL-CW35	E	White	0.52		080	○
MDRL-CR36	F	Red	0.36		080	○
*MDRL-CG36	F	Green	0.55	120	080	○
MDRL-CB36	F	Blue	0.55		080	○
MDRL-CW36	F	White	0.55		080	○
MDRL-CR50	G	Red	0.64		080	○
*MDRL-CG50	G	Green	0.96	180	230	×
MDRL-CB50	G	Blue	0.96		230	×
MDRL-CW50	G	White	0.96		230	×
MDRL-CR56	H	Red	1.12		230	×
*MDRL-CG56	H	Green	1.55	520	230	×
MDRL-CB56	H	Blue	1.55		230	×
MDRL-CW56	H	White	1.55		230	×

* Production by order

The recommended working distance is 60 mm or larger, and a reflective surface is being illuminated, the working distance can be as long as 200 mm.

Options

Diffusion and Polarizing plates are available to prevent the vignetting of image.

For detail, see "Adapter: MAD Series" on page 25.

Dimensions

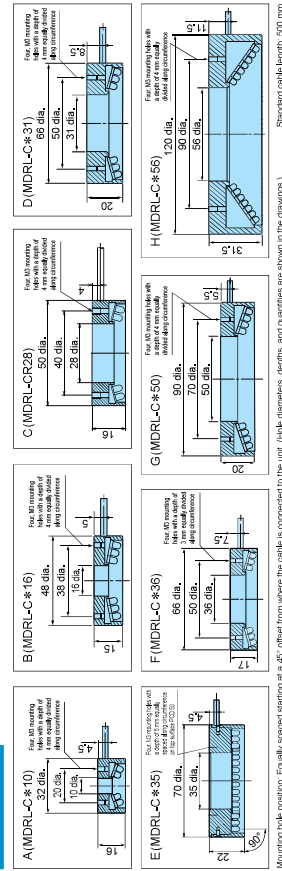

Mounting hole position: Equally spaced starting at a 45° offset from where the cable is connected to the unit. (Hole diameters, depths, and quantities are shown in the drawings.) Standard cable length: 500 mm

Low Angle Ring Light



Model Number Legend

3Z4S-LT MLRL-C * ○ ○ ○ ○
 Luminescent color (Red=R, Green=G, Blue=B, White=W)
 Internal diameter of the ring (mm)

List of Models

Model	Dimension	Luminescent Color	Max. rated current I _{FM} (A)	Weight (g)	Power supply	Connection to strobe controller
MLRL-CR25	A	Red	0.15		080	○
*MLRL-CG25	A	Green	0.24		080	○
MLRL-CB25	A	Blue	0.24	70	080	○
MLRL-CW25	A	White	0.24		080	○
MLRL-CR46	B	Red	0.17		080	○
*MLRL-CG46	B	Green	0.27	80	080	○
MLRL-CB46	B	Blue	0.27		080	○
MLRL-CW46	B	White	0.27		080	○
MLRL-CR48	C	Red	0.30		080	○
*MLRL-CG48	C	Green	0.47		080	○
MLRL-CB48	C	Blue	0.47	110	080	○
MLRL-CW48	C	White	0.47		080	○
MLRL-CR88	D	Red	0.57		080	○
*MLRL-CG88	D	Green	0.61		080	○
MLRL-CB88	D	Blue	0.61	190	080	○
MLRL-CW88	D	White	0.61		080	○
MLRL-CR100	E	Red	0.56		230	×
*MLRL-CG100	E	Green	1.03	330	230	×
MLRL-CB100	E	Blue	1.03		230	×
MLRL-CW100	E	White	1.03		230	×

* Production by order

Options

Good for producing more uniform illumination than with direct lighting and for reducing glare and reflections.

Diffusion ring



Model	Applicable model
MDF-LR25	MLRL-C (R,G,B,W) 25
MDF-LR48	MLRL-C (R,G,B,W) 48
MDF-LR88	MLRL-C (R,G,B,W) 88
MDF-LR100	MLRL-C (R,G,B,W) 100

Dimensions

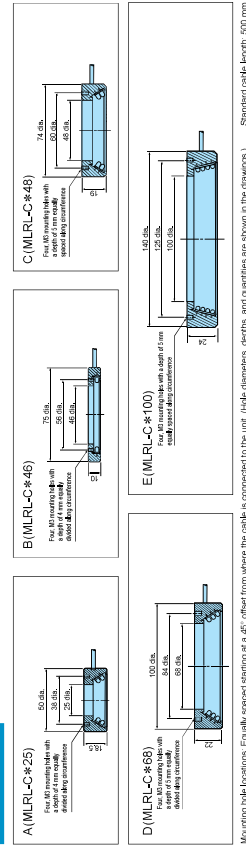

Mounting hole position: Equally spaced starting at a 45° offset from where the cable is connected to the unit. (Hole diameters, depths, and quantities are shown in the drawings.) Standard cable length: 500 mm

Coaxial Light/Simulated Coaxial Episcopic Light

MCEL Series
MSCL series



Model Number Legend

Coaxial
3Z4S-LT MCEL-C * ○ ○ ○ ○ ○
Luminescent color (Red=R, Green=G, Blue=B, White=W)

Simulated Coaxial
3Z4S-LT MSCL-C * ○ ○ ○ ○ ○ - *
Luminescent color (Red=R, Green=G, Blue=B, White=W)

List of Models

Lineup of Coaxial Light					
Model	Dimension	Luminescent Color	Max. rated current I _{FM} (A)	Weight (g)	Power supply
MCEL-CR8	A	Red	0.04	080	Connection to strobe controller
MCEL-CG8	A	Green	0.03	080	X
MCEL-CB8	A	Blue	0.03	080	X
MCEL-CW8	A	White	0.03	080	X

Lineup of Simulated Coaxial Episcopic Light					
Model	Dimension	Luminescent Color	Max. rated current I _{FM} (A)	Weight (g)	Power supply
MSCL-CR24	B	Red	0.09	080	Connection to strobe controller
* MSCL-CG24	B	Green	0.20	110	
MSCL-CB24	B	Blue	0.20	080	
MSCL-CW24	B	White	0.20	080	
MSCL-CR39	C	Red	0.16	080	
* MSCL-CG39	C	Green	0.31	160	
MSCL-CB39	C	Blue	0.31	080	
MSCL-CW39	C	White	0.31	080	
MSCL-CR46	D	Red	0.23	080	
* MSCL-CG46	D	Green	0.66	320	
MSCL-CB46	D	Blue	0.66	080	
MSCL-CW46	D	White	0.66	080	
* MSCL-CR74-B	E	Red	0.62	080	
MSCL-CG74-B	E	Green	1.11	530	
MSCL-CB74-B	E	Blue	1.11	080	
MSCL-CW74-B	E	White	1.11	080	
MSCL-CR74-A	F	Red	2.14	230	
* MSCL-CG105-B'	F	Green	2.07	920	
MSCL-CB105-B'	F	Blue	2.07	230	
MSCL-CW105-B'	F	White	2.07	230	

*Always turn the cooling fan to prevent heat buildup. This is in addition to the normal Extension Cable. [Click here for more info.](#)
 * Production by order.

Dimensions

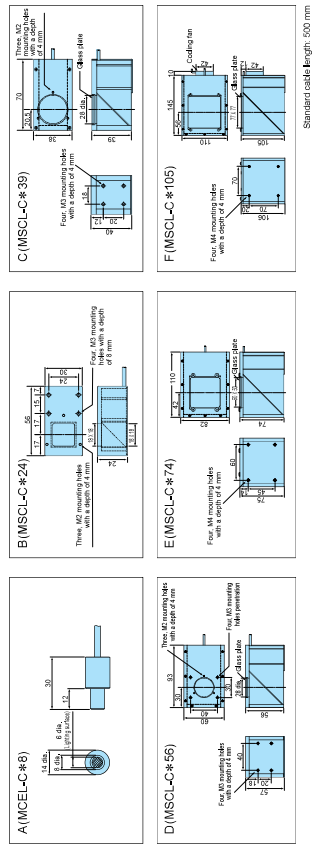

Shadowless Light

MSRL Series
MSLL Series
MSQL Series



Model Number Legend

Shadowless
3Z4S-LT MSRL-C * ○ ○ ○ ○ ○
Luminescent color (Red=R, Green=G, Blue=B, White=W)

Shadowless Low Angle Ring
3Z4S-LT MSLL-C * ○ ○ ○ ○ ○
Luminescent color (Red=R, Green=G, Blue=B, White=W)

Shadowless Low Angle Square
3Z4S-LT MSQL-C * ○ ○ ○ ○ ○
Luminescent color (Red=R, Green=G, Blue=B, White=W)

List of Models

Line up of Shadowless					
Model	Dimension	Luminescent Color	Max. rated current I _{FM} (A)	Weight (g)	Power supply
MSRL-CR20	A	Red	0.32	080	Connection to strobe controller
* MSRL-CG20	A	Green	0.50	140	
MSRL-CB20	A	Blue	0.50	080	
MSRL-CW20	A	White	0.50	080	
MSRL-CR33	B	Red	0.45	080	
* MSRL-CG33	B	Green	0.69	210	
MSRL-CB33	B	Blue	0.69	080	
MSRL-CW33	B	White	0.69	080	
MSRL-CR44	C	Red	0.57	080	
* MSRL-CG44	C	Green	0.80	270	
MSRL-CB44	C	Blue	0.80	080	
MSRL-CW44	C	White	0.80	080	

Line up of Shadowless Low Angle Ring					
Model	Dimension	Luminescent Color	Max. rated current I _{FM} (A)	Weight (g)	Power supply
MSLL-CR109	D	Red	0.62	080	Connection to strobe controller
* MSLL-CG109	D	Green	1.10	330	
MSLL-CB109	D	Blue	1.10	230	
MSLL-CW109	D	White	1.10	230	

Line up of Shadowless Low Angle Square					
Model	Dimension	Luminescent Color	Max. rated current I _{FM} (A)	Weight (g)	Power supply
MSQL-CR32	E	Red	0.09	080	Connection to strobe controller
* MSQL-CG32	E	Green	0.14	80	
MSQL-CB32	E	Blue	0.14	080	
MSQL-CW32	E	White	0.14	080	
MSQL-CR46	F	Red	0.13	080	
* MSQL-CG46	F	Green	0.20	120	
MSQL-CB46	F	Blue	0.20	080	
MSQL-CW46	F	White	0.20	080	

Dimensions

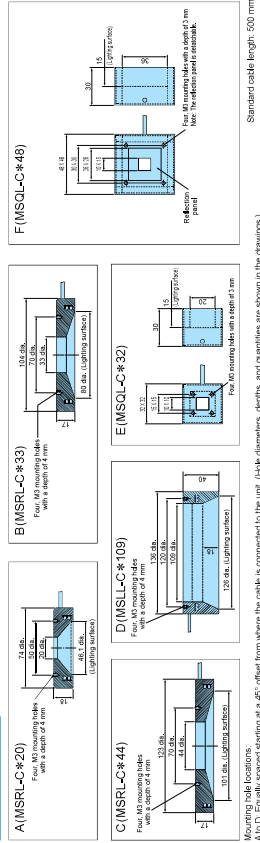

Bar Light/Line Light

MBRL Series
MLNL Series

Model Number Legend

MBRL Series

3Z4S-LT MBRL-C *
Luminiscent color (Red=R, Green=G, Blue=B, White=W)

MLNL Series

3Z4S-LT MLNL-C *
Luminiscent color (Red=R, Green=G, Blue=B, White=W)

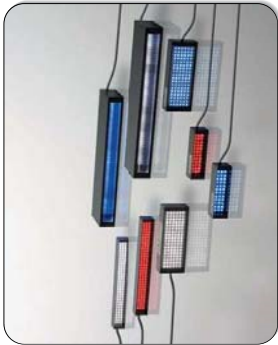

List of Models

Model	Dimension	Luminiscent Color	Max. rated current IFM (A)	Weight (g)	Power supply	Connection to strobe controller
MBRL-CR015	A	Red	0.13	90	090	○
* MBRL-CG015	A	Green	0.26	90	090	○
MBRL-CB015	A	Blue	0.26	50	090	○
MBRL-CW015	A	White	0.26	90	090	○
MBRL-CR750	B	Red	0.36	90	090	○
* MBRL-CG750	B	Green	0.52	120	090	○
MBRL-CB750	B	Blue	0.52	90	090	○
MBRL-CW750	B	White	0.52	90	090	○
* MBRL-CR13015	C	Red	0.32	90	090	○
MBRL-CG13015	C	Green	0.53	85	090	○
MBRL-CB13015	C	Blue	0.53	90	090	○
MBRL-CW13015	C	White	0.53	90	090	○

Lineup of Bar Light

Model	Dimension	Luminiscent Color	Max. rated current IFM (A)	Weight (g)	Power supply	Connection to strobe controller
MLNL-CR192	D	Red	0.18	900	090	○
* MLNL-CG192	D	Green	0.36	900	090	○
MLNL-CB192	D	Blue	0.36	470	090	○
MLNL-CW192	D	White	0.36	900	090	○

* Production by ower

Dimensions

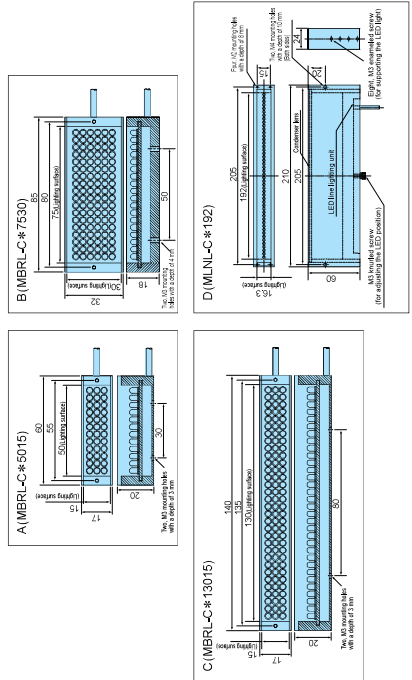

Mounting hole location:
A to C: Arranged around the center of the mounting surface.

Standard cable length: 500 mm

Dome Light

MDML Series

Model Number Legend

3Z4S-LT MDML-C *
Luminiscent color (Red=R, Green=G, Blue=B, White=W)

Dimensions

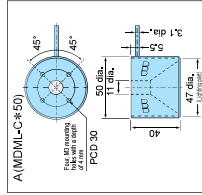

List of Models

Model	Dimension	Luminiscent Color	Max. rated current IFM (A)	Weight (g)	Power supply	Connection to strobe controller
MDML-CR50	A	Red	0.24	80	090	○
* MDML-CG50	A	Green	0.37	130	090	○
MDML-CB50	A	Blue	0.37	80	090	○
MDML-CW50	A	White	0.37	80	090	○
MDML-CR150	B	Red	1.16	230	230	X
MDML-CG150	B	Green	1.46	1800	230	X
MDML-CB150	B	Blue	1.46	230	230	X
MDML-CW150	B	White	1.46	230	230	X

* Production by ower

Standard cable length: 500 mm

High-powered Spot LED Light

MCEP Series

Model Number Legend

3Z4S-LT MCEP-C * 8
Luminiscent color (Red=R, Green=G, Blue=B, White=W)

Dimensions

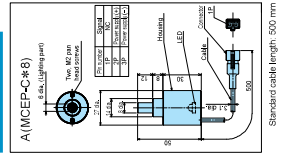

Standard cable length: 500 mm

Removing the Point Rod

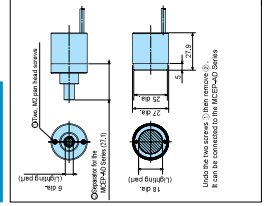

List of Models

Model	Dimension	Dominant wavelength	Color temperature	Max. rated current IFM (A)	Weight (g)	Connection to strobe controller
MCEP-CR8	A	Red	620.5 ~ 645nm	-	0.35	X
MCEP-CG8	A	Green	525 ~ 535nm	-	0.35	X
MCEP-CB8	A	Blue	470 ~ 480nm	-	0.35	X
MCEP-CW8	A	White	All	5000 ~ 6000K	0.35	X

* The dominant wavelength varies color according to IIE color coordinates. There are differences in the luminous spot for the same rated power.
* Weights of these LEDs. Colors may appear to be different even for the same model number.

High-power LED

Dome Light

IR Light

MDRL Series
MSRL Series
MBRL Series
MDBL Series

Model Number Legend



List of Models

Model	Dimension	Luminiscent Color	Max. rated current (PM (A))	Weight (g)	Power supply	Connection to strobe controller
MDRL-CIR31	A	Infrared	0.42	130	080	○
MSRL-CIR20	B	Infrared	0.36	140	080	○
MBRL-CIR750	C	Infrared	0.40	120	080	○
MDBL-CIR70	D	Infrared	0.53	160	080	○

*The dominant wavelength of visible color according to CIE color coordinates. There are differences in the luminiscent color for the dominant wavelengths of these LEDs. Colors may appear to be different even for the same model number.

Dimensions

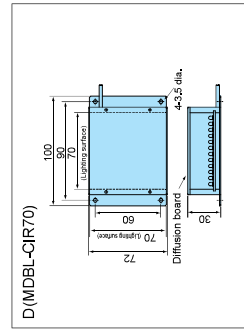
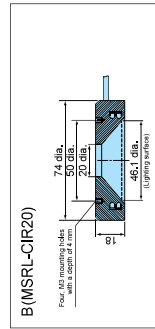
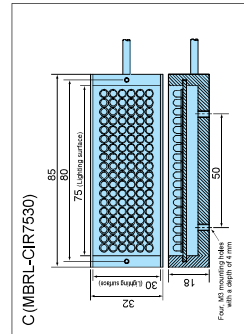
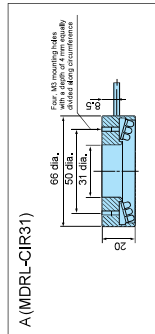

Mounting hole locations:
A and B: Equally spaced starting at a 4.5° offset from where the cable is connected to the unit. (Hole diameters, depths, and quantities are shown in the drawings.)
C: Arranged around the center of the mounting surface.

Direct Backlight

MDBL Series
MDBC Series

Model Number Legend

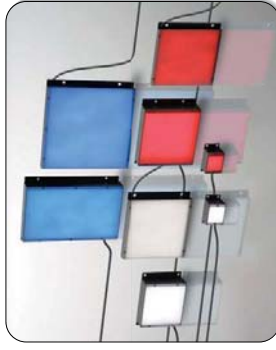
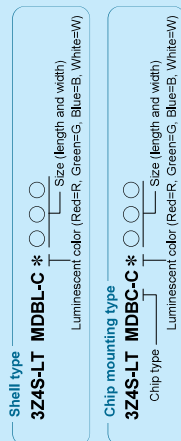

List of Models

Lineup of Shell type

Model	Dimension	Luminiscent Color	Max. rated current (PM (A))	Weight (g)	Power supply	Connection to strobe controller
MDBL-CR25	A	Red	0.14		080	○
* MDBL-CG25	A	Green	0.27	60	080	○
MDBL-CB25	A	Blue	0.27		080	○
MDBL-CW25	A	White	0.27		080	○
MDBL-CR70	B	Red	0.48		230	×
* MDBL-CG70	B	Green	0.96	160	230	×
MDBL-CB70	B	Blue	0.96		230	×
MDBL-CW70	B	White	0.96		230	×
MDBL-CR100	C	Red	1.43		230	×
* MDBL-CG100	C	Green	1.55	290	230	×
MDBL-CB100	C	Blue	1.55		230	×
MDBL-CW100	C	White	1.55		230	×
MDBL-CR180	D	Red	2.30		230	×
* MDBL-CG180	D	Green	2.30	520	230	×
MDBL-CB180	D	Blue	2.30		230	×
MDBL-CW180	D	White	2.30		230	×

Lineup of Chip mounting type

Model	Dimension	Luminiscent Color	Max. rated current (PM (A))	Weight (g)	Power supply	Connection to strobe controller
MDBC-CR100	E	Red	0.81		230	×
* MDBC-CG100	E	Green	0.81		230	×
MDBC-CB100	E	Blue	0.81	170	230	×
MDBC-CW100	E	White	0.81		230	×
MDBC-CR160	F	Red	0.96		230	×
* MDBC-CG160	F	Green	2.14		230	×
MDBC-CB160	F	Blue	2.14	310	230	×
MDBC-CW160	F	White	2.14		230	×

* Protection by water

Dimensions

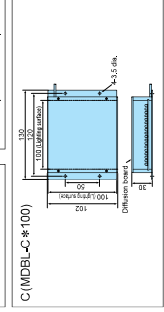
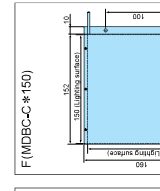
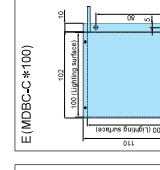
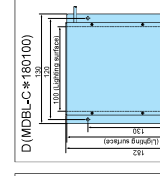
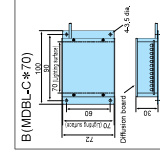
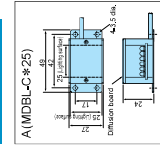

Standard cable length: 500 mm

Square Oblique Light

Model Number Legend

3Z4S-LT MDQL-C * ○ ○ ○ ○ ○

External size
Luminiscent color (Red=R, Green=G, Blue=B, White=W)

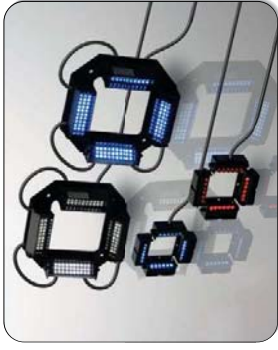

List of Models

Model	Dimension	Luminiscent Color	Max. rated current (F/M) (A)	Weight (g)	Power supply	Connection to strobe controller
MDQL-CR89	A	Red	0.09		090	○
* MDQL-CG89	A	Green	0.17	55	090	○
MDQL-CB89	A	Blue	0.17		090	○
MDQL-CW89	A	White	0.17		090	○
MDQL-CR108	B	Red	0.42		230	○
* MDQL-CG108	B	Green	0.64	210	230	X
MDQL-CB108	B	Blue	0.64		230	X
MDQL-CW108	B	White	0.64		230	X

* Production by order

Dimensions

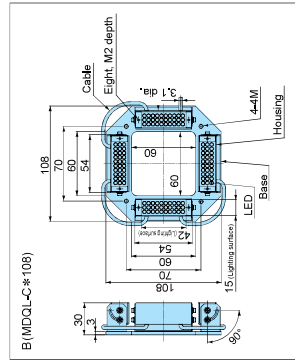
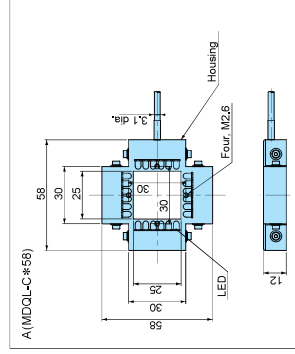

Standard cable length: 500 mm

Edge-type Backlight

Model Number Legend

3Z4S-LT MEBL-C * ○ ○ ○ ○ ○

Size (length and width)
Luminiscent color (Red=R, Green=G, Blue=B, White=W)



List of Models

Model	Dimension	Luminiscent Color	Max. rated current (F/M) (A)	Weight (g)	Power supply	Connection to strobe controller
MEBL-CR25	A	Red	0.03		090	○
* MEBL-CG25	A	Green	0.04	45	090	○
MEBL-CB25	A	Blue	0.04		090	○
MEBL-CW25	A	White	0.04		090	○
MEBL-CR50	B	Red	0.17		090	○
* MEBL-CG50	B	Green	0.29	110	090	○
MEBL-CB50	B	Blue	0.29		090	○
MEBL-CW50	B	White	0.29		090	○
MEBL-CR100	C	Red	0.15		090	○
* MEBL-CG100	C	Green	0.25	140	090	○
MEBL-CB100	C	Blue	0.25		090	○
MEBL-CW100	C	White	0.25		090	○
MEBL-CR100B	D	Red	0.32		090	○
* MEBL-CG100B	D	Green	0.57	230	090	○
MEBL-CB100B	D	Blue	0.57		090	○
MEBL-CW100B	D	White	0.57		090	○
MEBL-CR145	E	Red	0.45		090	○
* MEBL-CG145	E	Green	0.8	460	090	○
MEBL-CB145	E	Blue	0.8		090	○
MEBL-CW145	E	White	0.8		090	○

* Production by order

Dimensions

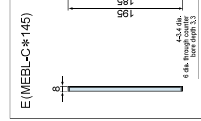
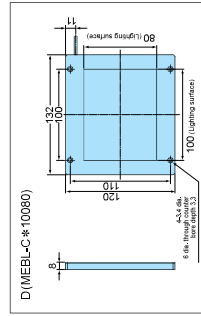
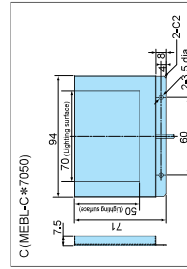
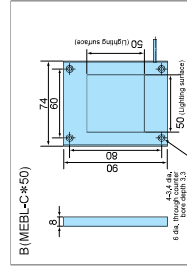
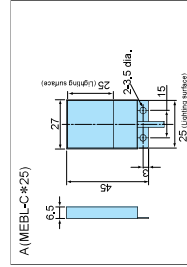

Standard cable length: 500 mm

UV Light

MDRL Series
MBRL Series
MDQL Series

Model Number Legend

3Z4S-LT M □ □ L - C UV ○ ○ ○ ○

□ Direct ring
□ Bre-Bar
□ DO-Square oblique

○ See the explanation of each series model.
○ Luminescent color (Ultra violet-CUV)

List of Models

Model	Dimension	Weight (g)	Max. rated current (RM/A)	Power supply	Conversion to other color
MBRL-CUV31	A	130	0.26	080	○
MBRL-CUV7530	B	120	0.26	080	○
MDQL-CUV108	C	210	0.26	080	○

Dimensions

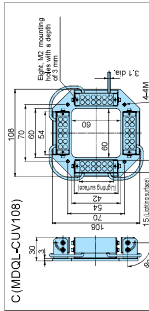
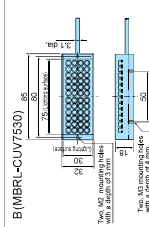
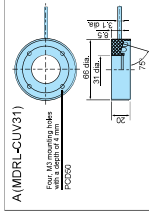

Mounting hole locations:
A: Equally spaced starting at a 45° offset from where the cable is connected to this unit. (Hole diameters, depths, and quantities are shown in the drawings.)
B: Arranged around the center of the mounting surface.
Standard cable length: 500 mm

Spot Led Light

MSPP Series
(CE Marking)



Model Number Legend

3Z4S-LT MSPP-C * ○ ○ ○

○ Effective size (Lighting part)
○ Luminescent color (Red=R, White=W)

List of Models

Model	Dimension	Weight (g)	Max. rated current (RM/A)	Power supply	Conversion to other color
MSPP-CRM2	A	0.7	465g	MLEPA-070 series	X
MSPP-CW42	A	0.7	465g	MLEPA-070 series	X

Model	Dimension	Weight (g)	Max. rated current (RM/A)	Power supply	Conversion to other color
MSPP-CRW4	B	0.7	500g	MLEPA-070 series	X
MSPP-CW74	B	0.7	500g	MLEPA-070 series	X

*Always connect a Conversion Cable (3Z4S-LT-MCSP01Y8) when connecting the power supply.

Dimensions

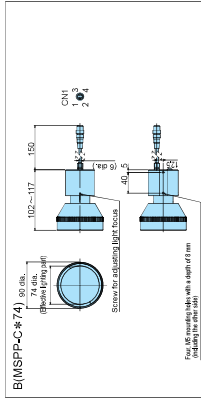
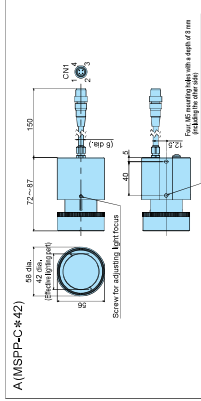

Four M3 mounting holes with a depth of 2 mm

Parallel Light

MCBP Series



Model Number Legend

3Z4S-LT MCBP-C * ○ ○ ○ ○

○ Size (length and width)
○ Luminescent color (Red=R, White=W)

List of Models

Model	Dimension	Weight (g)	Max. rated current (RM/A)	Power supply	Conversion to other color
* MCBP-CB3430	A	0.07	0.07	080	X
MCBP-CB3430	A	0.07	0.07	080	X
MCBP-CW3430	A	0.07	0.07	080	X

Dimensions

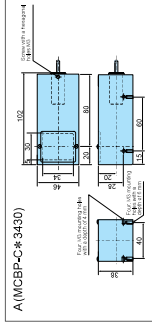

* Production by order

CCTV Lens

ML Series



List of Models

Model	Dimension	Focal distance (mm)	F-number (F No.)	Field of view (V x H)	Closest distance (m)	Filter screw	Weight (g)	Total length (mm)	Maximum diameter (mm)	Camera Mount
3Z4S-LE-ML-0614	A	6	F1.4 - Close	42.3° x 54.6°	0.2	M27 P0.5	60	34.5	30	1/2 inch
3Z4S-LE-ML-0613	B	8	F1.3 - Close	45.0° x 57.6°	0.3	M25.5 P0.5	60	34.5	30	2/3 inch
3Z4S-LE-ML-1214	C	12	F1.4 - Close	21.9° x 29.0°	0.3	M27 P0.5	40	24.5	22	1 inch
3Z4S-LE-ML-1214	D	15	F1.4 - Close	23.0° x 30.4°	0.4	M27 P0.5	45	24.5	22	1 inch
3Z4S-LE-ML-2514	E	25	F1.8 - Close	21.8° x 28.5°	0.5	M27 P0.5	60	29	23	2/3 inch
3Z4S-LE-ML-3519	F	35	F1.8 - Close	16.8° x 14.4°	1	M25.5 P0.5	65	43.5	43.8	2/3 inch
3Z4S-LE-ML-5018	G	50	F2.7 - Close	7.9° x 10.3°	1	M25.5 P0.5	65	43.5	43.8	2/3 inch
3Z4S-LE-ML-7527	H	75	F3.3 - Close	3.9° x 5.1°	1	M25.5 P0.5	65	43.5	43.8	2/3 inch

Dimensions

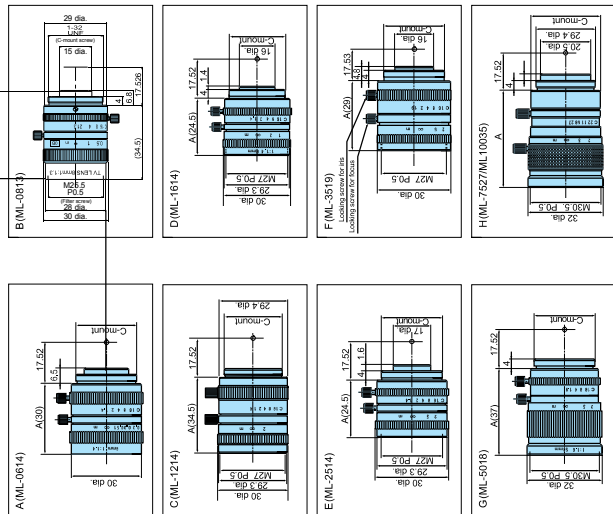

CCTV Lens Option

ML Series

Polarizing Filter

Model	Length (mm)
3Z4S-LE-ML-PZ70	70
3Z4S-LE-ML-PZ35	35
3Z4S-LE-ML-PZ30	30

Close-up Ring

Model	Length (mm)
3Z4S-LE-ML-EXR*	70, 80, 90, 100, 110, 120, 130, 140

*These Close-up Rings are also available individually. Order using the following model number, replacing the box with the desired length: 3Z4S-LE-ML-EXR-1.

Rear Converter Lens

Configuration

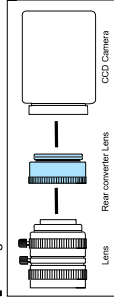

List of Models

Model
3Z4S-LE-ML-1.5X
3Z4S-LE-ML-2X
3Z4S-LE-ML-3X
3Z4S-LE-ML-4X

Non-telecentric Macro Lens

ML-N Series

List of Models

Model	Dimension	Magnification	Element No.	DI (mm)	WD (mm)	Depth of field	Resolution	TV distortion
B (ML05-181N)	A	0.1	4.71	364.5	327.7	37.65mm	33.9lp/mm	0.4% max.
B (ML05-181N)	B	0.3	5.11	240.9	181.3	5.45mm	14.9lp/mm	0.2% max.
B (ML05-181N)	C	0.5	5.08	199	132.5	1.95mm	11.7lp/mm	0.08% max.
B (ML05-181N)	D	1.0	5.82	177.5	89.5	0.7mm	7.9lp/mm	0.05% max.

*The field of depth is calculated based on an image equivalent to 32.0 horizontal TV lines taken with a 1/2" CCD camera.

Dimensions

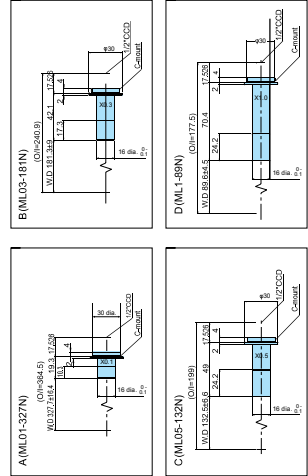

New Power Supplies for MCEP/MSPP Series

These constant-current power supplies are designed specifically for the MCEP Series of High-power LED Spot Lights and MSPP Series of LED Spot Lights.

NEW MLEP Analog Series

Models are available with an analog light adjustment and for either one or three channels. A wide voltage input (100 to 240 VAC) is supported, along with CE Marking.

Ratings and Specifications

Model	MLEP-A035W1LR-100V	MLEP-A035W1LR-200V	MLEP-A035W3LR-100V	MLEP-A035W3LR-200V	MLEP-A070W1LR-100V	MLEP-A070W3LR-100V	MLEP-A070W3LR-200V	
AC Type	100V	200V	100V	200V	100V	100V	200V	
Output	Single-channel out put max.350 mA	Single-channel out put max.350 mA	3-channel out put for each channel max.350 mA	3-channel out put for each channel max.350 mA	Single-channel out put max.700 mA	3-channel out put for each channel max.700 mA	3-channel out put for each channel max.700 mA	
Dimension	A							B
Input voltage	100~240V AC 50/60Hz							100~240V AC 50/60Hz
Input current	0.35 (0.35A (at AC 100/240V))							0.35(0.35 A (at AC 100/240V))
Surge current	20A or lower (at 100V AC) 40A or lower (at 240V AC)							20A or lower (at 100V AC) 40A or lower (at 240V AC)
Operating temperature	0 to +45°C							0 to +45°C
Output system	Continuous DC output							Continuous DC output
Output control system	Constant current control (the current can be changed)							Constant current control (the current can be changed)
External light control	Supported (0 to 5V)							Supported (0 to 5V)
Lighting on/off function	Supported (photocoupler insulation)							Supported (photocoupler insulation)
Cooling system	Natural air cooling							forcible air cooling
Installation	Horizontal installation on the rubber supports at the bottom of the unit							Horizontal installation on the rubber supports at the bottom of the unit
Weight	Approximately 0.3kg							Approximately 1.4kg

Connection Specifications

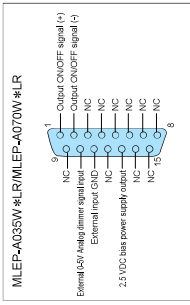

I/O Circuit Diagrams

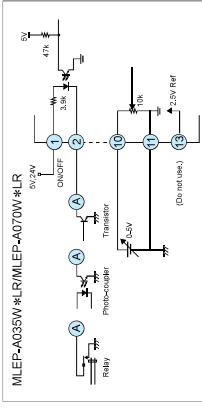

Dimensions

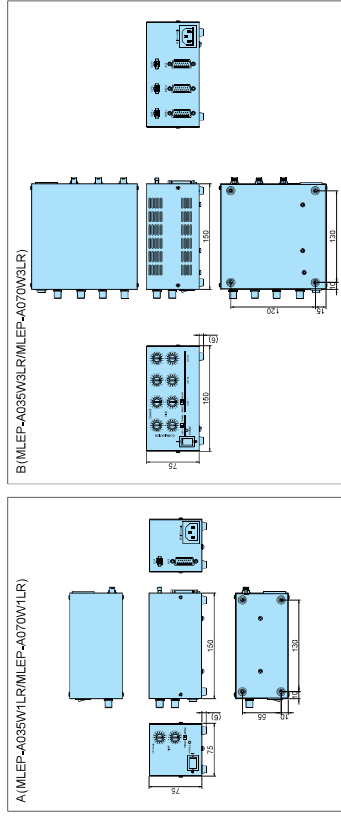

Model Number Legend

3Z4SLT MLEP-A *W*LR* - **V**
 Maximum output current AC type
 Output channel Digital type(D)

NEW MLEP Series



NEW MLEP Digital Series

Models are available with a digital light adjustment and for either one or three channels. A wide voltage input (100 to 240 VAC) is supported, along with CE Marking.

Ratings and Specifications

Model	MLEP-A035W1LR-100V	MLEP-A035W1LR-200V	MLEP-A070W1LR-100V	MLEP-A070W1LR-200V	MLEP-A035W3LR-100V	MLEP-A035W3LR-200V	MLEP-A070W3LR-100V	MLEP-A070W3LR-200V
AC Type	100V	200V	100V	200V	100V	200V	100V	200V
Output	Single-channel out put max.350 mA	Single-channel out put max.350 mA	Single-channel out put max.700 mA	Single-channel out put max.700 mA	3-channel out put for each channel max.350 mA	3-channel out put for each channel max.350 mA	3-channel out put for each channel max.700 mA	3-channel out put for each channel max.700 mA
Dimension	A							B
Input voltage	100~240V AC 50/60Hz							100~240V AC 50/60Hz
Input current	0.35 (0.35A (at AC 100/240V))							0.35(0.35 A (at AC 100/240V))
Surge current	20A or lower (at 100V AC) 40A or lower (at 240V AC)							20A or lower (at 100V AC) 40A or lower (at 240V AC)
Operating temperature	0 to +45°C							0 to +45°C
Output system	Continuous DC output							Continuous DC output
Output control system	Constant current control (the current can be changed)							Constant current control (the current can be changed)
External light control	Supported (8bit digital)							Supported (for each channel, 8bit digital)
Lighting on/off function	Supported (photocoupler insulation)							Supported (photocoupler insulation)
Cooling system	Natural air cooling							forcible air cooling
Installation	Horizontal installation on the rubber supports at the bottom of the unit							Horizontal installation on the rubber supports at the bottom of the unit
Weight	Approximately 0.3kg							Approximately 1.4kg

Connection Specifications

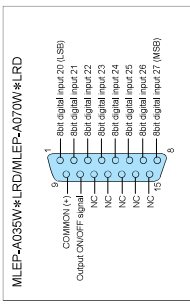

I/O Circuit Diagrams

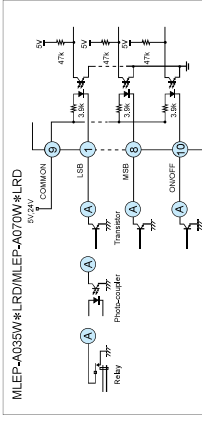

Dimensions

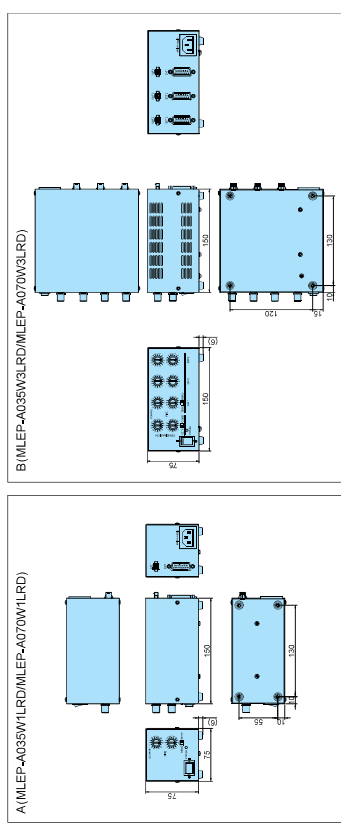



Model Number Legend

3Z4S-LT MLEK-A ***W**LR* - **V
 Maximum output current
 Output channel
 AC type
 Digital type(D)

New Power Supplies for MG-Wave Series

These new power supplies are designed specifically for MG-Wave Constant-current LED Lights (except for the MCEP Series). Even when combining with an LED Light from the broad lineup and possible applications, you can generate the ideal Constant-current Power Supply for the required current consumption. The Power Supplies suppress heat generation and will make the most of the characteristics of any of the LED Light. External output controls and other features are also provided.

A080/230W Analog Series (Total current: 0.8 A or 2.3 A)

Models are available with an analog light adjustment and for either one or two channels. A wide voltage input (100 to 240 VAC) is supported, along with CE Marking, Ratings and Specifications

Model	MLEK-A080W1LR-100V	MLEK-A080W2LR-100V	MLEK-A080W2LR-200V	MLEK-A080W2R-200V
AC Type	100V	100V	200V	200V
Output	Single-channel output of 0.8A (for connection to all lights except the MCEP Series)	Two-channel maximum output of 0.8A for each channel (for connection to all lights except the MCEP Series)	Two-channel maximum output of 0.8A for each channel (for connection to all lights except the MCEP Series)	Two-channel maximum output of 0.8A for each channel (for connection to all lights except the MCEP Series)
Input voltage	100~240V AC 50/60Hz	100~240V AC 50/60Hz	100~240V AC 50/60Hz	100~240V AC 50/60Hz
Dimension	A B			
Input current	0.3 / 0.15A (at AC 100V AC)	0.3 / 0.15A (at AC 100V AC)	0.3 / 0.15A (at AC 100V AC)	0.3 / 0.15A (at AC 100V AC)
Surge current	1.5A or lower (at 100V AC)	1.5A or lower (at 100V AC)	1.5A or lower (at 100V AC)	1.5A or lower (at 100V AC)
Operating temperature	0 to +45°C	0 to +45°C	0 to +45°C	0 to +45°C
Output system	Continuous DC output	Continuous DC output	Continuous DC output	Continuous DC output
Output control system	Constant current control (the current can be changed)	Constant current control (the current can be changed)	Constant current control (the current can be changed)	Constant current control (the current can be changed)
External light control	Supported (photoconductor insulation)	Supported (photoconductor insulation)	Supported (0 to 5V)	Supported (photoconductor insulation)
Error output	Supported (photoconductor insulation, control error)	Supported (photoconductor insulation, control error)	Supported (photoconductor insulation, control error)	Supported (photoconductor insulation, control error)
Cooling system	Natural air cooling	Natural air cooling	Natural air cooling	Natural air cooling
Installation	Horizontal installation on the rubber supports at the bottom of the unit	Horizontal installation on the rubber supports at the bottom of the unit	Horizontal installation on the rubber supports at the bottom of the unit	Horizontal installation on the rubber supports at the bottom of the unit
Weight	Approximately 1.1kg	Approximately 1.3kg	Approximately 1.1kg	Approximately 1.3kg

Model	MLEK-A230W1LR-100V	MLEK-A230W2LR-100V	MLEK-A230W2LR-200V
AC Type	100V	100V	200V
Output	Single-channel output of 2.3A (for connection to all lights except the MCEP Series)	Two-channel maximum output of 2.3A for each channel (for connection to all lights except the MCEP Series)	Two-channel maximum output of 2.3A for each channel (for connection to all lights except the MCEP Series)
Input voltage	100~240V AC 50/60Hz	100~240V AC 50/60Hz	100~240V AC 50/60Hz
Dimension	A B		
Input current	0.7 / 0.4A (at AC 100V AC)	0.7 / 0.4A (at AC 100V AC)	0.7 / 0.4A (at AC 100V AC)
Surge current	1.5A or lower (at 100V AC)	1.5A or lower (at 100V AC)	1.5A or lower (at 100V AC)
Operating temperature	0 to +45°C	0 to +45°C	0 to +45°C
Output system	Continuous DC output	Continuous DC output	Continuous DC output
Output control system	Constant current control (the current can be changed)	Constant current control (the current can be changed)	Constant current control (the current can be changed)
External light control	Supported (0 to 5V dimmer signal / External (VR) input)	Supported (0 to 5V dimmer signal / External (VR) input)	Supported (0 to 5V dimmer signal / External (VR) input)
Lighting on/off function	Supported (photoconductor insulation)	Supported (photoconductor insulation)	Supported (photoconductor insulation)
Error output	Supported (photoconductor insulation, control error)	Supported (photoconductor insulation, control error)	Supported (photoconductor insulation, control error)
Cooling system	Forced air cooling	Forced air cooling	Forced air cooling
Installation	Horizontal installation on the rubber supports at the bottom of the unit	Horizontal installation on the rubber supports at the bottom of the unit	Horizontal installation on the rubber supports at the bottom of the unit
Weight	Approximately 1.1kg	Approximately 1.4kg	Approximately 1.4kg

Connection Specifications

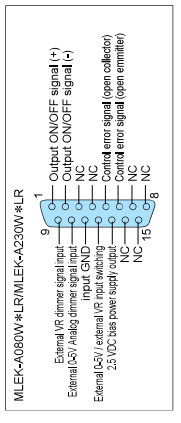

I/O Circuit Diagrams

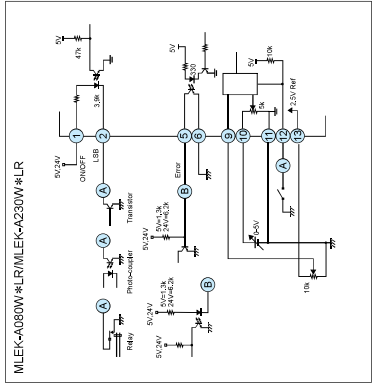

Dimensions

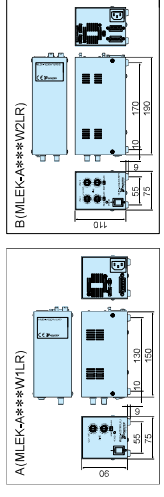

A080/230W Digital Series (Total current: 0.8 A or 2.3 A)

Models are available with a digital light adjustment and for either one or two channels. A wide voltage input (100 to 240 VAC) is supported, along with CE Marking, Ratings and Specifications

Model	MLEK-A080W1LR-100V	MLEK-A080W1LR-200V	MLEK-A080W2LR-100V	MLEK-A080W2LR-200V
AC Type	100V	200V	100V	200V
Output	Single-channel output of 0.8A (for connection to all lights except the MCEP Series)	Single-channel output of 0.8A (for connection to all lights except the MCEP Series)	Two-channel maximum output of 0.8A for each channel (for connection to all lights except the MCEP Series)	Two-channel maximum output of 0.8A for each channel (for connection to all lights except the MCEP Series)
Input voltage	100~240V AC 50/60Hz	100~240V AC 50/60Hz	100~240V AC 50/60Hz	100~240V AC 50/60Hz
Dimension	A B			
Input current	0.3 / 0.15A (at AC 100V AC)	0.3 / 0.15A (at AC 100V AC)	0.3 / 0.15A (at AC 100V AC)	0.3 / 0.15A (at AC 100V AC)
Surge current	1.5A or lower (at 100V AC)	1.5A or lower (at 100V AC)	1.5A or lower (at 100V AC)	1.5A or lower (at 100V AC)
Operating temperature	0 to +45°C	0 to +45°C	0 to +45°C	0 to +45°C
Output system	Continuous DC output	Continuous DC output	Continuous DC output	Continuous DC output
Output control system	Constant current control (the current can be changed)	Constant current control (the current can be changed)	Constant current control (the current can be changed)	Constant current control (the current can be changed)
External light control	Supported (photoconductor insulation)	Supported (photoconductor insulation)	Supported (photoconductor insulation)	Supported (photoconductor insulation)
Error output	Supported (photoconductor insulation, control error)	Supported (photoconductor insulation, control error)	Supported (photoconductor insulation, control error)	Supported (photoconductor insulation, control error)
Cooling system	Natural air cooling	Natural air cooling	Natural air cooling	Natural air cooling
Installation	Horizontal installation on the rubber supports at the bottom of the unit	Horizontal installation on the rubber supports at the bottom of the unit	Horizontal installation on the rubber supports at the bottom of the unit	Horizontal installation on the rubber supports at the bottom of the unit
Weight	Approximately 1.1kg	Approximately 1.1kg	Approximately 1.3kg	Approximately 1.3kg

Model	MLEK-A230W1LR-100V	MLEK-A230W1LR-200V	MLEK-A230W2LR-100V	MLEK-A230W2LR-200V
AC Type	100V	200V	100V	200V
Output	Single-channel output of 2.3A (for connection to all lights except the MCEP Series)	Single-channel output of 2.3A (for connection to all lights except the MCEP Series)	Two-channel maximum output of 2.3A for each channel (for connection to all lights except the MCEP Series)	Two-channel maximum output of 2.3A for each channel (for connection to all lights except the MCEP Series)
Input voltage	100~240V AC 50/60Hz	100~240V AC 50/60Hz	100~240V AC 50/60Hz	100~240V AC 50/60Hz
Dimension	A B			
Input current	0.7 / 0.4A (at AC 100V AC)	0.7 / 0.4A (at AC 100V AC)	0.7 / 0.4A (at AC 100V AC)	0.7 / 0.4A (at AC 100V AC)
Surge current	1.5A or lower (at 100V AC)	1.5A or lower (at 100V AC)	1.5A or lower (at 100V AC)	1.5A or lower (at 100V AC)
Operating temperature	0 to +45°C	0 to +45°C	0 to +45°C	0 to +45°C
Output system	Continuous DC output	Continuous DC output	Continuous DC output	Continuous DC output
Output control system	Constant current control (the current can be changed)	Constant current control (the current can be changed)	Constant current control (the current can be changed)	Constant current control (the current can be changed)
External light control	Supported (0 to 5V dimmer signal / External (VR) input)	Supported (0 to 5V dimmer signal / External (VR) input)	Supported (0 to 5V dimmer signal / External (VR) input)	Supported (0 to 5V dimmer signal / External (VR) input)
Lighting on/off function	Supported (photoconductor insulation)	Supported (photoconductor insulation)	Supported (photoconductor insulation)	Supported (photoconductor insulation)
Error output	Supported (photoconductor insulation, control error)	Supported (photoconductor insulation, control error)	Supported (photoconductor insulation, control error)	Supported (photoconductor insulation, control error)
Cooling system	Forced air cooling	Forced air cooling	Forced air cooling	Forced air cooling
Installation	Horizontal installation on the rubber supports at the bottom of the unit	Horizontal installation on the rubber supports at the bottom of the unit	Horizontal installation on the rubber supports at the bottom of the unit	Horizontal installation on the rubber supports at the bottom of the unit
Weight	Approximately 1.1kg	Approximately 1.1kg	Approximately 1.4kg	Approximately 1.4kg

Connection Specifications

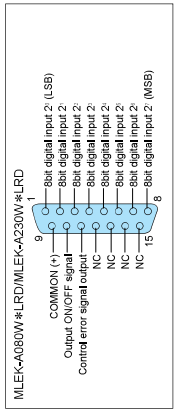

I/O Circuit Diagrams

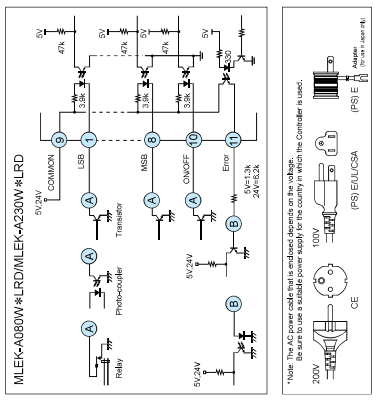

Dimensions

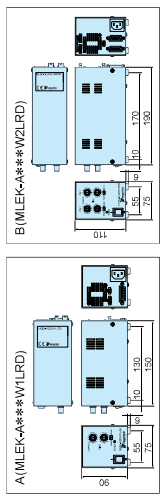

Model Number Legend Multichannel series

3Z4S-LT MLEK-D770W4LRD-***V
AC type



Models are available with a digital light adjustment and for four channels. A wide voltage input (100 to 240 VAC) is supported, along with RoHS compliance. The digital light adjustment provides the previous 6-bit, 256-step control and a new 10-bit, 1,024-step control.
*CE Marking.

Multichannel series

Ratings and Specifications

Model	MLEK-D770W4LRD-100V	MLEK-D770W4LRD-200V
AC Type	100V	200V
Output	4-channel output Total max. 77A (CH1~ CH4 max. 23A CH max. 33A) (for connection to the MCEP Series)	
Input voltage	100~240V AC 50/60Hz	
Dimension	A 170.8 A	
Input current	1.708 A (at AC)	
Surge current	18A or lower (at 100V AC) 41A or lower (at 230V AC)	
Operating temperature	0 to +45°C	
Output system	Continuous DC output	
Output control system	Constant current control (the current can be changed)	
External light control	Supported (for each channel, bit digital or 10 bit digital)	
Lighting on/off function	Supported (photocoupler insulation, control error)	
Error output	Supported (photocoupler insulation, control error) for bit digital	
Cooling system	Forcible air cooling	
Installation	Horizontal installation on the rubber supports at the bottom of the unit	
Weight	Approximately 2kg	

Connection Specifications

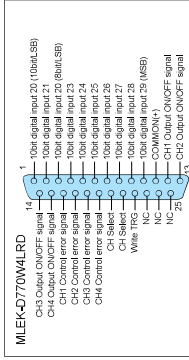

I/O Circuit Diagrams

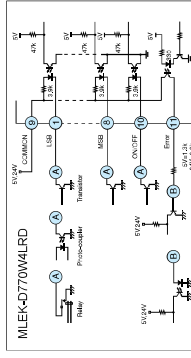

Dimensions

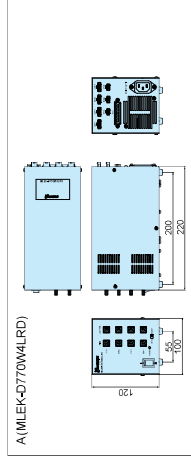

Optional Accessories

*When ordering, provide the specific model number after "SZ4S-LT" (example: SZ4S-LT, MDF-DR10).

Options for lights

The following optional accessories are available to improve the functionality of the lighting devices.

Diffusion plate:MDF Series

The MDF series features a diffusion plate that increases the light diffusion and reduces reflection and glare from the element.

Model	Product type	Compatible light models
MDF-DR10	Square oblique light diffusion plate	MDFL-CR(CG,GB,CW) for 10S_4 pieces/set
MDF-DR16	Diffusion plate for directing lights	MDFL-CR(CG,GB,CW) for 10
MDF-DR16	Diffusion plate for directing lights	MDFL-CR(CG,GB,CW) for 16
MDF-DR28	Diffusion plate for directing lights	MDFL-CR(CG,GB,CW) for 28
MDF-DR31	Diffusion plate for directing lights	MDFL-CR(CG,GB,CW) for 31
MDF-DR50	Diffusion plate for directing lights	MDFL-CR(CG,GB,CW) for 50
MDF-DR56	Diffusion plate for directing lights	MDFL-CR(CG,GB,CW) for 56
MDF-LR25	Diffusion plate for directing lights	MDFL-CR(CG,GB,CW) for 25
MDF-LR48	Diffusion plate for directing lights	MDFL-CR(CG,GB,CW) for 48
MDF-LR88	Diffusion plate for directing lights	MDFL-CR(CG,GB,CW) for 88
MDF-LR100	Diffusion plate for directing lights	MDFL-CR(CG,GB,CW) for 100
MDF-LR1016	Diffusion plate for directing lights	MDFL-CR(CG,GB,CW) for 1016
MDF-DR7500	Diffusion plate for directing lights	MDFL-CR(CG,GB,CW) for 7500
MDF-DR13015	Diffusion plate for directing lights	MDFL-CR(CG,GB,CW) for 13015

An asterisk (*) in "compatible light models" refers to any LED color (R,G,B or W) of the light.

Polarizing plate:MPL Series

The MPL series polarizing plates are attached to LEDs to reduce unwanted glare and reflection during image processing.

Model	Product type	Compatible light models
MPL-DR09	Square oblique light polarizing plate	MDFL-CR(CG,GB,CW) for 10S_4 pieces/set
MPL-SC56	Simulated coaxial light polarizing plate	MDFL-CR(CG,GB,CW) for 56
MPL-SC74	Simulated coaxial light polarizing plate	MDFL-CR(CG,GB,CW) for 74
MPL-SC105	Simulated coaxial light polarizing plate	MDFL-CR(CG,GB,CW) for 105
MPL-DR16B	Polarizing plate for directing lights	MDFL-CR(CG,GB,CW) for 16
MPL-DR28B	Polarizing plate for directing lights	MDFL-CR(CG,GB,CW) for 28
MPL-DR31B	Polarizing plate for directing lights	MDFL-CR(CG,GB,CW) for 31
MPL-DR50B	Polarizing plate for directing lights	MDFL-CR(CG,GB,CW) for 50
MPL-DR56B	Polarizing plate for directing lights	MDFL-CR(CG,GB,CW) for 56
MPL-LR25B	Polarizing plate for directing lights	MDFL-CR(CG,GB,CW) for 25
MPL-LR48B	Polarizing plate for directing lights	MDFL-CR(CG,GB,CW) for 48
MPL-LR100B	Polarizing plate for directing lights	MDFL-CR(CG,GB,CW) for 100
MPL-LR1016B	Polarizing plate for directing lights	MDFL-CR(CG,GB,CW) for 1016
MPL-DR7500B	Polarizing plate for directing lights	MDFL-CR(CG,GB,CW) for 7500
MPL-DR13015B	Polarizing plate for directing lights	MDFL-CR(CG,GB,CW) for 13015

An asterisk (*) in "compatible light models" refers to any LED color (R,G,B or W) of the light.

Adapter : MAD Series

The MAD series is essential when a diffusion or polarizing plate is attached to a ring light.

Model	Product type	Compatible light models
MAD-DR10	Plate attachment adapter for directing lights	MDFL-CR(CG,GB,CW) for 10
MAD-DR16	Plate attachment adapter for directing lights	MDFL-CR(CG,GB,CW) for 16
MAD-DR28	Plate attachment adapter for directing lights	MDFL-CR(CG,GB,CW) for 28
MAD-DR31	Plate attachment adapter for directing lights	MDFL-CR(CG,GB,CW) for 31
MAD-DR50	Plate attachment adapter for directing lights	MDFL-CR(CG,GB,CW) for 50
MAD-DR56	Plate attachment adapter for directing lights	MDFL-CR(CG,GB,CW) for 56

An asterisk (*) in "compatible light models" refers to any LED color (R,G,B or W) of the light.

Light control film : MLM Series

The MLM series are resin films that transform diffused light into near-parallel light. Attached to a simulated coaxial light, it makes the light distribution pattern smoother.

Model	Product type	Compatible light models
MLM-SC56	Light control film for simulated coaxial lights	MDFL-CR(CG,GB,CW) for 56
MLM-SC74	Light control film for simulated coaxial lights	MDFL-CR(CG,GB,CW) for 74
MLM-SC105	Light control film for simulated coaxial lights	MDFL-CR(CG,GB,CW) for 105

An asterisk (*) in "compatible light models" refers to any LED color (R,G,B or W) of the light.

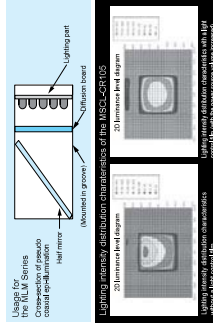
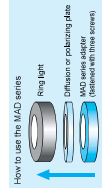

■ Options for bridging lights with lenses
The following optional adapters are designed to be used with Moritex's lenses.



Simulated Coaxial Light/CCTV Lens Adapter: MLA-SC Series

The MLA-SC Series enables small isolated coaxial lights to be mounted at the end of CCTV lenses.

Model	Product type	Compatible light models
MLA-SCB5	Mount base for simulated coaxial lights	MSCL-C24/30/35
MLA-SCM25	Base/lens adapter for simulated coaxial lights	M25.5 P0.5 lens
MLA-SCM70	Base/lens adapter for simulated coaxial lights	M27 P0.5 lens
MLA-SCM05	Base/lens adapter for simulated coaxial lights	M30.5 P0.5 lens

An asterisk (*) in "compatible light models" refers to any LED color (R,G,B or W) of the light.

*Do not apply any unnecessary load to the lens.

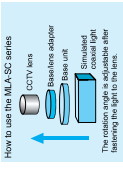

MML/CCTV Lens Adapter

The adapter can be easily used in combination with Moritex's lenses.

Model	Product type	Compatible light models
MLA-DR1616	Lens attachment adapter	MDR-C*16 and R-16 mm lenses
MLA-DR1725	Lens attachment adapter	MDR-C*17 and R-25 mm lenses
MLA-DR1730	Lens attachment adapter	MDR-C*17 and R-30 mm lenses
MLA-DR1M255	Lens attachment adapter	MDR-C*17 and M25.5 P0.5 lenses
MLA-DR1M270	Lens attachment adapter	MDR-C*17 and M27 P0.5 lenses
MLA-DR1M305	Lens attachment adapter	MDR-C*17 and M30.5 P0.5 lenses

An asterisk (*) in "compatible light models" refers to any LED color (R,G,B or W) of the light.

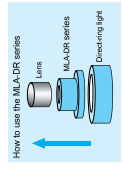

Sharp-cut Filter R64 Series

These Filters can be attached to the end of a CCTV lens to prevent light interference when using red light.

Model	Product type	Size
ML-R64-25	Sharp-cut filter for mounting to end of lens	M25.5 P0.5 lens
ML-R64-27	Sharp-cut filter for mounting to end of lens	M27 P0.5 lens
ML-R64-30	Sharp-cut filter for mounting to end of lens	M30.5 P0.5 lens

Cables

Model	Cable Diagram	Product type	Applications	Length
M-RCE401L	A	4.2cm type extension cable	• For all lights (except the MCEP series)	1m
M-RCE402L	A	4.2cm type extension cable		2m
M-RCE403L	A	4.2cm type extension cable		3m
M-RCE301L	B	3.2cm type extension cable	• For the MCEP series	1m
M-RCE302L	B	3.2cm type extension cable		2m
M-RCE303L	B	3.2cm type extension cable		3m
M-SS400C	C	Phi type extension cable	• For the MSPP series	2m
M-SS405C	C	Phi type extension cable		5m
M-SS410C	C	Phi type extension cable		10m
M-RCE301XS	D	Phi type M5PM-ER-A070 conversion cable	• For the MSPP series and MLEP-A070	1m
M-RCE301L	E	2.2cm type extension cable		1m
M-RCE302L	E	2.2cm type extension cable		2m
M-RCE303L	E	2.2cm type extension cable	• For power sources for built-in lens	3m
MC-EXC-02	—	Cable for DSUB15 pin external control		—
MC-EXC-07	—	Cable for DSUB15 pin external control	—	—

Cable Diagrams

