

UG485: Class 3 Isolated Flyback Evaluation Board for the Si3404

The Si3404 isolated flyback evaluation board is a reference design for a power supply in a Power over Ethernet (PoE) Powered Device (PD) application.

This Si3404-ISO-FB EVB provides simple and low-cost solution with different output voltages and power levels.

The Si3404-ISO-FB EVB board is shown below. The Si3404 IC integrates an IEEE 802.3af compatible PoE interface as well as a current control-based dc/dc converter.

The Si3404 PD integrates a detection circuit, classification circuit, dc/dc switch, hotswap switch, TVS overvoltage protection, dynamic soft-start circuit, cycle-by-cycle current limit, thermal shutdown, and inrush current protection.

The switching frequency is set to 220 kHz by installing R14 = 88.7 kΩ.

KEY FEATURES

- IEEE 802.3af compliant
- Very small application PCB surface
- High efficiency
- High integration
- Low-profile 4 x 4 mm 20-pin QFN
- Integrated thermal shutdown protection
- Low BOM Cost
- Integrated transient overvoltage protection
- Equipped with off-the-shelf transformers

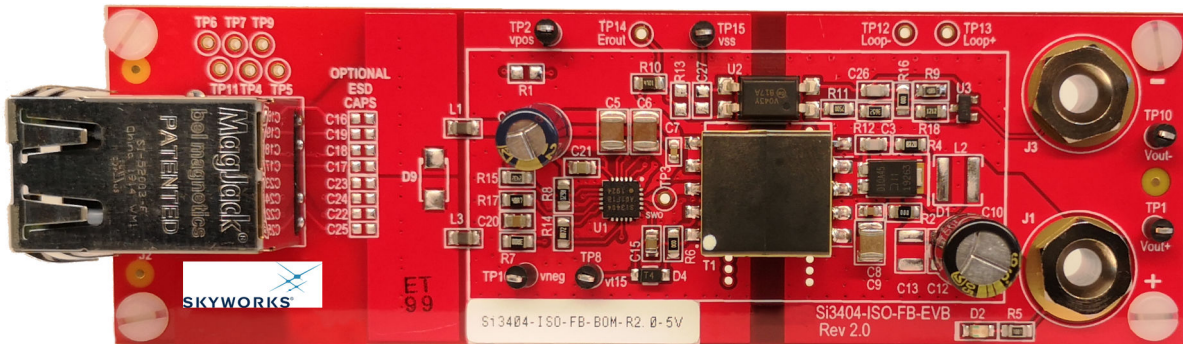

Parameter	Condition	Specifications		
Ordering Part Number	—	Si3404FB3V3KIT	Si3404FB5V3KIT	Si3404FB12V3KIT
PSE input voltage range	Connector J2	37 V to 57 V		
PoE Type/Class	IEEE 802.3af	Type 1/Class 3		
Output Voltage / Current	Connectors J1–J3	3.3 V / 3.5 A	5 V / 2.5 A	12 V / 1 A
Peak Efficiency, End-to-End	$V_{IN} = 50$ V, Schottky Bridge	80.68 %	83.11 %	85.27 %
Peak Efficiency, End-to-End	$V_{IN} = 50$ V, Silicon Bridge	80.13 %	82.60 %	84.71 %
Switching frequency	$R_{FREQ} (R14) = 88.7$ kΩ	220 kHz		
Conducted EMI	EN55032, average detector	Passed		
Conducted EMI	EN55032, peak detector	Passed		
Radiated EMI	EN55032 Class B	Passed		

Table of Contents

1. Selector Guide	4
2. Powering Up the Si3404-ISO-FB Board	5
3. Si3404-ISO-FB EVB: 3.3 V, Class 3 Configuration	6
3.1 Si3404-ISO-FB EVB Schematic: 3.3 V, Class 3, 15.4 W	6
3.2 End-to-End EVB Efficiency	7
3.3 Thermal Measurements	8
3.4 Sifos PoE Compatibility Test Results	8
3.5 Adjustable EVB Current Limit	9
3.6 Feedback Loop Phase and Gain Measurement Results (Bode Plots)	10
3.7 Load Step Transient Measurement Results	11
3.8 Output Voltage Ripple	12
3.9 Soft-Start Protection	12
3.10 Output Short Protection	13
3.11 Pulse Skipping at No-Load Condition	14
3.12 Discontinuous (DCM) and Continuous (CCM) Conduction Modes	15
3.13 Radiated Emissions Measurement Results	16
3.14 Conducted Emissions Measurement Results	17
3.15 Bill of Materials	18
4. Si3404-ISO-FB EVB: 5 V, Class 3 Configuration	21
4.1 Si3404-ISO-FB EVB Schematic: 5 V, Class 3, 15.4 W	21
4.2 End-to-End EVB Efficiency	22
4.3 Thermal Measurements	23
4.4 Sifos PoE Compatibility Test Results	23
4.5 Adjustable EVB Current Limit	24
4.6 Feedback Loop Phase and Gain Measurement Results (Bode Plots)	25
4.7 Load Step Transient Measurement Results	26
4.8 Output Voltage Ripple	27
4.9 Soft-Start Protection	27
4.10 Output Short Protection	28
4.11 Pulse Skipping at No-Load Condition	29
4.12 Discontinuous (DCM) and Continuous (CCM) Conduction Modes	30
4.13 Radiated Emissions Measurement Results	31
4.14 Conducted Emissions Measurement Results	32
4.15 Bill of Materials	33
5. Si3404-ISO-FB EVB: 12 V, Class 3 Configuration	36

5.1 Si3404-ISO-FB EVB Schematic: 12 V Class 3, 15.4W36
5.2 End-to-End EVB Efficiency37
5.3 Thermal Measurements38
5.4 Sifos PoE Compatibility Test Results38
5.5 Adjustable EVB Current Limit39
5.6 Feedback Loop Phase and Gain Measurement Results (Bode Plots).40
5.7 Load Step Transient Measurement Results41
5.8 Output Voltage Ripple42
5.9 Soft-Start Protection42
5.10 Output Short Protection43
5.11 Pulse Skipping at No-Load Condition44
5.12 Discontinuous (DCM) and Continuous (CCM) Conduction Modes45
5.13 Radiated Emissions Measurement Results46
5.14 Conducted Emissions Measurement Results47
5.15 Bill of Materials48
6. Tunable Switching Frequency	51
7. Board Layout	52
8. Design and Layout Checklist	54
9. Complete 3.3 V Si3404 Isolated Flyback Sifos Compatibility Test Reports.	55
10. Complete 5 V Si3404 Isolated Flyback Sifos Compatibility Test Reports	63
11. Complete 12 V Si3404 Isolated Flyback Sifos Compatibility Test Reports	71

1. Selector Guide

The output voltage of this isolated flyback evaluation board depends mainly on the turns ratio of the flyback transformer, with the adequate transformer it's possible to generate any kind of output voltage.

This user guide presents configurations for three different output voltages: 3.3 V, 5 V, and 12 V.

The efficiency of the EVB highly depends on the output voltage. Higher output voltage configurations tend to have higher efficiency, meanwhile, lower output voltage configurations have lower efficiency.

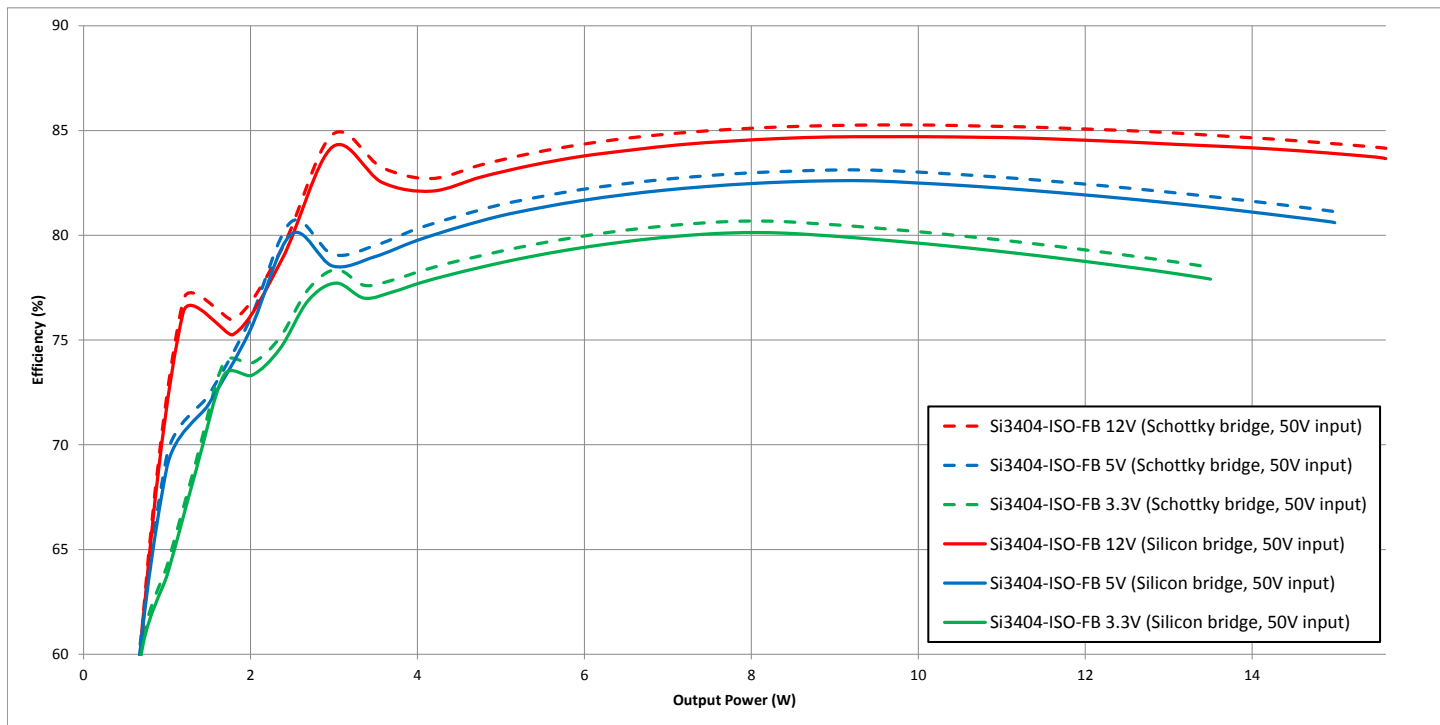

Figure 1.1. Si3404-ISO-FB EVB's End-to-End Efficiency of Different Configurations: 50 V Input

Note:

The chart shows the end-to-end EVB efficiency, where voltage drop on the diode bridge is included and LEDs are removed.

The standard Si3404-ISO-FB EVB is shown on the cover page. This document includes complete schematics and measurement data for the three different output voltages below:

- Si3404-ISO-FB-3.3V-15.4W – Class 3
- Si3404-ISO-FB-5.0V-15.4W – Class 3
- Si3404-ISO-FB-12V-15.4W – Class 3

The parts in red on the schematics represent the BOM differences between the three designs.

The boards are shipped with silicon type diode bridges installed. If higher efficiency is needed, those S1B diodes can be replaced with Schottky types, such as SS2150 parts. See Figure 1.1 for overall conversion efficiency results.

When Schottky bridge is used, to compensate the reverse leakage of the Schottky type diode bridges at high temperature, the recommended detection resistor should be adjusted to the values listed in the following table:

Table 1.1. Recommended Detection Resistor Values

External Diode Bridge	R _{DET}
Silicon Type	24.3 kΩ
Schottky Type	24.9 kΩ

2. Powering Up the Si3404-ISO-FB Board

Ethernet data and power are applied to the board through the RJ45 connector (J2). The board itself has no Ethernet data transmission functionality, but, as a convenience, the Ethernet with secondary-side data is brought out to test points.

The design can be used in Gigabit (10/100/1000) systems as well by using PoE RJ45 Magjack, such as type L8BE-1G1T-BFH from Bel Fuse.

Power may be applied in the following ways:

- Using any IEEE 802.3-2015-compliant, PoE-capable PSE, or
- Using a laboratory power supply unit (PSU):
 - Connecting a dc source between blue/white-blue and brown/white-brown of the Ethernet cable (either polarity), (End-span) as shown below:

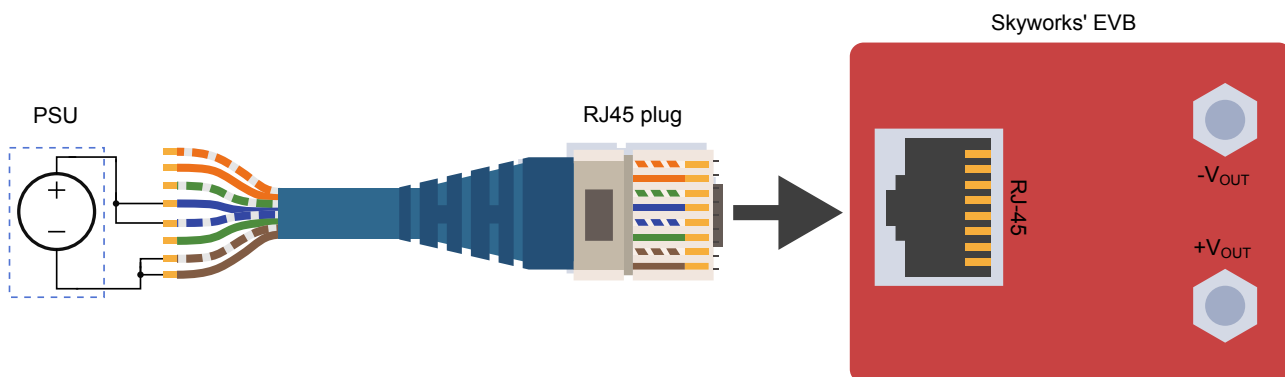

Figure 2.1. Endspan Connection using Laboratory Power Supply

- Connecting a dc source between green/white-green and orange/white-orange of the Ethernet cable (either polarity), (Mid-span) as shown below:

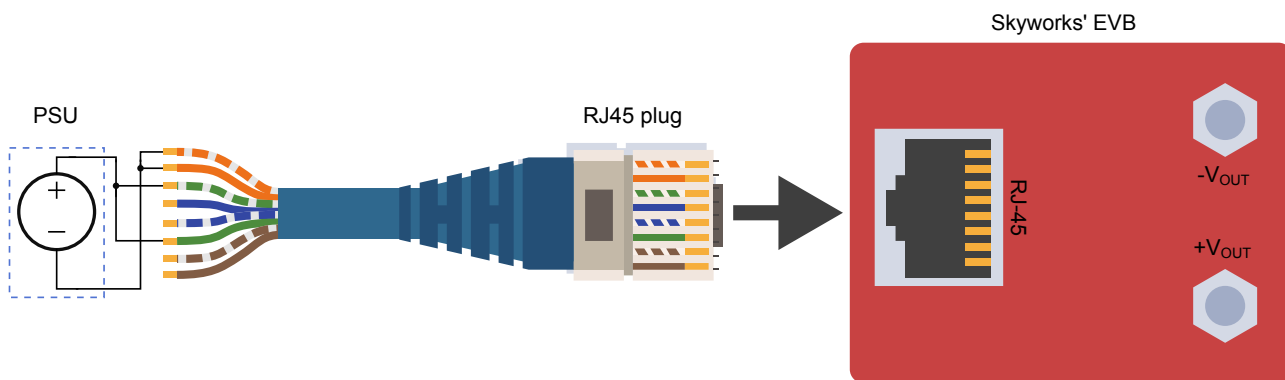
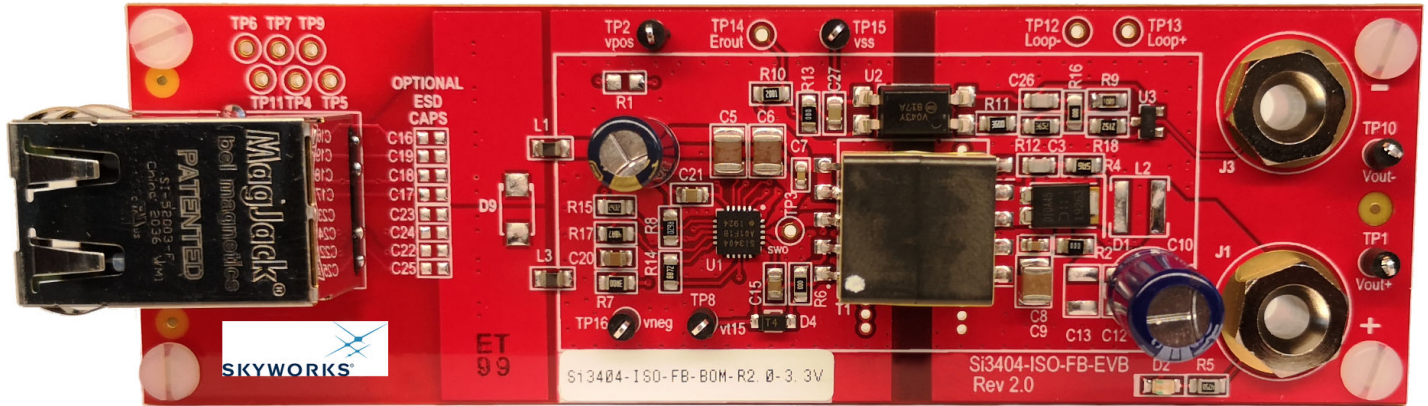

Figure 2.2. Midspan Connection using Laboratory Power Supply

3. Si3404-ISO-FB EVB: 3.3 V, Class 3 Configuration



3.1 Si3404-ISO-FB EVB Schematic: 3.3 V, Class 3, 15.4 W

The figure below shows the schematic of the Si3404-ISO-FB 3.3 V, Class 3 EVB. The parts in red in the schematic represent the BOM differences compared to the other output voltage variants of this EVB. The parts in gray are not installed on the EVB, but they have footprints.

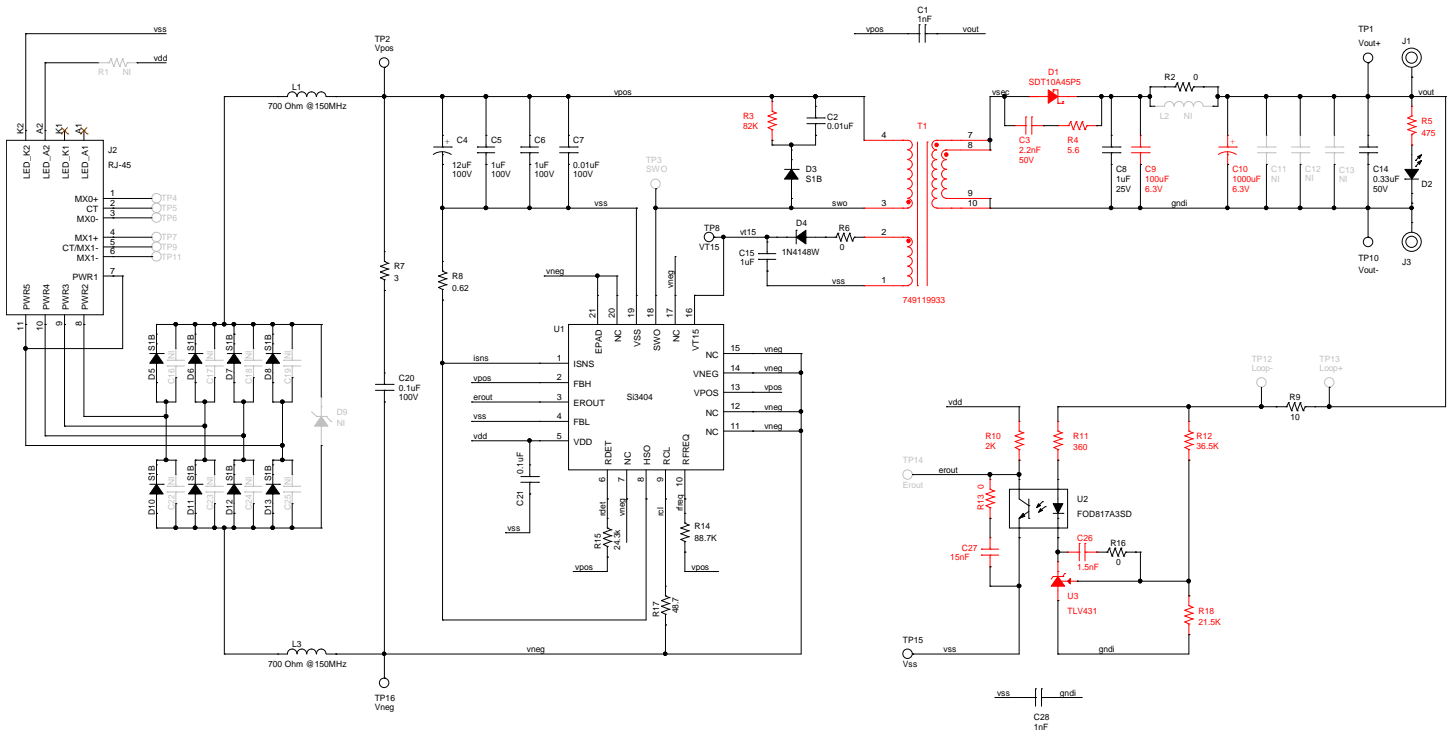

Figure 3.1. Si3404-ISO-FB EVB Schematic: 3.3 V, Class 3 PD, 15.4 W

3.2 End-to-End EVB Efficiency

The end-to-end efficiency measurement data of the Si3404-ISO-FB 3.3V EVB is shown in the figures below. Efficiency was measured from PoE (RJ45 connector) input to the 3.3 V output. The efficiency was measured at three different input voltage levels, 39.9 V, 50 V and 57 V, with two input diode bridge configurations: silicon (S1B) and Schottky (SS2150).

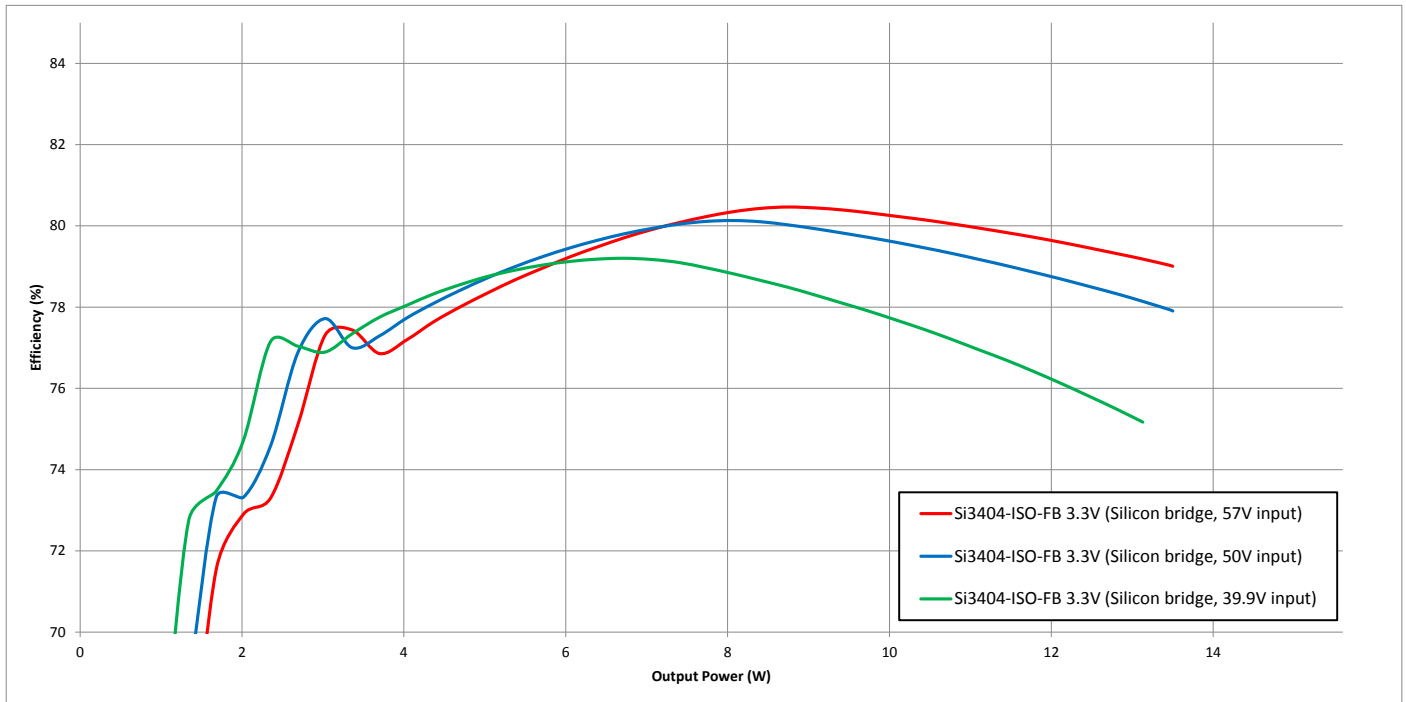

Figure 3.2. Si3404-ISO-FB End-to-End Efficiency Chart with Silicon Type Input Bridge Diodes: Multiple Input Voltages, 3.3 V Output, Class 3

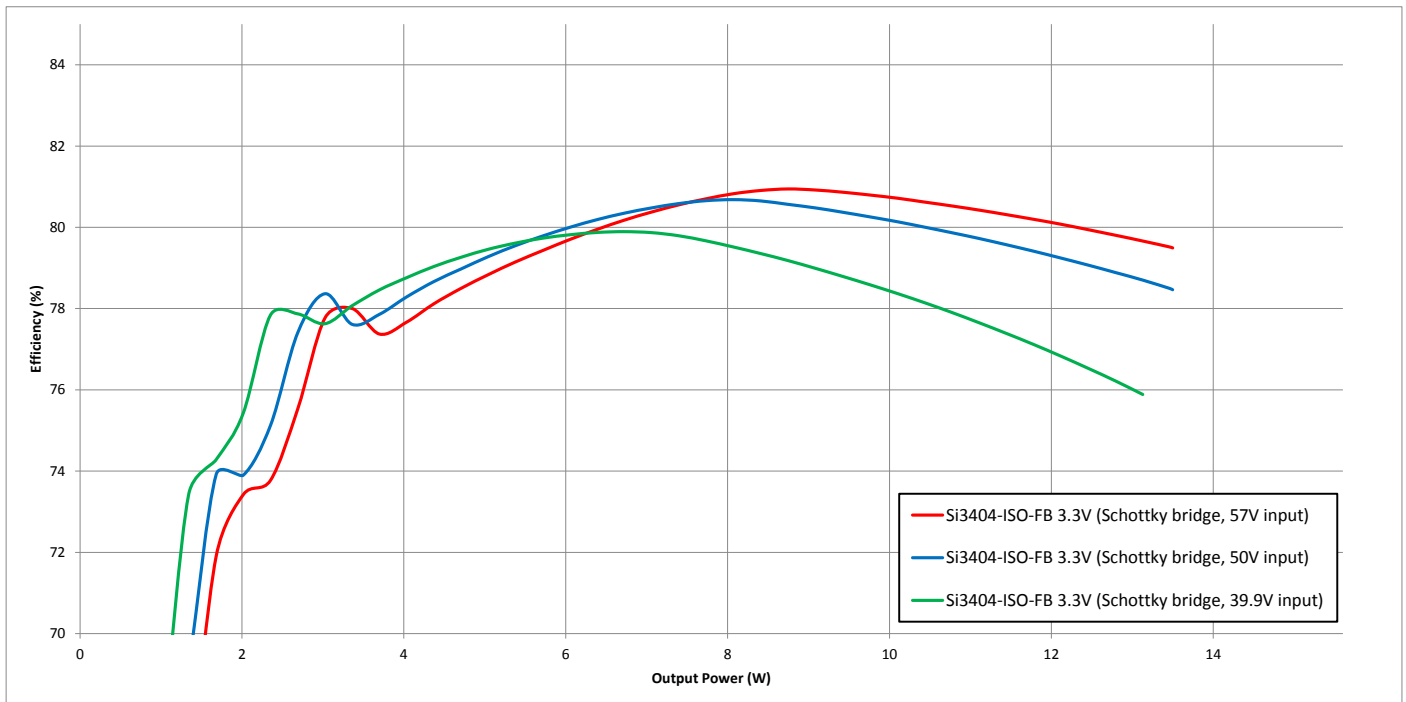

Figure 3.3. Si3404-ISO-FB End-to-End Efficiency Chart with Schottky Type Input Bridge Diodes: Multiple Input Voltages, 3.3 V Output, Class 3

Note: The charts show end-to-end EVB efficiency. The voltage drop of the diode bridge is included. The onboard LEDs are disabled.

3.3 Thermal Measurements

The Si3404-ISO-FB EVB's temperature was measured at maximum **input power – 13 W**. The Si3404-ISO-FB EVB is configured for 3.3 V output voltage and Class 3 power level. The following figure shows thermal images taken of the EVB board at maximum input power.

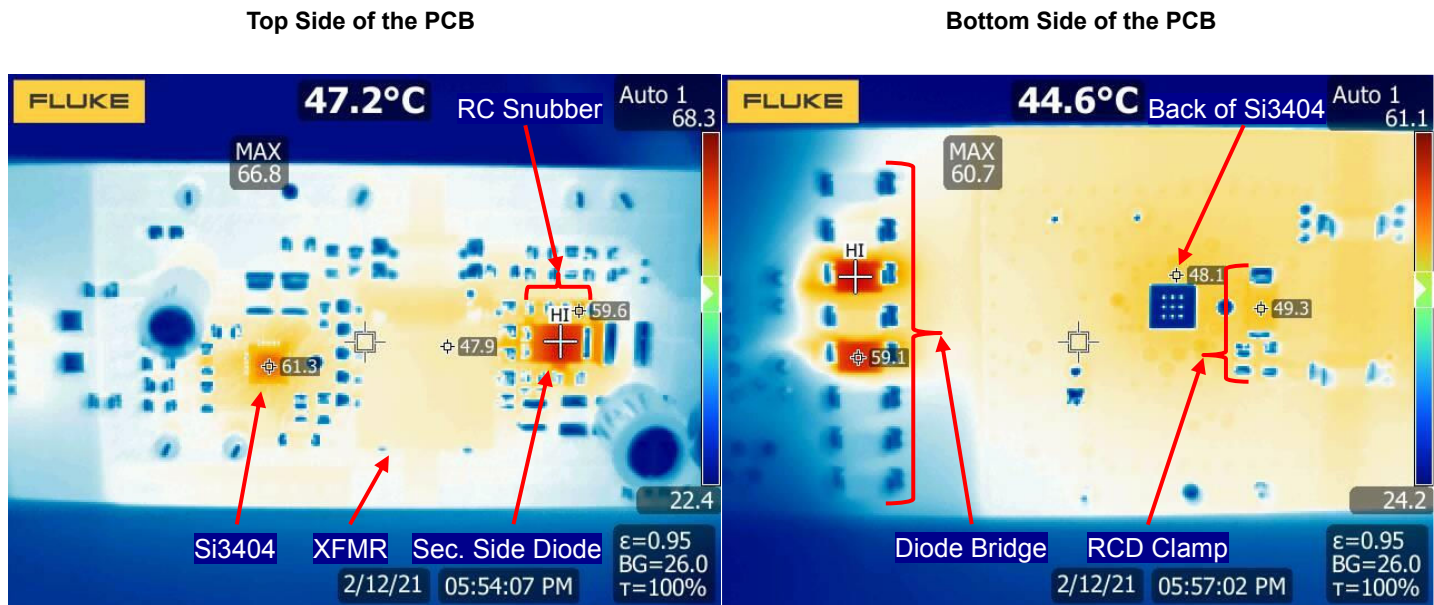

Figure 3.4. Thermal Measurements of the Si3404-ISO-FB EVB, 3.3 V, Class 3 PD

The following table lists the temperatures of the notable components across the board:

Table 3.1. Component Temperatures at Full Load

Component	Temperature ¹
Si3404 – U1	61.3 °C
Flyback Transformer – T1	47.9 °C
Secondary Side Diode – D1	66.8 °C
Secondary Side RC Snubber – C3-R4	59.6 °C
Diode Bridge – D5-D8, D10-D13	60.7 °C
Primary Side RCD Clamp – R3-C2-D3	49.3 °C
Note:	
1. The ambient temperature was 26 °C during the thermal measurements.	

3.4 Sifos PoE Compatibility Test Results

The PDA-604A Powered Device Analyzer is a single-box comprehensive solution for testing IEEE 802.3at and IEEE 802.3bt PoE Powered Devices (PDs). The Si3404-ISO-FB 3.3 V EVB board has been successfully tested with the PDA-604A Powered Device Analyzer from Sifos Technologies.

Unlike the Si3406x family, the Si3404 does not incorporate the MPS feature. To prevent PSE shutdown, a minimal 10R load was applied to the Si3404-ISO-FB 3.3 V EVB's output during the Sifos tests.

See [9. Complete 3.3 V Si3404 Isolated Flyback Sifos Compatibility Test Reports](#) for more information.

3.5 Adjustable EVB Current Limit

For additional safety, the Si3404 has an adjustable EVB current limit feature.

The Si3404 controller measures the voltage on the R_{SENSE} resistor (R8) through the ISNS pin. Care must be taken that this voltage goes below V_{SS} . When the voltage on R8 is $V_{ISNS} = -270$ mV (referenced to V_{SS}), the internal current limit circuit restarts the PD to protect the application.

The EVB current limit for this Class 3 application can be calculated with the following formula:

$$R_{SENSE} = 0.62\Omega$$

$$I_{LIMIT} = \frac{270mV}{0.62\Omega} = 435mA$$

Equation 3.1. EVB Class 3 Current Limit

3.6 Feedback Loop Phase and Gain Measurement Results (Bode Plots)

The Si3404 device integrates a current-mode-controlled switching mode power supply controller circuit. Therefore, the application is a closed-loop system. To guarantee stable output voltage of the power supply and to reduce the influence of the input voltage variations and load changes on the output voltage, the feedback loop should be stable.

To verify the stability of the loop, the gain and phase of the loop has been measured.

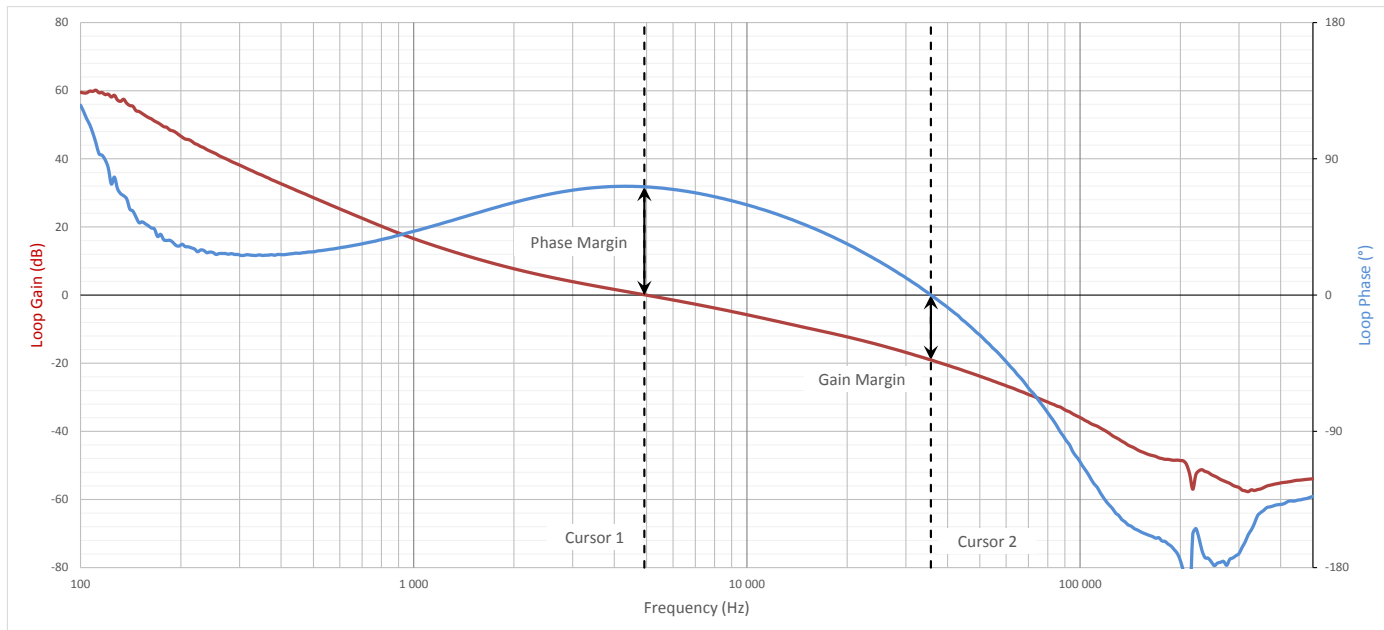

Figure 3.5. Si3404-ISO-FB EVB, 3.3 V, Class 3 PD Feedback Loop Measurement Results at Light Load

Table 3.2. Measured Loop Gain and Phase Margin at Light Load

	Frequency	Gain	Phase
Cursor 1 (Phase Margin)	4.98 kHz	0 dB	71.46 °
Cursor 2 (Gain Margin)	35.68 kHz	-19.05 dB	0 °

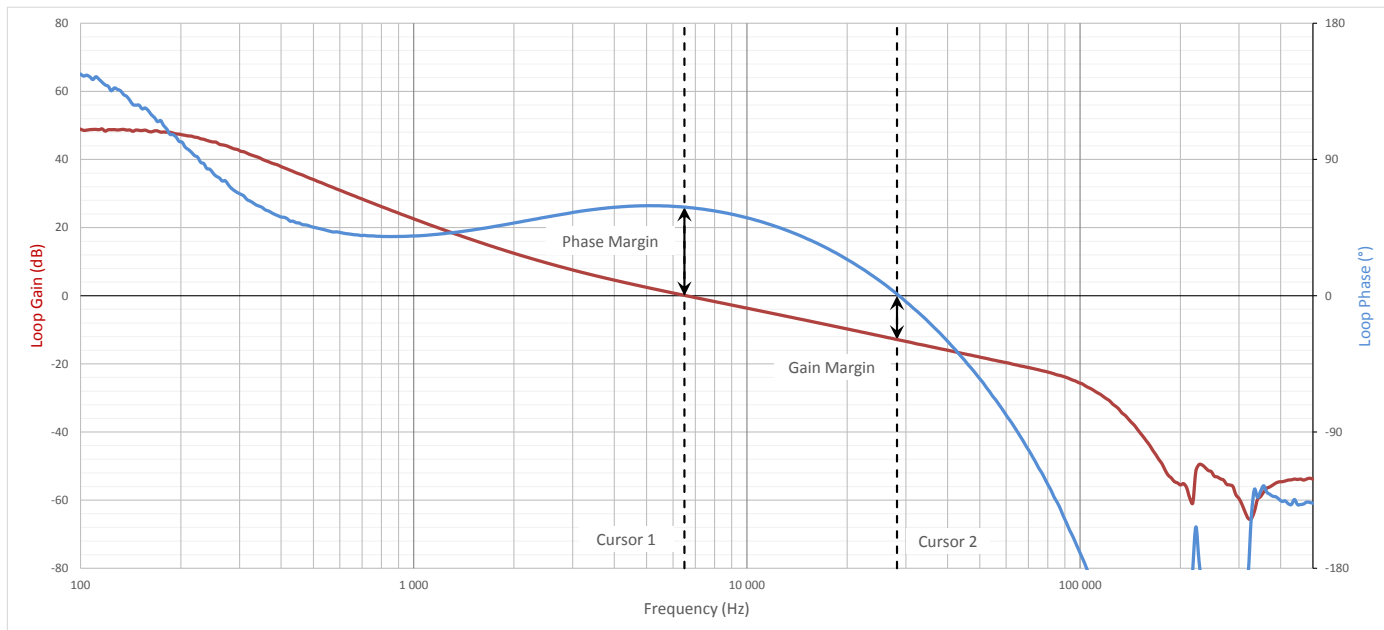

Figure 3.6. Si3404-ISO-FB EVB, 3.3 V, Class 3 PD Feedback Loop Measurement Results at Full Load

Table 3.3. Measured Loop Gain and Phase Margin at Full Load

	Frequency	Gain	Phase
Cursor 1 (Phase Margin)	6.58 kHz	0 dB	58.44 °
Cursor 2 (Gain Margin)	28.62 kHz	-12.98 dB	0 °

The following table sums up the circumstances of the feedback loop measurements.

Table 3.4. Feedback Loop Measurements Circumstances

Measurement Name	Input Voltage	Output Load
Feedback Loop Measurement at Light Load	50 V	10 R
Feedback Loop Measurement at Full Load	50 V	0.9375 R

3.7 Load Step Transient Measurement Results

The output of the Si3404-ISO-FB EVB board has been tested with a load step function to verify the converter's output dynamic response.

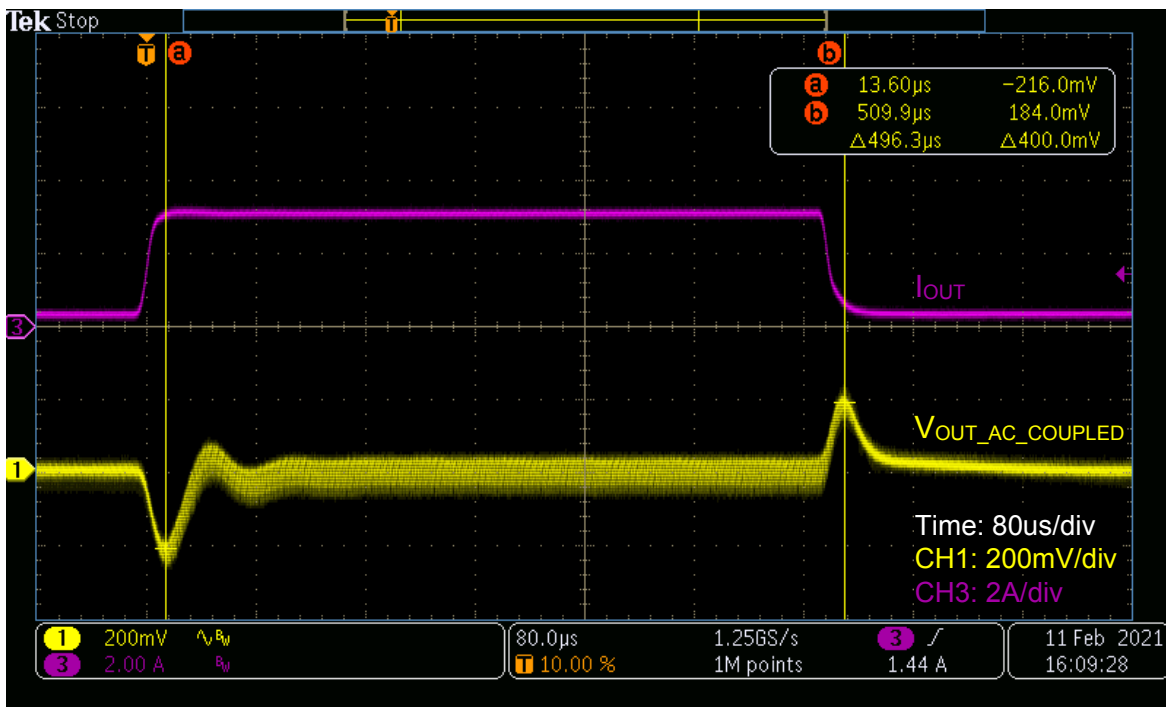

Figure 3.7. Si3404-ISO-FB EVB, 3.3 V, Class 3 PD Output Load Step Transient Test

The following table sums up the results of the load step measurement.

Table 3.5. Output Load Step Transient Results

	From (Output Current)	To (Output Current)	Slew Rate (Output Current)	V _{OUT} Change
Stepping up the load	0.35 A	3.15 A	2500 mA/μs	3.3 V – 216 mV
Stepping down the load	3.15 A	0.35 A	2500 mA/μs	3.3 V +184 mV

3.8 Output Voltage Ripple

The Si3404-ISO-FB EVB output voltage ripple has been measured under both No-Load and Heavy-Load conditions.

No-Load V_{OUT} Ripple = 13.4 mV

Heavy-Load V_{OUT} Ripple = 91 mV

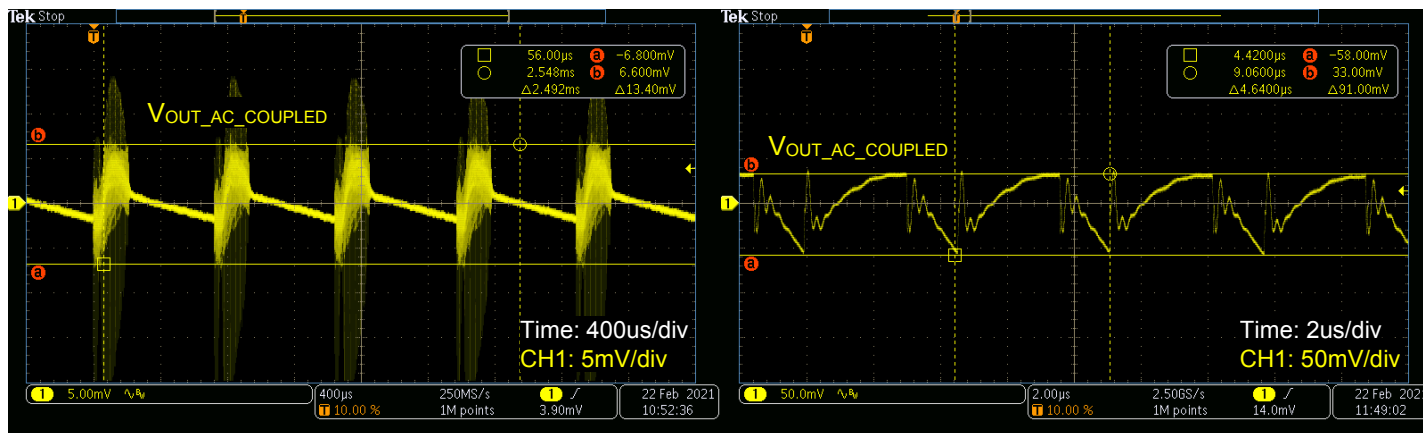

Figure 3.8. Si3404-ISO-FB EVB, 3.3 V, Class 3 Output Voltage Ripple No Load (Left) and Heavy Load (Right) Conditions

3.9 Soft-Start Protection

The Si3404 device has an integrated dynamic soft-start protection mechanism to avoid stressing the components by the sudden current or voltage changes associated with the initial charging of the output capacitors.

The Si3404 intelligent adaptive soft-start mechanism does not require any external component to install. The controller continuously measures the input current of the PD and dynamically adjusts the internal I_{PEAK} limit during soft-start, thus adjusting the output voltage ramp-up time as a function of the attached load.

The controller allows the output voltage to rise faster in no load (or light load) conditions. With a heavy load at the output, the controller slows down the output voltage ramp to avoid exceeding the desired regulated output voltage value.

No-Load Soft-Start $t_{RISE} = 5.1$ ms

Heavy-Load Soft-Start $t_{RISE} = 36.8$ ms

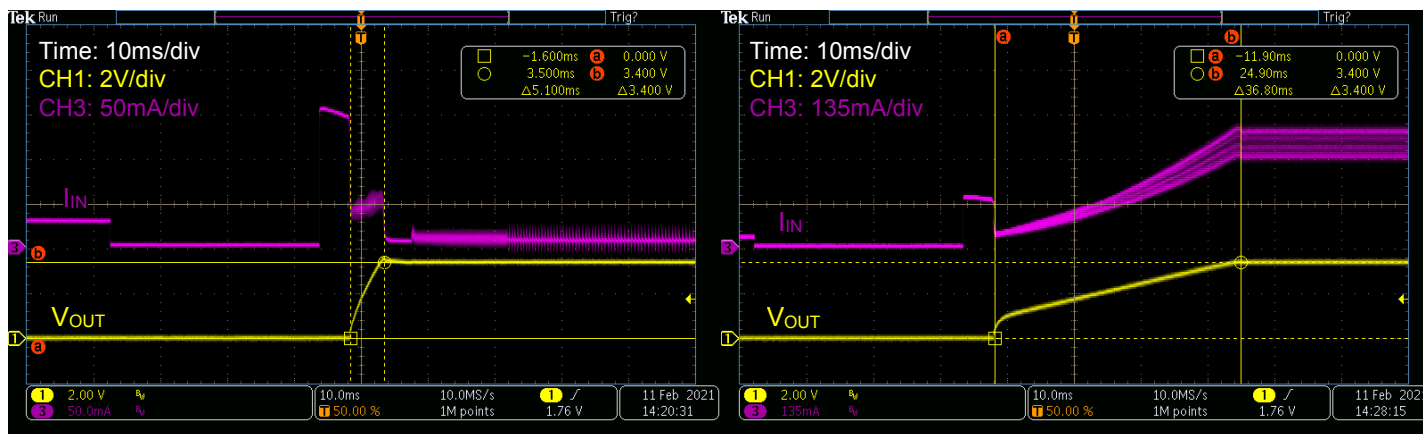

Figure 3.9. Si3404-ISO-FB EVB, 3.3 V, Class 3 Output Voltage Soft-Start at Low Load (Left) and Heavy Load (Right) Conditions

3.10 Output Short Protection

The Si3404 has an integrated output short protection mechanism, which protects the IC and surrounding external components from overheating in case of an electrical short on the output.

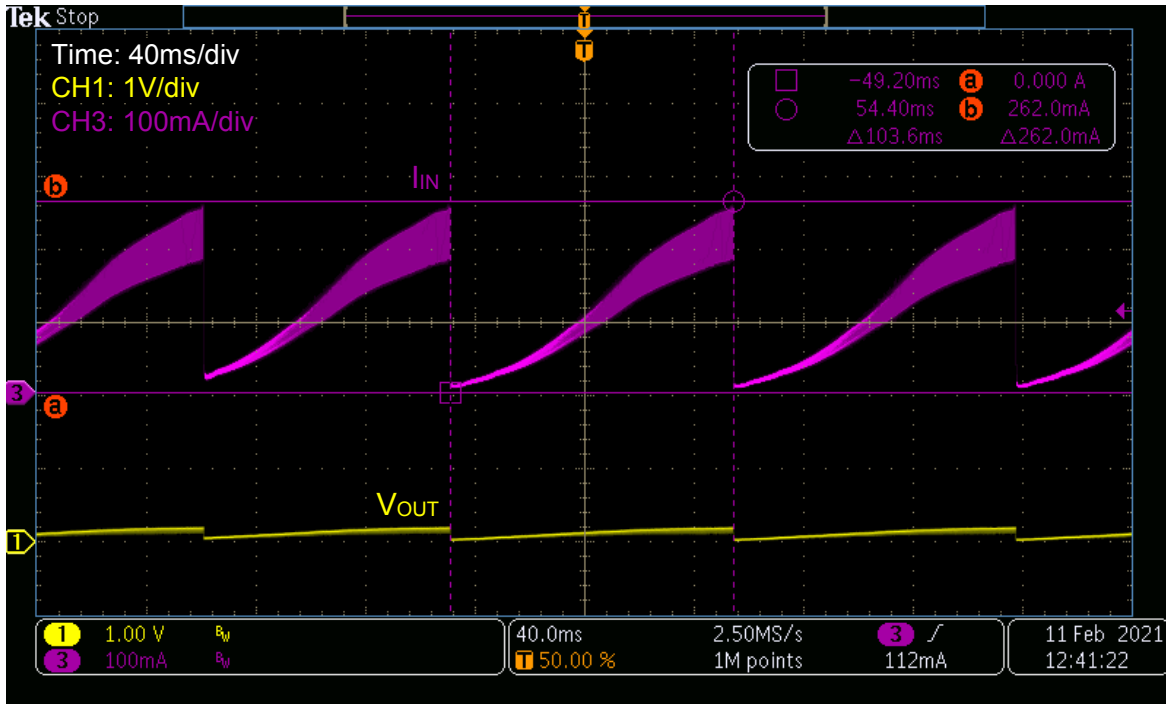

Figure 3.10. Si3404-ISO-FB EVB, 3.3 V, Class 3 Output Short Circuit Protection

3.11 Pulse Skipping at No-Load Condition

The Si3404 device has an integrated pulse skipping mechanism to ensure ultra-low power consumption under light load conditions.

As the output load decreases, the controller starts to reduce the pulse-width of the PWM signal (switcher ON time). At some point, even the minimum width pulse will provide higher energy than the application requires, which could result in a loss of voltage regulation.

When the controller detects a light load condition (which requires less ON time than the minimum pulse width), the controller enters into pulse-skipping mode. This mode is shown in the following figure, which depicts the switching node of the integrated switching FET at a no-load condition.

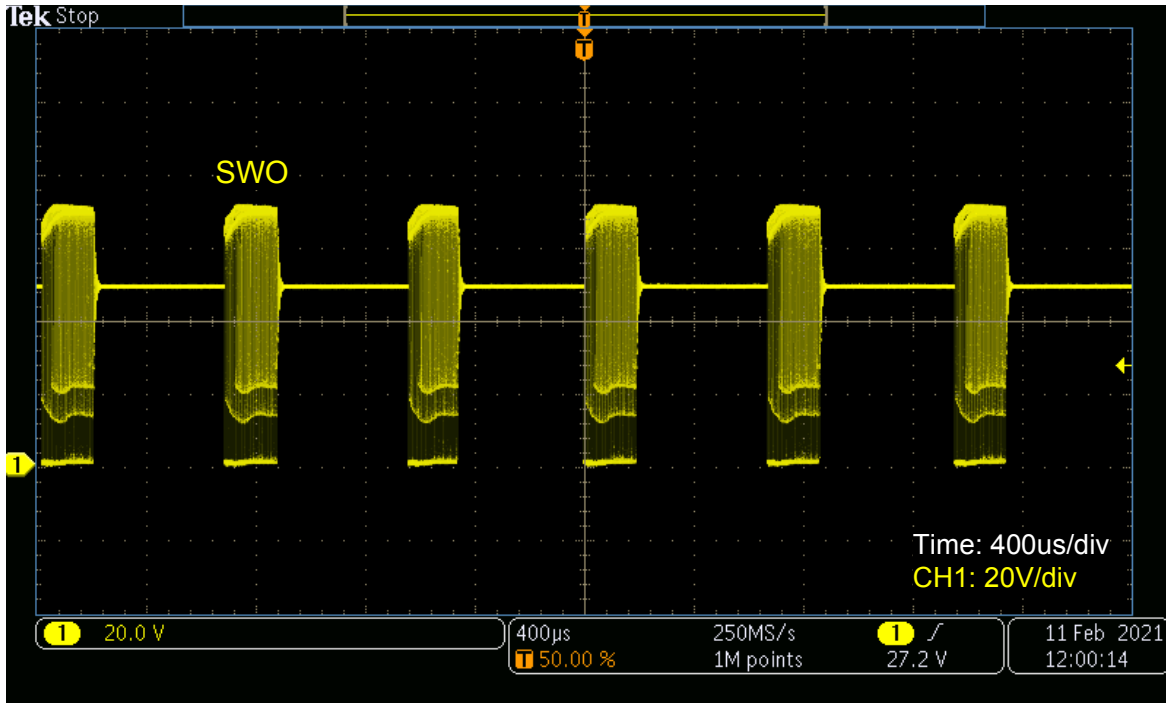

Figure 3.11. Si3404-ISO-FB EVB, 3.3 V, Class 3 Pulse Skipping at No-load Condition: SWO Waveform

3.12 Discontinuous (DCM) and Continuous (CCM) Conduction Modes

At low load, the converter works in discontinuous conduction mode (DCM). At heavy load, the converter runs in continuous conduction mode (CCM). At low load, the SWO voltage waveform has a ringing waveform, which is typical for DCM operation.

Low-Load, DCM

Heavy-Load, CCM

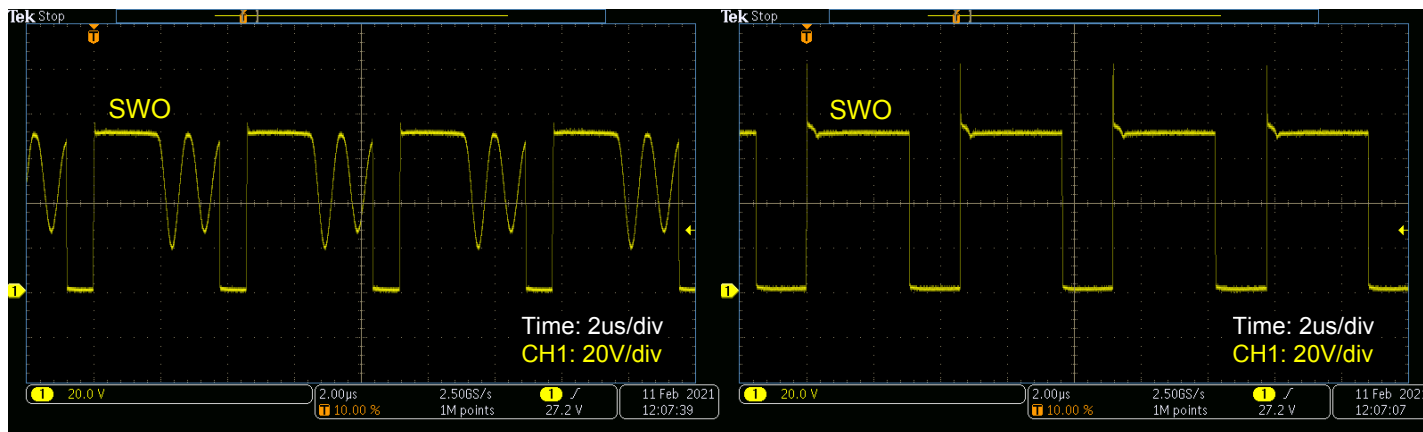

Figure 3.12. Si3404-ISO-FB EVB, 3.3 V, Class 3: SWO Waveform in Discontinuous Conduction Mode (DCM) at Low Load (Left), and in Continuous Conduction Mode (CCM) at Heavy Load (Right)

Similar voltage waveforms can be observed on the secondary side diode, D1. The voltage levels on the secondary side diode, D1, are much lower due to the transformer turns ratio; however, the discontinuous and continuous conduction mode characteristics are still present.

Low-Load, DCM

Heavy-Load, CCM

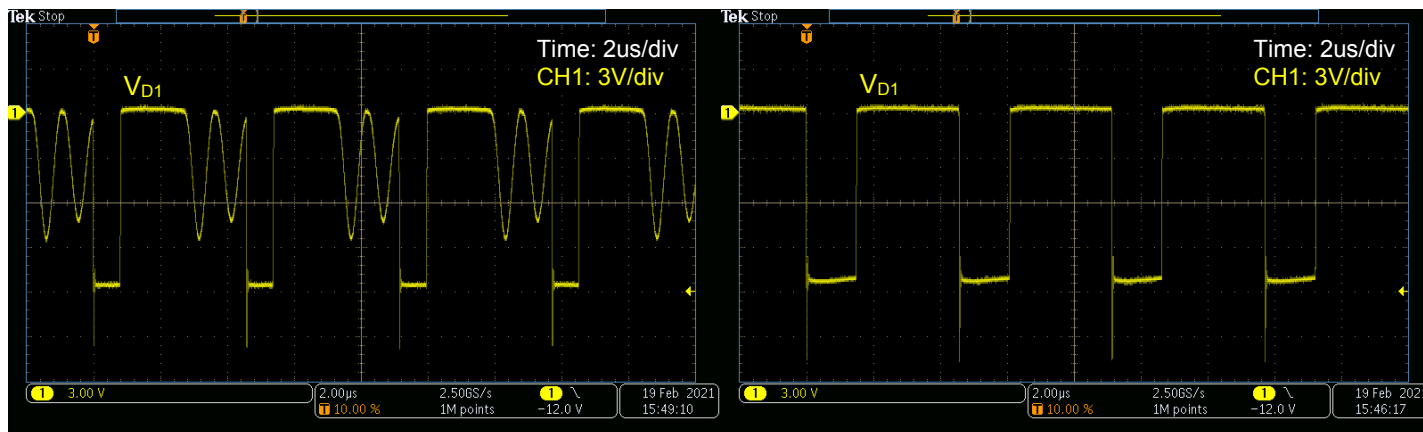

Figure 3.13. Si3404-ISO-FB EVB, 3.3 V, Class 3: Secondary Side Diode Voltage Waveform in Discontinuous Conduction Mode (DCM) at Low Load (Left), and in Continuous Conduction Mode (CCM) at Heavy Load (Right)

3.13 Radiated Emissions Measurement Results

Radiated emissions of the Si3404-ISO-FB, 3.3 V, Class 3 EVB board have been measured with 50 V input voltage and a full load connected to the output. The input power was 15 W in this case.

As shown below, the Si3404-ISO-FB, 3.3 V, Class 3 EVB is fully compliant with the international EN 55032 Class B emissions standard.

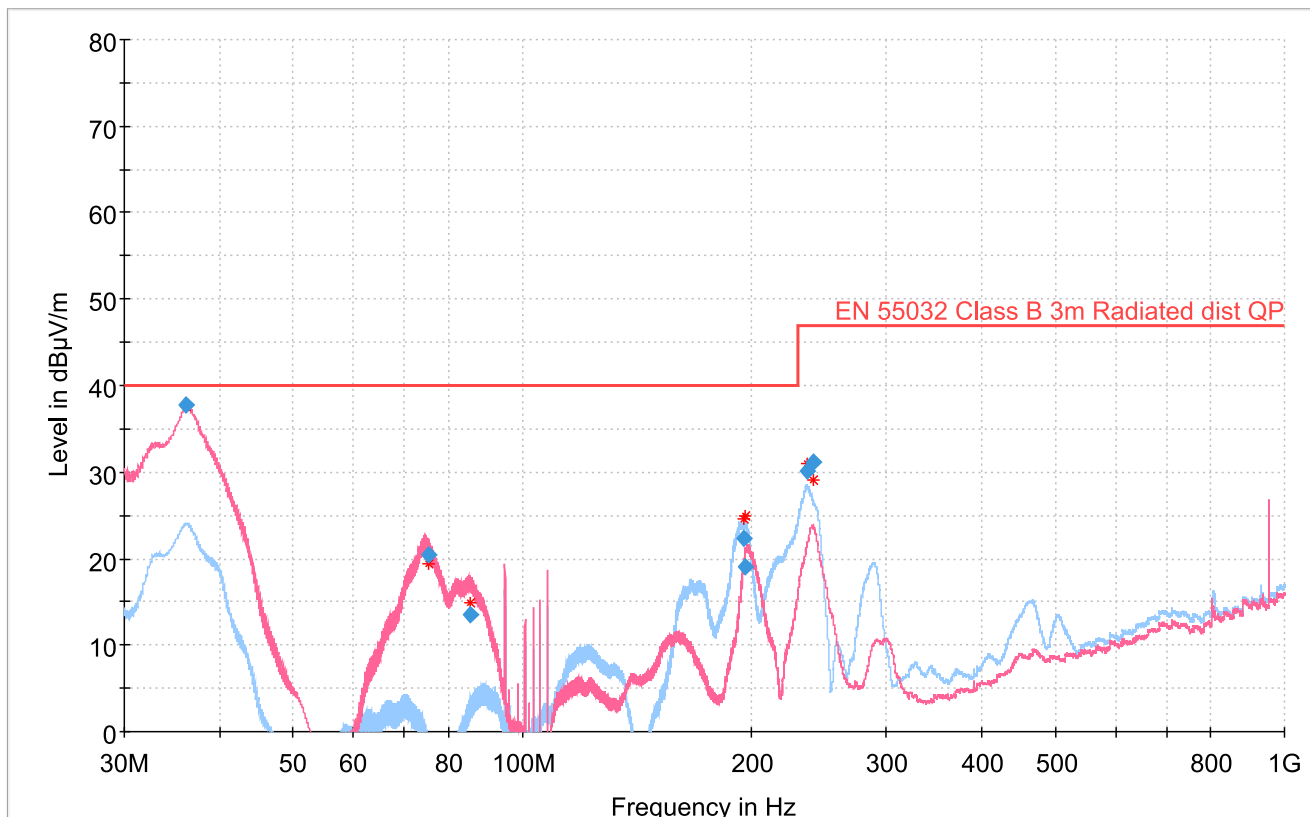

Figure 3.14. Si3404-ISO-FB EVB Radiated Emissions Measurements Results; 50 V Input, 3.3 V Output, 15 W Input Power

Table 3.6. Notable Peaks on The Radiated Emissions Chart

Frequency	Quasi Peak	Limit	Margin	Polarization
36.12 MHz	37.83 dBµV/m	40 dBµV/m	2.17 dB	Vertical
75.15 MHz	20.49 dBµV/m	40 dBµV/m	19.51 dB	Vertical
85.26 MHz	13.57 dBµV/m	40 dBµV/m	26.43 dB	Vertical
195.00 MHz	22.31 dBµV/m	40 dBµV/m	17.69 dB	Horizontal
196.35 MHz	19.04 dBµV/m	40 dBµV/m	20.96 dB	Vertical
235.77 MHz	30.10 dBµV/m	47 dBµV/m	16.90 dB	Horizontal
241.23 MHz	31.24 dBµV/m	47 dBµV/m	15.76 dB	Horizontal

The EVB is measured at full load with peak detection in both vertical and horizontal polarizations. This is a relatively fast process that produces a red curve (vertical polarization) and a blue curve (horizontal polarization).

Next, specific frequencies are selected (red stars) for quasi-peak measurements. The board is measured again at those specific frequencies with a quasi-peak detector, which is a very slow but accurate measurement. The results of this quasi-peak detector measurement are the blue rhombuses.

The blue rhombuses represent the final result of the measurement process. To have passing results, the blue rhombuses should be below the highlighted EN 55032 Class B limit.

3.14 Conducted Emissions Measurement Results

The Si3404-ISO-FB, 3.3 V, Class 3 EVB board's conducted emissions have been measured by two different measurement methods to comply with the international EN 55032 standard. The EVB is supplied and measured on its PoE input port as shown in the following figure.

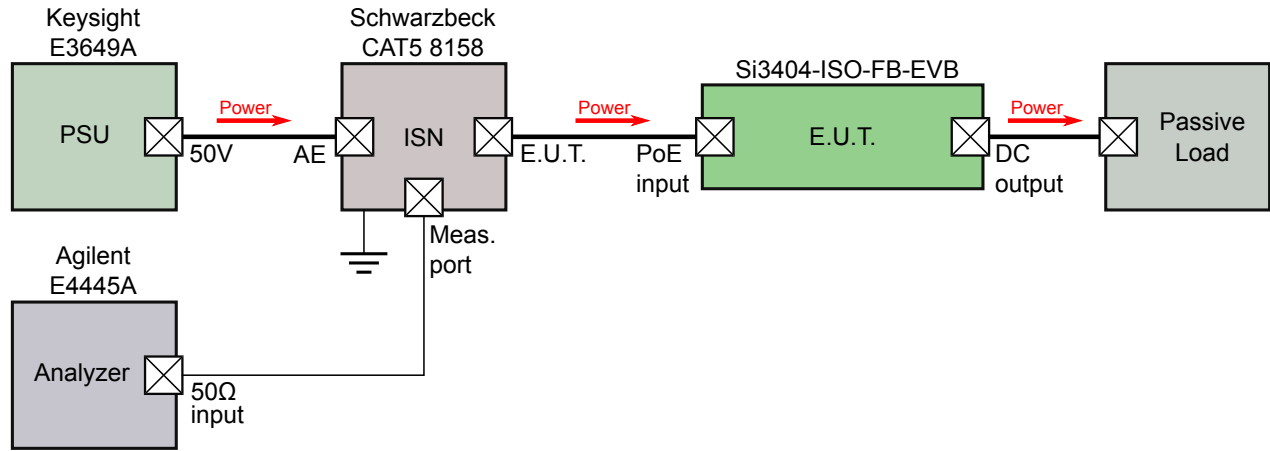

Figure 3.15. Conducted EMI Measurement Setup

The detector in the spectrum analyzer is set to:

- Peak detector and
- Average detector

Both results are shown in the following figure:

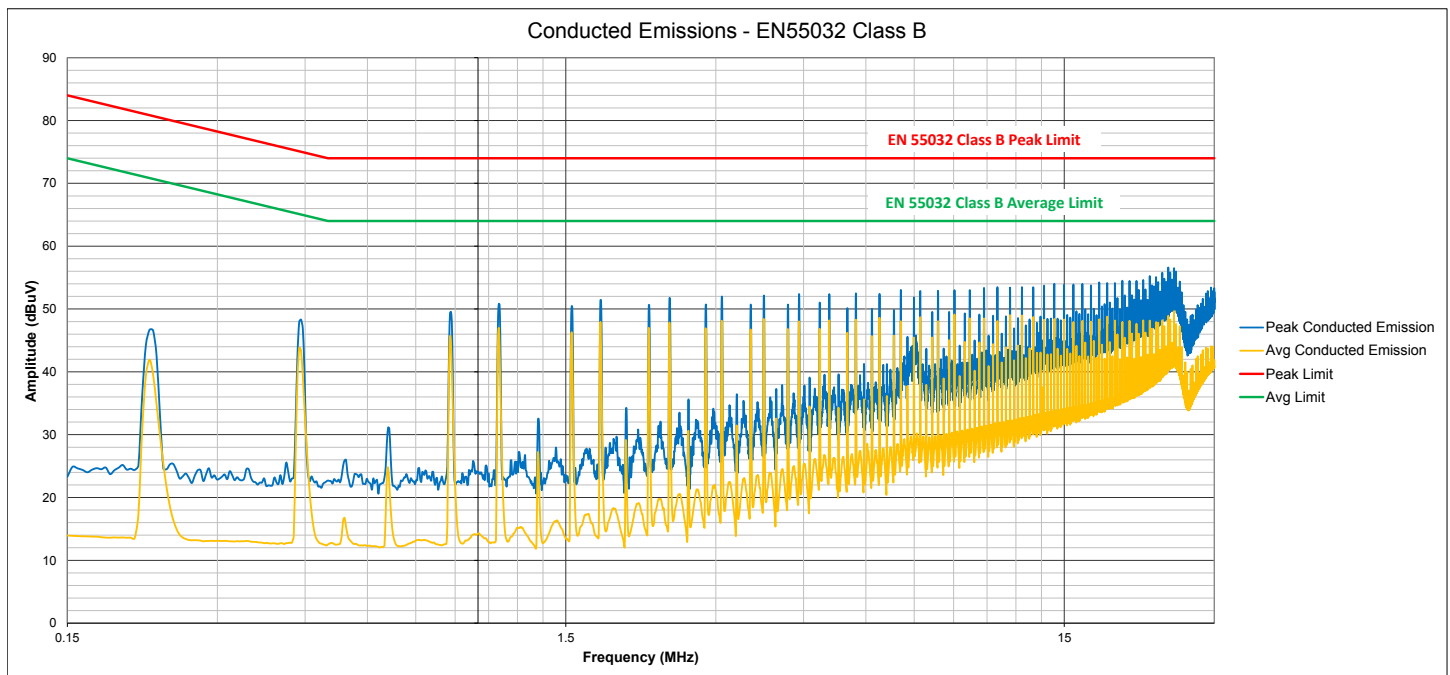

Figure 3.16. Si3404-ISO-FB EVB Conducted Emissions Measurements Results; 50 V Input, 3.3 V Output, 15 W Input Power

3.15 Bill of Materials

The following table is the BOM listing for the standard 3.3 V output evaluation board with option PoE Class 3.

Table 3.7. Si3404 Isolated Flyback 3.3 V Bill of Materials

Reference	Quantity	Description	Manufacturer	Manufacturer Part Number
C1, C28	2	Capacitor, 1 nF, 3000 V, $\pm 10\%$, X7R, 1808	Venkel	C1808X7R302-102K
C10	1	Capacitor, 1000 μF , 6.3 V, $\pm 20\%$, AL, 8X11.5MM	Panasonic	ECA0JM102
C14	1	Capacitor, 0.33 μF , 50 V, $\pm 10\%$, X7R, 0805	Venkel	C0805X7R500-334K
C15	1	Capacitor, 1 μF , 50 V, $\pm 10\%$, X7R, 0805	Samsung	CL21B105KBFNNNE
C2	1	Capacitor, 0.01 μF , 100 V, $\pm 10\%$, X7R, 0805	Venkel	C0805X7R101-103K
C20	1	Capacitor, 0.1 μF , 100 V, $\pm 10\%$, X7R, 0805	Venkel	C0805X7R101-104K
C21	1	Capacitor, 0.1 μF , 16 V, $\pm 10\%$, X7R, 0805	Venkel	C0805X7R160-104K
C26	1	Capacitor, 1.5 nF, 50 V, $\pm 1\%$, C0G, 0805	Venkel	C0805C0G500-152F
C27	1	Capacitor, 15 nF, 16 V, $\pm 10\%$, X7R, 0805	Venkel	C0805X7R160-153K
C3	1	Capacitor, 2.2 nF, 50 V, $\pm 1\%$, C0G, 0805	Venkel	C0805C0G500-222F
C4	1	Capacitor, 12 μF , 100 V, $\pm 20\%$, AL, 6.3X11.2MM	Panasonic	EEUFC2A120
C5, C6	2	Capacitor, 1 μF , 100 V, $\pm 10\%$, X7R, 1210	Venkel	C1210X7R101-105K
C7	1	Capacitor, 0.01 μF , 100V, $\pm 10\%$, X7R, 0603	Venkel	C0603X7R101-103K
C8	1	Capacitor, 1 μF , 25V, $\pm 10\%$, X5R, 0603	Venkel	C0603X5R250-105K
C9	1	Capacitor, 100 μF , 6.3V, $\pm 10\%$, X5R, 1210	Venkel	C1210X5R6R3-107K
D1	1	Diode, Schottky, 45 V, 10 A, Power-DI-5	Diodes Inc.	SDT10A45P5-7
D2	1	LED, Green, 0805	Lite On, Inc.	LTST-C170GKT
D3, D5, D6, D7, D8, D10, D11, D12, D13	9	Diode, Single, 100V, 1.0A, SMA	Fairchild	S1B
D4	1	Diode, Single, 100 V, 300 mA, SOD123	Diodes Inc.	1N4148W-7-F
J1, J3	2	Connector, Banana Jack, Threaded uninsulated	Abbatron HH Smith	101
J2	1	Connector, RJ-45, MAGJACK, 1 Port PoE	Bel	SI-52003-F

Reference	Quantity	Description	Manufacturer	Manufacturer Part Number
L1, L3	2	Ferrite Bead, 700 Ω @150MHZ, 0805	Wurth	742792040
R10	1	Resistor, 2 k Ω , 1/8 W, \pm 1%, Thick Film, 0805	Venkel	CR0805-8W-2001F
R11	1	Resistor, 360 Ω , 1/8 W, \pm 1%, Thick Film, 0805	Venkel	CR0805-8W-3600F
R12	1	Resistor, 36.5 k Ω , 1/10 W, \pm 1%, Thick Film, 0805	Venkel	CR0805-10W-3652F
R14	1	Resistor, 88.7 k Ω , 1/8 W, \pm 1%, Thick Film, 0805	Vishay	CRCW080588K7FKEA
R15	1	Resistor, 24.3 k Ω , 1/8 W, \pm 1%, Thick Film, 0805	Vishay	CRCW080524K3FKEA
R17	1	Resistor, 48.7 Ω , 1/8 W, \pm 1%, Thick Film, 0805	Vishay	CRCW080548R7FKTA
R18	1	Resistor, 21.5 k Ω , 1/10 W, \pm 1%, Thick Film, 0805	Venkel	CR0805-10W-2152F
R2	1	Resistor, 0 Ω , 6 A, Thick Film, 0805	Vishay Dale	CRCW08050000Z0EAHP
R3	1	Resistor, 82 k Ω , 1/10 W, \pm 5%, Thick Film, 0805	Venkel	CR0805-10W-823J
R4	1	Resistor, 5.6 Ω , 1/10 W, \pm 5%, Thick Film, 0805	Venkel	CR0805-10W-5R6J
R5	1	Resistor, 475 Ω , 1/8 W, \pm 1%, Thick Film, 0805	Venkel	CR0805-8W-4750FT
R6, R13, R16	3	Resistor, 0 Ω , 2 A, Thick Film, 0805	Venkel	CR0805-10W-000
R7	1	Resistor, 3 Ω , 1/8 W, \pm 1%, Thick Film, 0805	Venkel	CR0805-8W-3R00FT
R8	1	Resistor, 0.62 Ohm, 1/8 W, \pm 1%, Thick Film, 0805	Yageo	RL0805FR-070R62L
R9	1	Resistor, 10 Ω , 1/10 W, \pm 1%, Thick Film, 0805	Venkel	CR0805-10W-10R0F
T1	1	Transformer, Flyback, PoE, 127 μ H, 15 W, Aux winding, SMT	Wurth Elektronik	749119933
TP1, TP2, TP8, TP10, TP15, TP16	6	Testpoint, Black, 0.050" Loop, PTH	Keystone	5001
U1	1	IC, Fully-Integrated 802.3-Compliant PoE PD Interface and Low-EMI Switching Regulator, QFN20	Skyworks	Si3404-A-GM
U2	1	Photocoupler, 5000 Vrms Isolation, 4-Pin SMD	Vishay	FOD817A3SD
U3	1	IC, Adjustable Precision Shunt Regulator LV SOT-23 Voltage-Output 1.24 ~ 6 V	TI	TLV431BCDBZR
Not Installed Components				
C11, C12, C13	3	Capacitor, 100 μ F, 6.3 V, \pm 10%, X5R, 1210	Venkel	C1210X5R6R3-107K

Reference	Quantity	Description	Manufacturer	Manufacturer Part Number
C16, C17, C18, C19, C22, C23, C24, C25	8	Capacitor, 1nF, 100 V, ±10%, X7R, 0603	Venkel	C0603X7R101-102K
D9	1	Diode, Transient-voltage-suppres- sion, Unidirectional, 58 V, 400 W	Littelfuse	SMAJ58A
L2	1	Inductor, Power, Shielded, 0.16 µH, 31 A, SMD	Coilcraft	XAL5030-161ME
R1	1	Resistor, 1 kΩ, 1/10 W, ±1%, Thick Film, 0805	Venkel	CR0805-10W-1001F
TP3, TP4, TP5, TP6, TP7, TP9, TP11, TP12, TP13, TP14	10	Testpoint, Black, 0.050" Loop, PTH	Keystone	5001

4. Si3404-ISO-FB EVB: 5 V, Class 3 Configuration

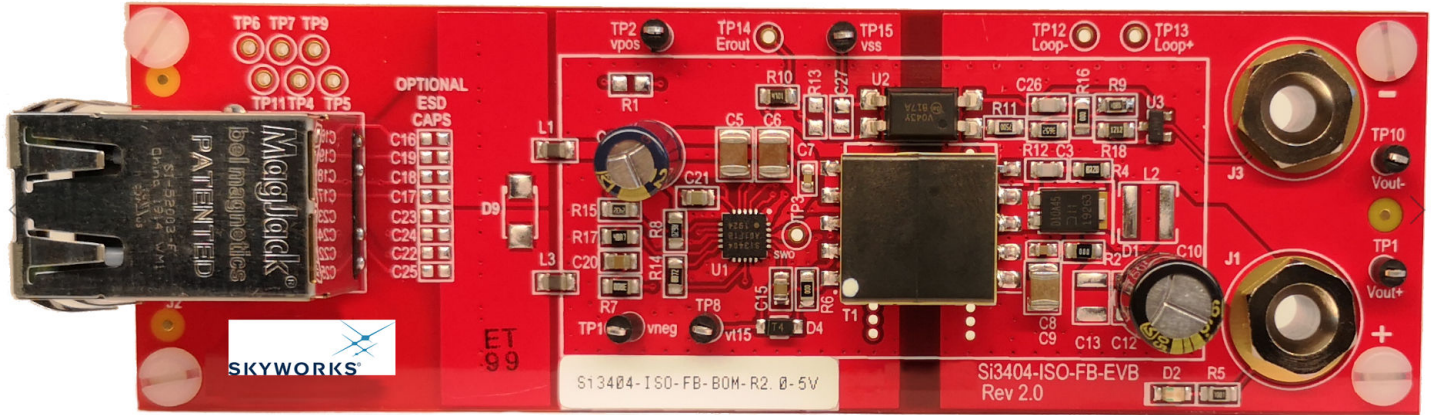

4.1 Si3404-ISO-FB EVB Schematic: 5 V, Class 3, 15.4 W

The figure below shows the schematic of the Si3404-ISO-FB 5 V, Class 3 EVB. The parts in red in the schematic represent the BOM differences compared to the other output voltage variant of this EVB. The parts in gray are not installed on the EVB, but they have footprints.

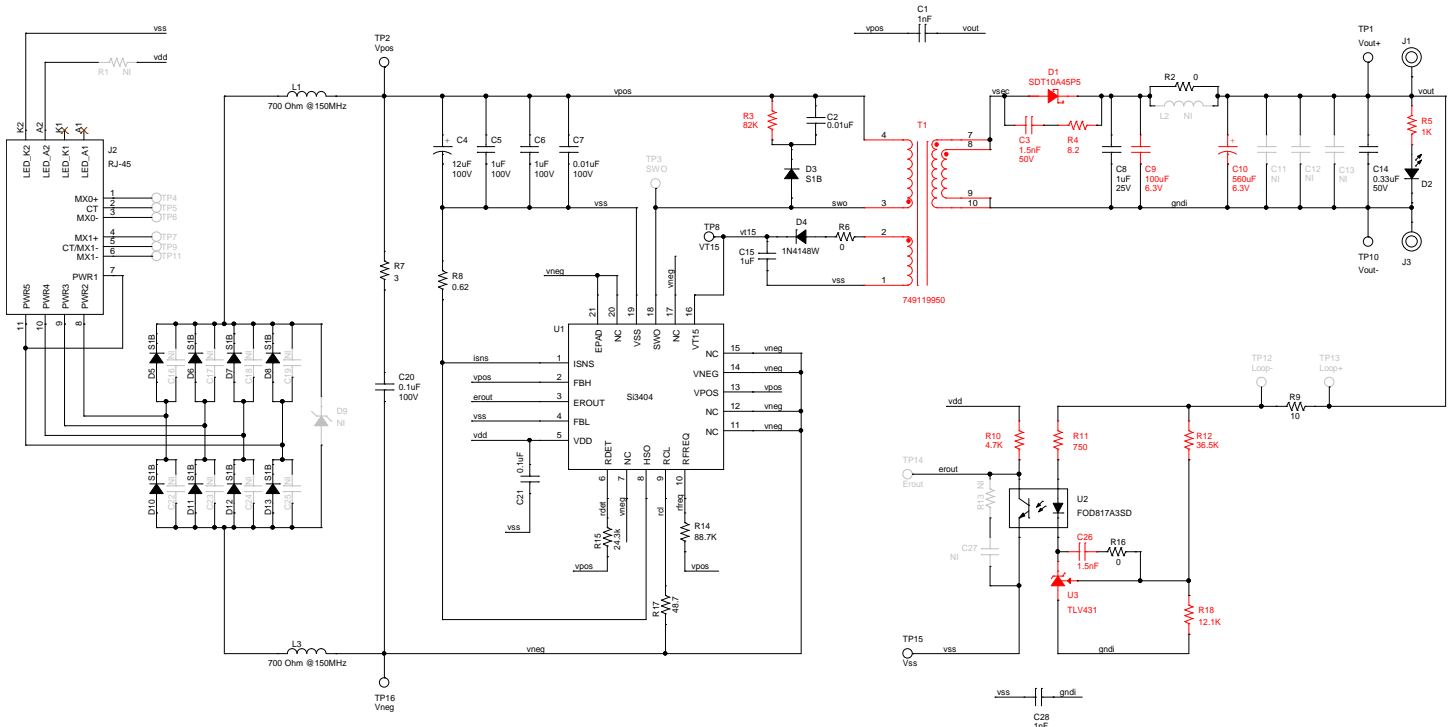

Figure 4.1. Si3404-ISO-FB EVB Schematic: 5 V, Class 3 PD, 15.4 W

4.2 End-to-End EVB Efficiency

The end-to-end efficiency measurement data of the Si3404-ISO-FB 5V EVB is shown in the figures below. Efficiency was measured from PoE (RJ45 connector) input to the 5 V output. The efficiency was measured at three different input voltage levels, 39.9 V, 50 V and 57 V, with two input diode bridge configurations: silicon (S1B) and Schottky (SS2150).

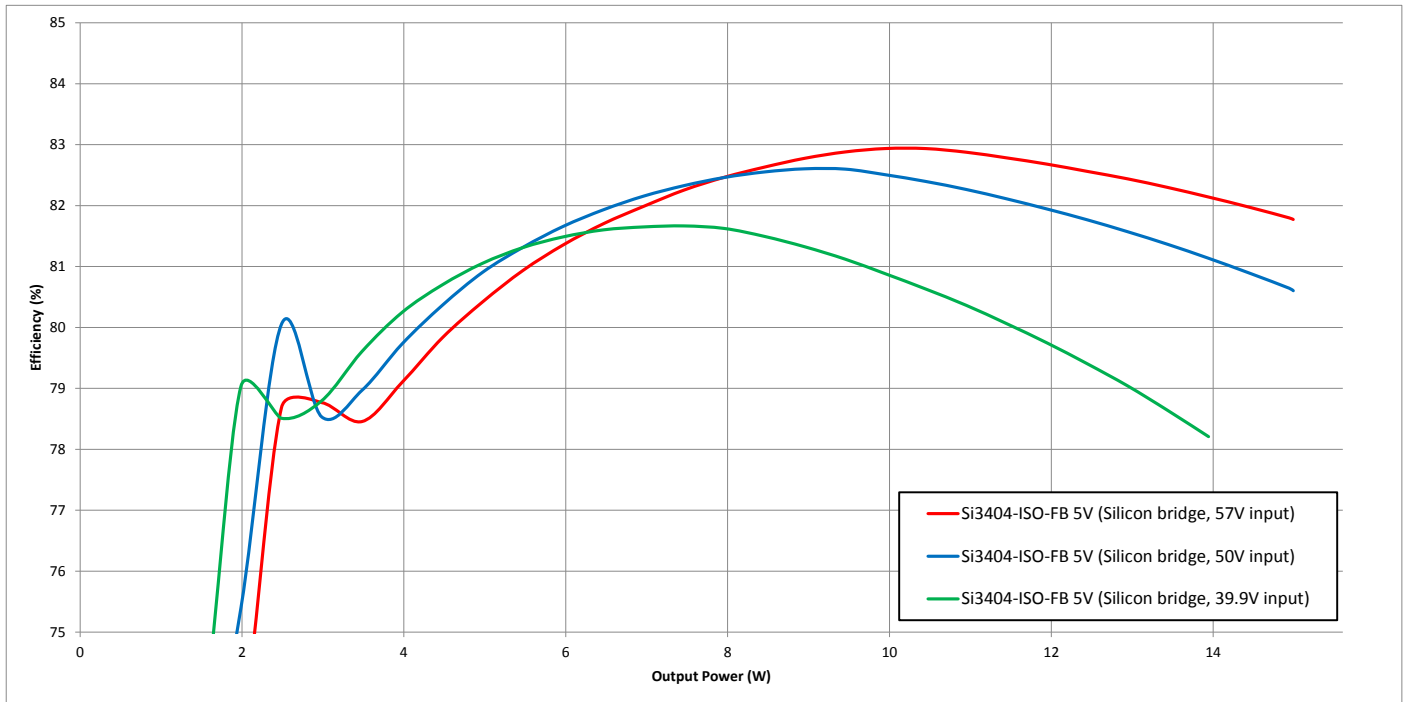

Figure 4.2. Si3404-ISO-FB End-to-End Efficiency Chart with Silicon Type Input Bridge Diodes: Multiple Input Voltages, 5 V Output, Class 3

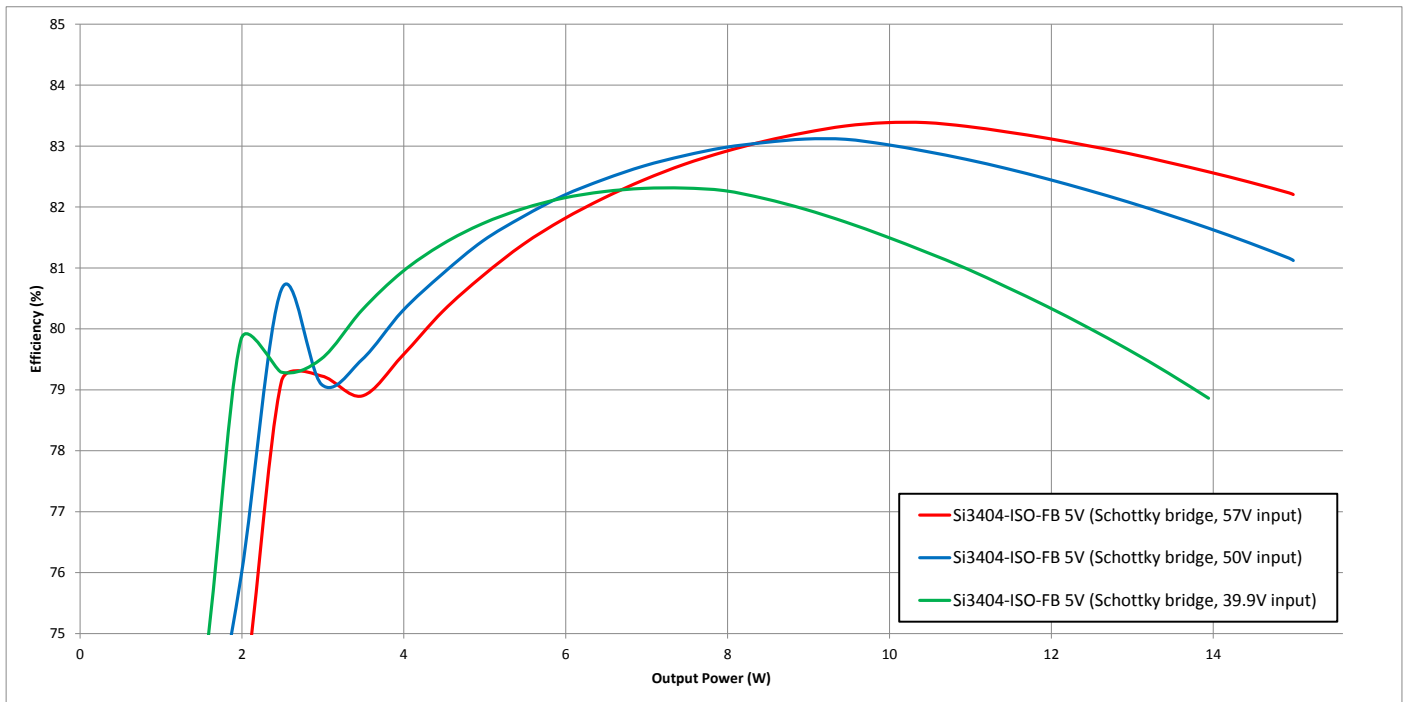

Figure 4.3. Si3404-ISO-FB End-to-End Efficiency Chart with Schottky Type Input Bridge Diodes: Multiple Input Voltages, 5 V Output, Class 3

Note: The charts show end-to-end EVB efficiency. The voltage drop of the diode bridge is included. LEDs are removed.

4.3 Thermal Measurements

The Si3404-ISO-FB EVB's temperature was measured at maximum **input power – 13 W**. The Si3404-ISO-FB EVB is configured for 5 V output voltage and Class 3 power level. The following figure shows the thermal images taken of the EVB board at maximum input power.

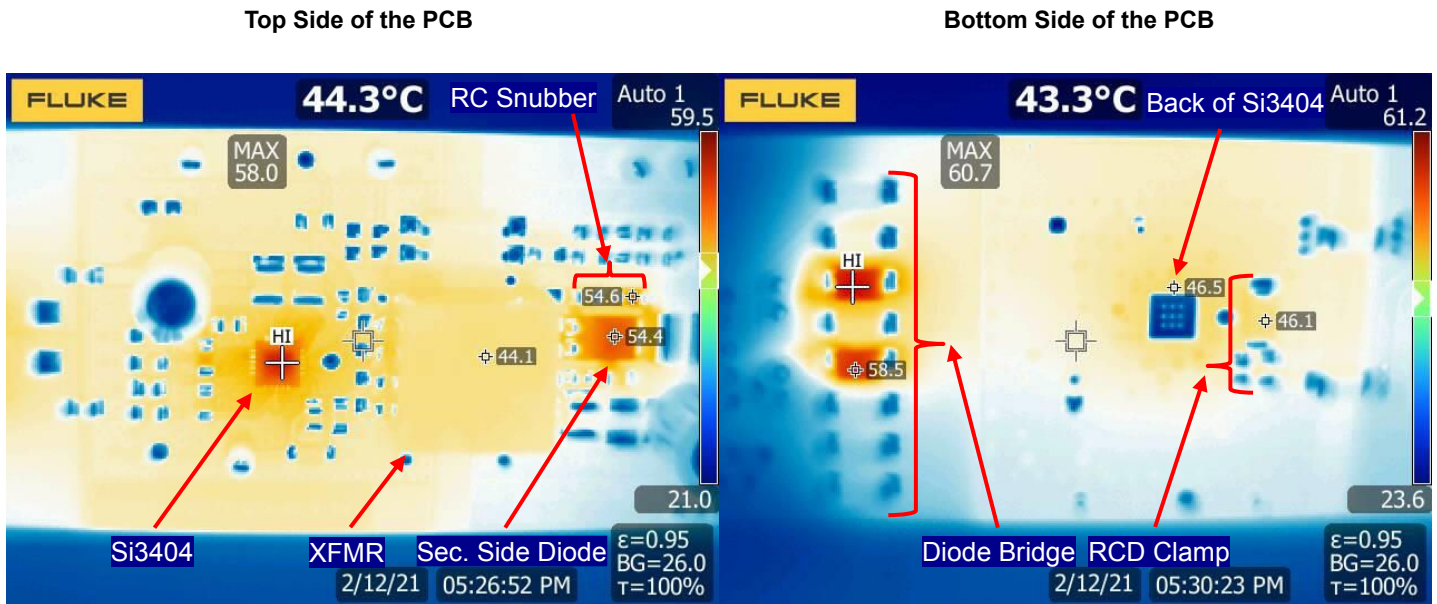

Figure 4.4. Thermal Measurements of the Si3404-ISO-FB EVB, 5 V, Class 3 PD

The following table lists the temperatures of the notable components across the board.

Table 4.1. Component Temperatures at Full Load

Component	Temperature ¹
Si3404 – U1	58.0 °C
Flyback Transformer – T1	44.1 °C
Secondary Side Diode – D1	54.4 °C
Secondary Side RC Snubber – C3–R4	54.6 °C
Diode Bridge – D5–D8, D10–D13	60.7 °C
Primary Side RCD Clamp – R3-C2-D3	46.1 °C
Note:	
1. The ambient temperature was 26 °C during the thermal measurements.	

4.4 Sifos PoE Compatibility Test Results

The PDA-604A Powered Device Analyzer is a single-box comprehensive solution for testing IEEE 802.3at and IEEE 802.3bt PoE Powered Devices (PDs). The Si3404-ISO-FB 5 V EVB board has been successfully tested with the PDA-604A Powered Device Analyzer from Sifos Technologies.

Unlike the Si3406x family, the Si3404 does not incorporate the MPS feature. To prevent PSE shutdown, a minimal 20R load was applied to the Si3404-ISO-FB 5 V EVB's output during the Sifos tests.

See 10. Complete 5 V Si3404 Isolated Flyback Sifos Compatibility Test Reports for more information.

4.5 Adjustable EVB Current Limit

For additional safety, the Si3404 has an adjustable EVB current limit feature.

The Si3404 controller measures the voltage on the R_{SENSE} resistor (R8) through the ISNS pin. Care must be taken that this voltage goes below V_{SS} . When the voltage on R8 is $V_{ISNS} = -270$ mV (referenced to V_{SS}), the internal current limit circuit restarts the PD to protect the application.

The EVB current limit for this Class 3 application can be calculated with the following formula:

$$R_{SENSE} = 0.62\Omega$$

$$I_{LIMIT} = \frac{270mV}{0.62\Omega} = 435mA$$

Equation 4.1. EVB Class 3 Current Limit

4.6 Feedback Loop Phase and Gain Measurement Results (Bode Plots)

The Si3404 device integrates a current-mode-controlled switching mode power supply controller circuit. Therefore, the application is a closed-loop system. To guarantee stable output voltage of the power supply and to reduce the influence of the input voltage variations and load changes on the output voltage, the feedback loop should be stable.

To verify the stability of the loop, the gain and phase of the loop has been measured.

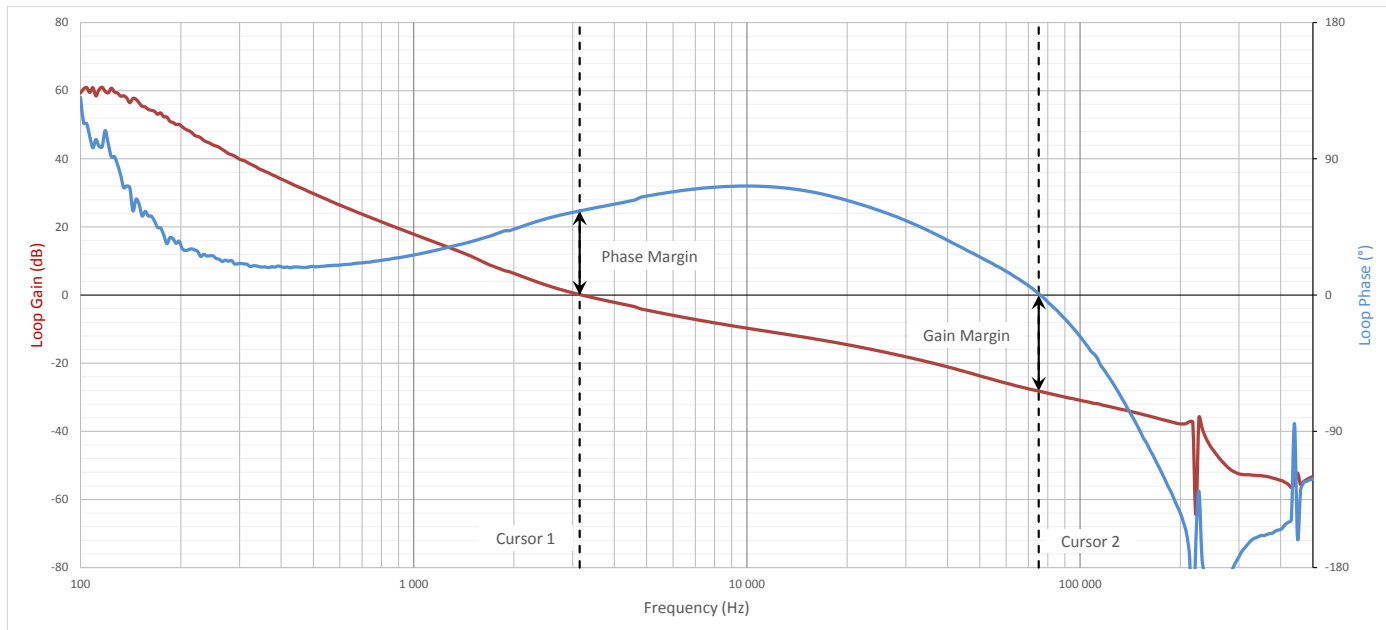

Figure 4.5. Si3404-ISO-FB EVB, 5 V, Class 3 PD Feedback Loop Measurement Results at Light Load

Table 4.2. Measured Loop Gain and Phase Margin at Light Load

	Frequency	Gain	Phase
Cursor 1 (Phase Margin)	3.2 kHz	0 dB	55.88 °
Cursor 2 (Gain Margin)	75.99 kHz	-28.29 dB	0 °

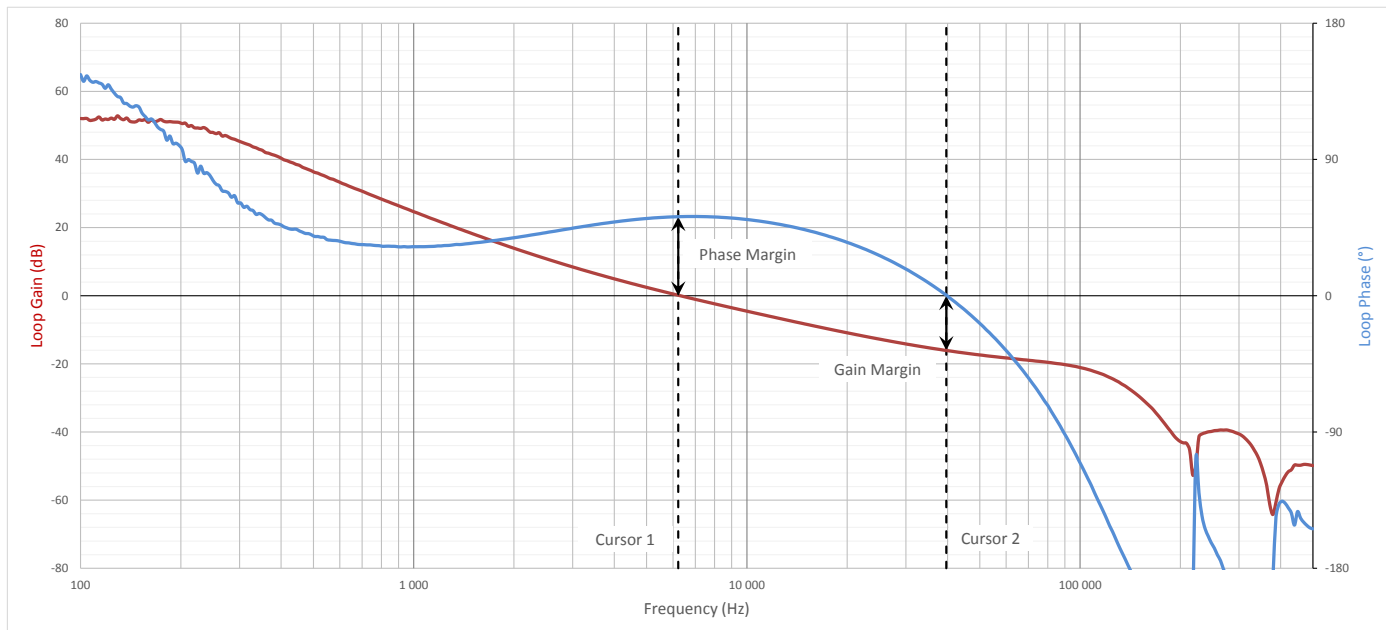

Figure 4.6. Si3404-ISO-FB EVB, 5 V, Class 3 PD Feedback Loop Measurement Results at Full Load

Table 4.3. Measured Loop Gain and Phase Margin at Full Load

	Frequency	Gain	Phase
Cursor 1 (Phase Margin)	6.31 kHz	0 dB	52.25 °
Cursor 2 (Gain Margin)	39.9 kHz	-16.09 dB	0 °

The following table sums up the circumstances of the feedback loop measurements.

Table 4.4. Feedback Loop Measurements Circumstances

Measurement Name	Input Voltage	Output Load
Feedback Loop Measurement at Light Load	50 V	20 R
Feedback Loop Measurement at Full Load	50 V	2 R

4.7 Load Step Transient Measurement Results

The output of the Si3404-ISO-FB EVB board has been tested with a load step function to verify the converter's output dynamic response.

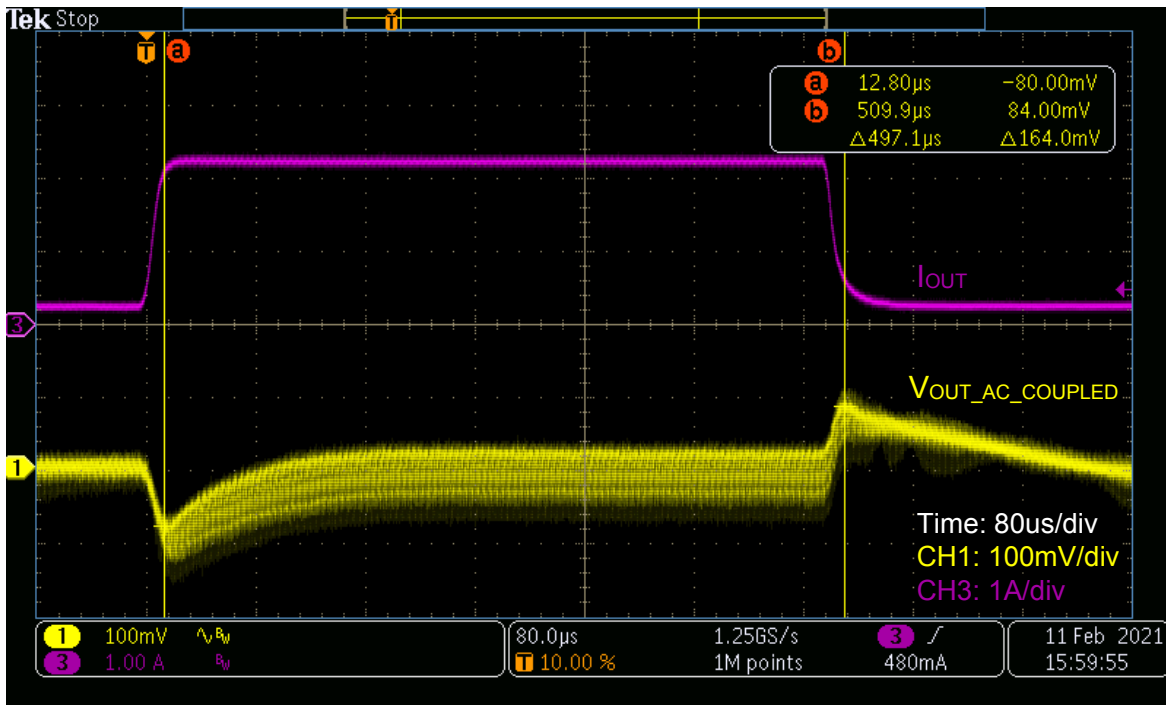

Figure 4.7. Si3404-ISO-FB EVB, 5 V, Class 3 PD Output Load Step Transient Test

The following table sums up the results of the load step measurement.

Table 4.5. Output Load Step Transient Results

	From (Output Current)	To (Output Current)	Slew Rate (Output Current)	V _{OUT} Change
Stepping up the load	0.25 A	2.25 A	2500 mA/µs	5 V – 80 mV
Stepping down the load	2.25 A	0.25 A	2500 mA/µs	5 V + 84 mV

4.8 Output Voltage Ripple

The Si3404-ISO-FB EVB output voltage ripple has been measured under both No-Load and Heavy-Load conditions.

No-Load V_{OUT} Ripple = 14.4 mV

Heavy-Load V_{OUT} Ripple = 81 mV

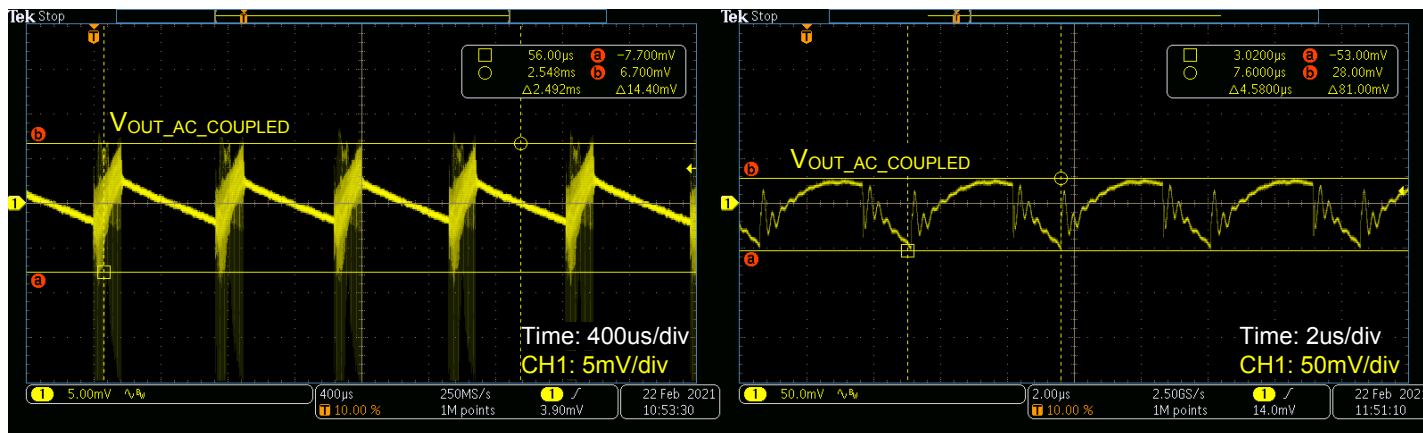

Figure 4.8. Si3404-ISO-FB EVB, 5 V, Class 3 Output Voltage Ripple No Load (Left) and Heavy Load (Right) Conditions

4.9 Soft-Start Protection

The Si3404 device has an integrated dynamic soft-start protection mechanism to avoid stressing the components by the sudden current or voltage changes associated with the initial charging of the output capacitors.

The Si3404 intelligent adaptive soft-start mechanism does not require any external component to install. The controller continuously measures the input current of the PD and dynamically adjusts the internal I_{PEAK} limit during soft-start, thus adjusting the output voltage ramp-up time as a function of the attached load.

The controller allows the output voltage to rise faster in no load (or light load) conditions. With a heavy load at the output, the controller slows down the output voltage ramp to avoid exceeding the desired regulated output voltage value.

No-Load Soft-Start $t_{RISE} = 5.5$ ms

Heavy-Load Soft-Start $t_{RISE} = 37.9$ ms

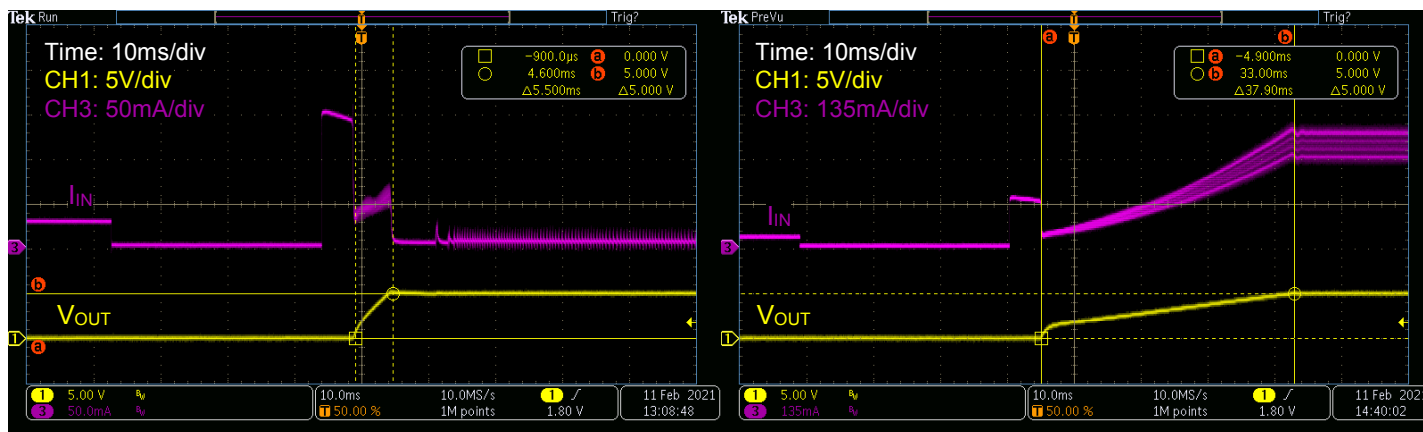

Figure 4.9. Si3404-ISO-FB EVB, 5 V, Class 3 Output Voltage Soft-Start at Low Load (Left) and Heavy Load (Right) Conditions

4.10 Output Short Protection

The Si3404 has an integrated output short protection mechanism, which protects the IC and surrounding external components from overheating in case of an electrical short on the output.

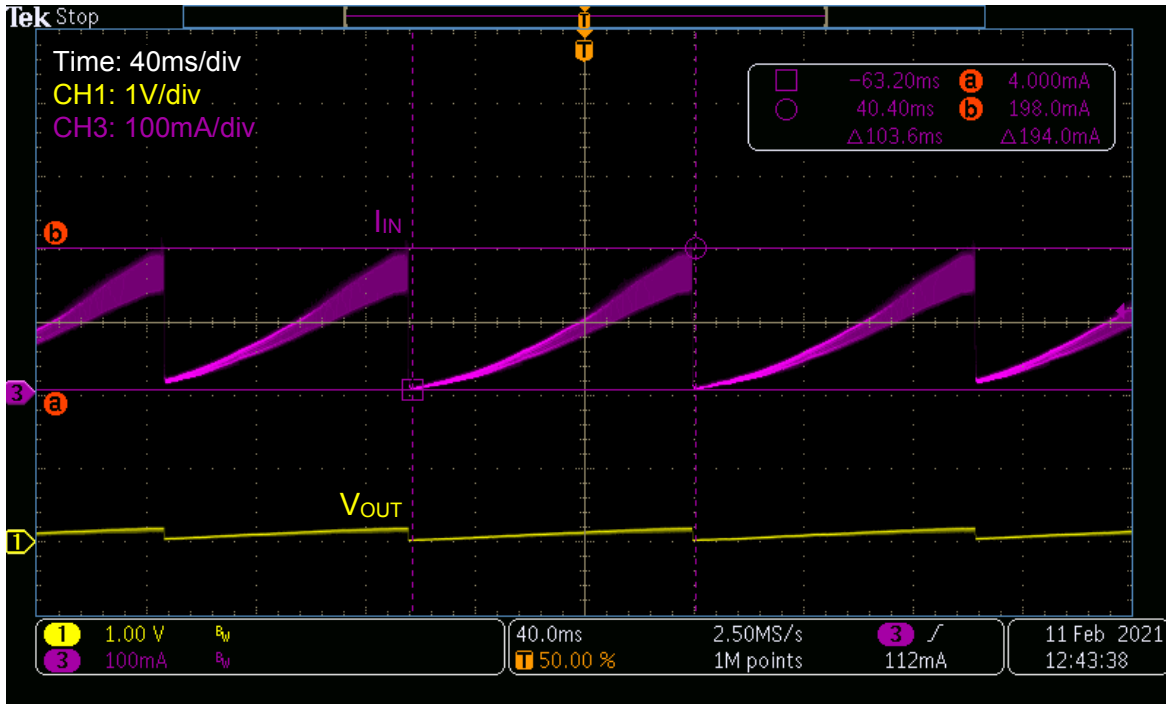

Figure 4.10. Si3404-ISO-FB EVB, 5 V, Class 3 Output Short Circuit Protection

4.11 Pulse Skipping at No-Load Condition

The Si3404 device has an integrated pulse skipping mechanism to ensure ultra-low power consumption under light load conditions.

As the output load decreases, the controller starts to reduce the pulse-width of the PWM signal (switcher ON time). At some point, even the minimum width pulse will provide higher energy than the application requires, which could result in a loss of voltage regulation.

When the controller detects a light load condition (which requires less ON time than the minimum pulse width), the controller enters into pulse-skipping mode. This mode is shown in the following figure, which depicts the switching node of the integrated switching FET at a no-load condition.

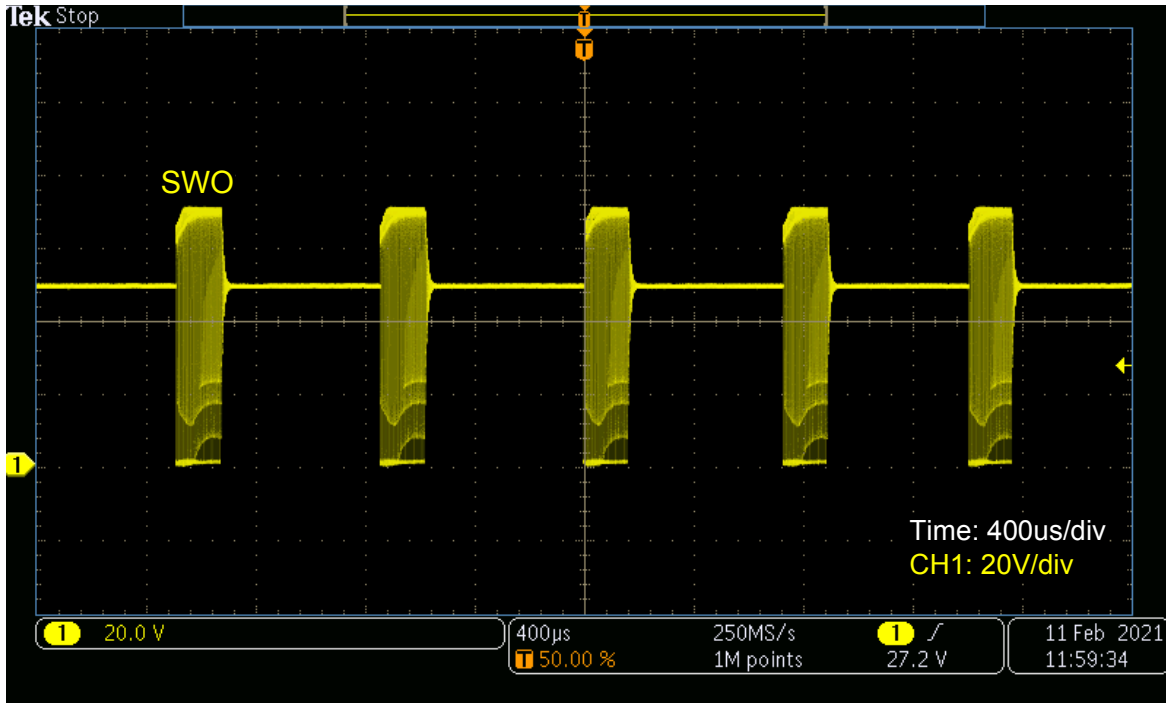

Figure 4.11. Si3404-ISO-FB EVB, 5 V, Class 3 Pulse Skipping at No-load Condition: SWO Waveform

4.12 Discontinuous (DCM) and Continuous (CCM) Conduction Modes

At low load, the converter works in discontinuous conduction mode (DCM). At heavy load, the converter runs in continuous conduction mode (CCM). At low load, the SWO voltage waveform has a ringing waveform, which is typical for DCM operation.

Low-Load, DCM

Heavy-Load, CCM

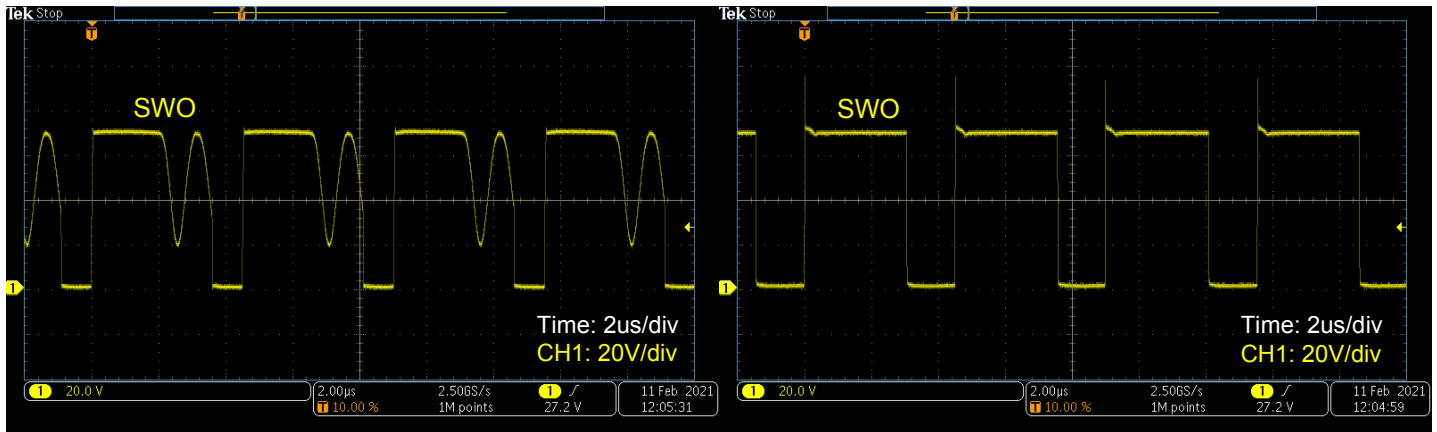

Figure 4.12. Si3404-ISO-FB EVB, 5 V, Class 3: SWO Waveform in Discontinuous Conduction Mode (DCM) at Low Load (Left), and in Continuous Conduction Mode (CCM) at Heavy Load (Right)

Similar voltage waveforms can be observed on the secondary side diode, D1. The voltage levels on the secondary side diode, D1, are much lower due to the transformer turns ratio; however, the discontinuous and continuous conduction mode characteristics are still present.

Low-Load, DCM

Heavy-Load, CCM

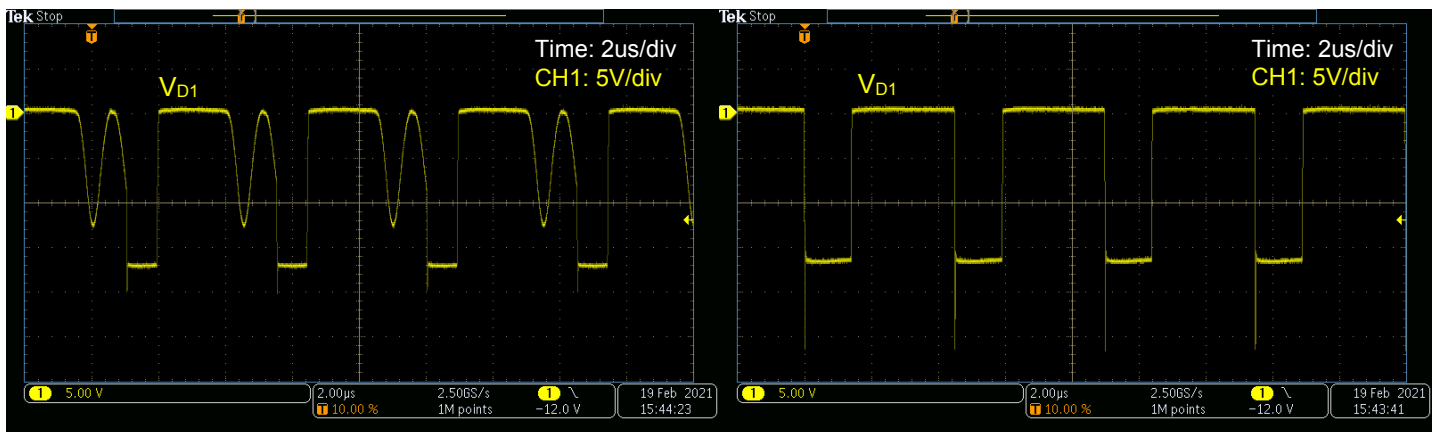

Figure 4.13. Si3404-ISO-FB EVB, 5 V, Class 3: Secondary Side Diode Voltage Waveform in Discontinuous Conduction Mode (DCM) at Low Load (Left), and in Continuous Conduction Mode (CCM) at Heavy Load (Right)

4.13 Radiated Emissions Measurement Results

Radiated emissions of the Si3404-ISO-FB, 5 V, Class 3 EVB board have been measured with 50 V input voltage and a full load connected to the output. The input power is 15 W in this case.

As shown below, the Si3404-ISO-FB, 5 V, Class 3 EVB is fully compliant with the international EN 55032 Class B emissions standard.

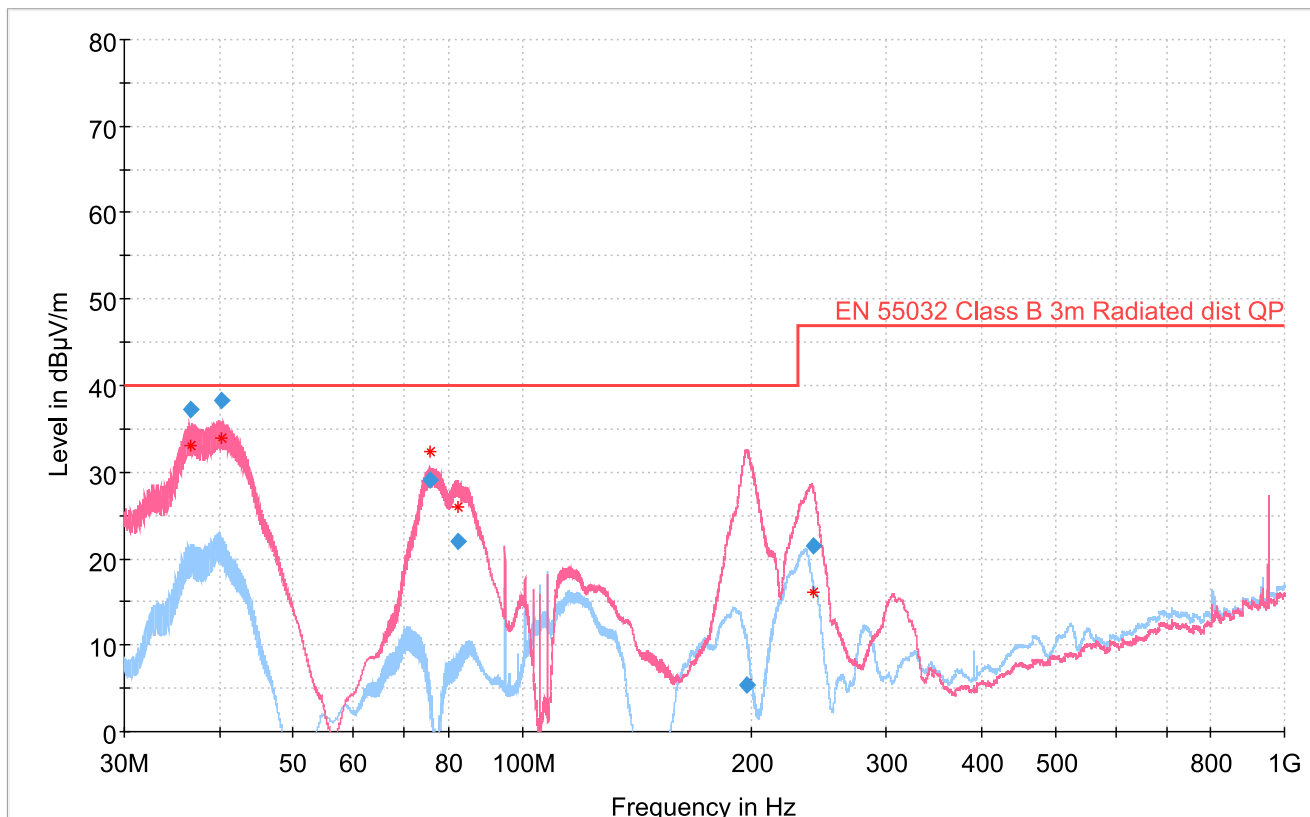

Figure 4.14. Si3404-ISO-FB EVB Radiated Emissions Measurements Results; 50 V Input, 5 V Output, 15 W Input Power

Table 4.6. Notable Peaks on The Radiated Emissions Chart

Frequency	Quasi Peak	Limit	Margin	Polarization
36.75 MHz	37.31 dBµV/m	40 dBµV/m	2.69 dB	Vertical
40.29 MHz	38.22 dBµV/m	40 dBµV/m	1.78 dB	Vertical
75.75 MHz	29.10 dBµV/m	40 dBµV/m	10.90 dB	Vertical
82.38 MHz	22.04 dBµV/m	40 dBµV/m	17.96 dB	Vertical
197.34 MHz	5.35 dBµV/m	40 dBµV/m	34.65 dB	Vertical
240.51 MHz	21.40 dBµV/m	47 dBµV/m	25.60 dB	Horizontal

The EVB is measured at full load with peak detection in both vertical and horizontal polarizations. This is a relatively fast process that produces a red curve (vertical polarization) and a blue curve (horizontal polarization).

Next, specific frequencies are selected (red stars) for quasi-peak measurements. The board is measured again at those specific frequencies with a quasi-peak detector, which is a very slow but accurate measurement. The results of this quasi-peak detector measurement are the blue rhombuses.

The blue rhombuses represent the final result of the measurement process. To have passing results, the blue rhombuses should be below the highlighted EN 55032 Class B limit.

4.14 Conducted Emissions Measurement Results

The Si3404-ISO-FB, 5 V, Class 3 EVB board's conducted emissions have been measured by two different measurement methods to comply with the international EN 55032 standard. The EVB is supplied and measured on its PoE input port as shown in the following figure.

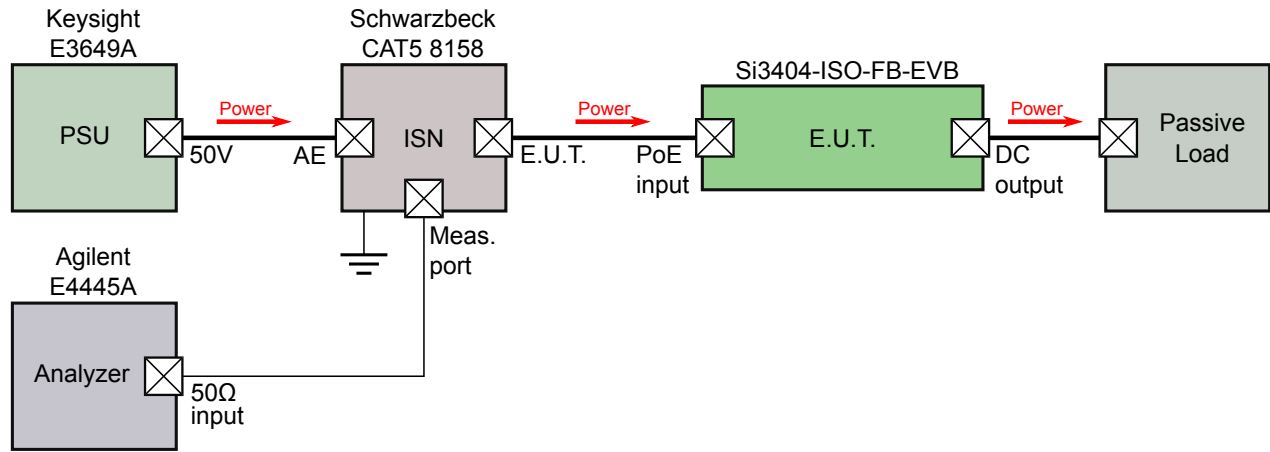

Figure 4.15. Conducted EMI Measurement Setup

The detector in the spectrum analyzer is set to:

- Peak detector and
- Average detector

Both results are shown in the following figure:

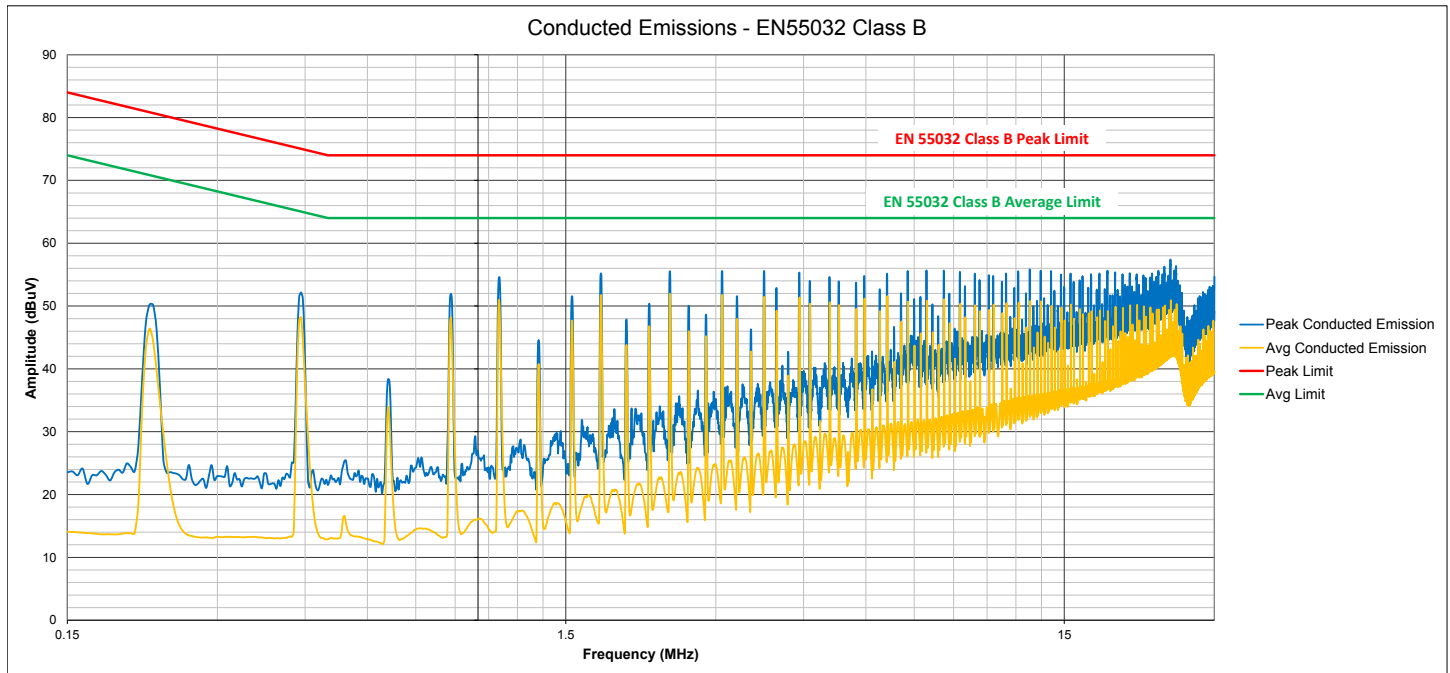

Figure 4.16. Si3404-ISO-FB EVB Conducted Emissions Measurements Results; 50 V Input, 5 V Output, 15 W Input Power

4.15 Bill of Materials

The following table is the BOM listing for the standard 5 V output evaluation board with option PoE Class 3.

Table 4.7. Si3404 Isolated Flyback 5 V Bill of Materials

Reference	Quantity	Description	Manufacturer	Manufacturer Part Number
C1, C28	2	Capacitor, 1 nF, 3000 V, ±10%, X7R, 1808	Venkel	C1808X7R302-102K
C10	1	Capacitor, 560 µF, 6.3 V, ±20%, AL, 8.0X11.5MM	Panasonic	EEUFM0J561
C14	1	Capacitor, 0.33 µF, 50 V, ±10%, X7R, 0805	Venkel	C0805X7R500-334K
C15	1	Capacitor, 1 µF, 50 V, ±10%, X7R, 0805	Samsung	CL21B105KBFNNNE
C2	1	Capacitor, 0.01 µF, 100 V, ±10%, X7R, 0805	Venkel	C0805X7R101-103K
C20	1	Capacitor, 0.1 µF, 100 V, ±10%, X7R, 0805	Venkel	C0805X7R101-104K
C21	1	Capacitor, 0.1 µF, 16 V, ±10%, X7R, 0805	Venkel	C0805X7R160-104K
C3, C26	2	Capacitor, 1.5 nF, 50 V, ±1%, C0G, 0805	Venkel	C0805C0G500-152F
C4	1	Capacitor, 12 µF, 100 V, ±20%, AL, 6.3X11.2MM	Panasonic	EEUFC2A120
C5, C6	2	Capacitor, 1 µF, 100 V, ±10%, X7R, 1210	Venkel	C1210X7R101-105K
C7	1	Capacitor, 0.01 µF, 100 V, ±10%, X7R, 0603	Venkel	C0603X7R101-103K
C8	1	Capacitor, 1 µF, 25 V, ±10%, X5R, 0603	Venkel	C0603X5R250-105K
C9	1	Capacitor, 100 µF, 6.3 V, ±10%, X5R, 1210	Venkel	C1210X5R6R3-107K
D1	1	Diode, Schottky, 45 V, 10 A, Power-DI-5	Diodes Inc.	SDT10A45P5-7
D2	1	LED, Green, 0805	Lite On Inc.	LTST-C170GKT
D3, D5, D6, D7, D8, D10, D11, D12, D13	9	Diode, Single, 100 V, 1.0 A, SMA	Fairchild	S1B
D4	1	Diode, Single, 100 V, 300 mA, SOD123	Diodes Inc.	1N4148W-7-F
J1 J3	2	Connector, Banana Jack, Threaded uninsulated	Abbatron HH Smith	101
J2	1	Connector, RJ-45, MAGJACK, 1 Port PoE	Bel	SI-52003-F
L1, L3	2	Ferrite Bead, 700 Ω @150 MHZ, 0805	Würth	742792040
R10	1	Resistor, 4.7 kΩ, 1/8 W, ±1%, Thick-Film, 0805	Venkel	CR0805-8W-4701F

Reference	Quantity	Description	Manufacturer	Manufacturer Part Number
R11	1	Resistor, 750 Ω , 1/8 W, $\pm 1\%$, Thick-Film, 0805	Venkel	CR0805-8W-7500FT
R12	1	Resistor, 36.5 k Ω , 1/10 W, $\pm 1\%$, ThickFilm, 0805	Venkel	CR0805-10W-3652F
R14	1	Resistor, 88.7 k Ω , 1/8 W, $\pm 1\%$, ThickFilm, 0805	Vishay	CRCW080588K7FKEA
R15	1	Resistor, 24.3 k Ω , 1/8 W, $\pm 1\%$, ThickFilm, 0805	Vishay	CRCW080524K3FKEA
R17	1	Resistor, 48.7 Ω , 1/8 W, $\pm 1\%$, Thick-Film, 0805	Vishay	CRCW080548R7FKTA
R18	1	Resistor, 12.1 k Ω , 1/10 W, $\pm 1\%$, ThickFilm, 0805	Venkel	CR0805-10W-1212F
R2	1	Resistor, 0 Ω , 6A, ThickFilm, 0805	Vishay Dale	CRCW08050000Z0EAHP
R3	1	Resistor, 82 k Ω , 1/10 W, $\pm 5\%$, Thick-Film, 0805	Venkel	CR0805-10W-823J
R4	1	Resistor, 8.2 Ω , 1/8W, $\pm 1\%$, Thick-Film, 0805	Yageo	RC0805FR-078R2L
R5	1	Resistor, 1 k Ω , 1/10 W, $\pm 1\%$, Thick-Film, 0805	Venkel	CR0805-10W-1001F
R6, R16	2	Resistor, 0 Ω , 2 A, ThickFilm, 0805	Venkel	CR0805-10W-000
R7	1	Resistor, 3 Ω , 1/8 W, $\pm 1\%$, Thick-Film, 0805	Venkel	CR0805-8W-3R00FT
R8	1	Resistor, 0.62 Ω , 1/8 W, $\pm 1\%$, Thick-Film, 0805	Yageo	RL0805FR-070R62L
R9	1	Resistor, 10 Ω , 1/10 W, $\pm 1\%$, Thick-Film, 0805	Venkel	CR0805-10W-10R0F
T1	1	Transformer, Flyback, PoE, 127 μ H, 15 W, Aux winding, SMT	Würth Elektronik	749119950
TP1, TP2, TP8, TP10, TP15, TP16	6	Testpoint, Black, 0.050" Loop, PTH	Keystone	5001
U1	1	IC, Fully-Integrated 802.3-Compliant PoE PD Interface and Low-EMI Switching Regulator, QFN20	Skyworks	Si3404-A-GM
U2	1	Photocoupler, 5000 Vrms Isolation, 4-Pin SMD	Vishay	FOD817A3SD
U3	1	IC, Adjustable Precision Shunt Regulator Low Voltage SOT-23 Voltage-Output 1.24 ~ 6 V	TI	TLV431BCDBZR
Not Installed Components				
C11, C12, C13	3	Capacitor, 100 μ F, 6.3 V, $\pm 10\%$, X5R, 1210	Venkel	C1210X5R6R3-107K
C16, C17, C18, C19, C22, C23, C24, C25	8	Capacitor, 1 nF, 100 V, $\pm 10\%$, X7R, 0603	Venkel	C0603X7R101-102K
C27	1	Capacitor, 0.01 μ F, 100 V, $\pm 10\%$, X7R, 0805	Venkel	C0805X7R101-103K

Reference	Quantity	Description	Manufacturer	Manufacturer Part Number
D9	1	Diode, TVS, Unidirectional, 58 V, 400 W	Littelfuse	SMAJ58A
L2	1	Inductor, Power, Shielded, 0.16 μ H, 31 A, SMD	Coilcraft	XAL5030-161ME
R1	1	Resistor, 1 k Ω , 1/10 W, \pm 1%, Thick Film, 0805	Venkel	CR0805-10W-1001F
R13	1	Resistor, 0 Ω , 2 A, Thick Film, 0805	Venkel	CR0805-10W-000
TP3, TP4, TP5, TP6, TP7, TP9, TP11, TP12, TP13, TP14	10	Tespoint, Black, 0.050" Loop, PTH	Keystone	5001

5. Si3404-ISO-FB EVB: 12 V, Class 3 Configuration

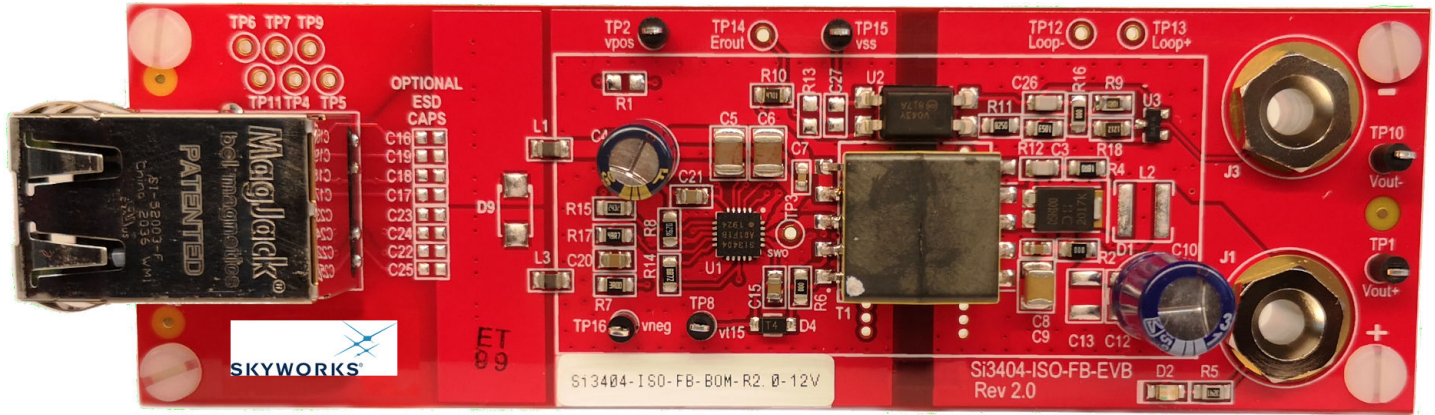

5.1 Si3404-ISO-FB EVB Schematic: 12 V Class 3, 15.4W

The figure below shows the schematic of the Si3404-ISO-FB 12 V, Class 3 EVB. The parts in red in the schematic represent the BOM differences compared to the other output voltage variant of this EVB. The parts in gray are not installed on the EVB, but they have footprints.

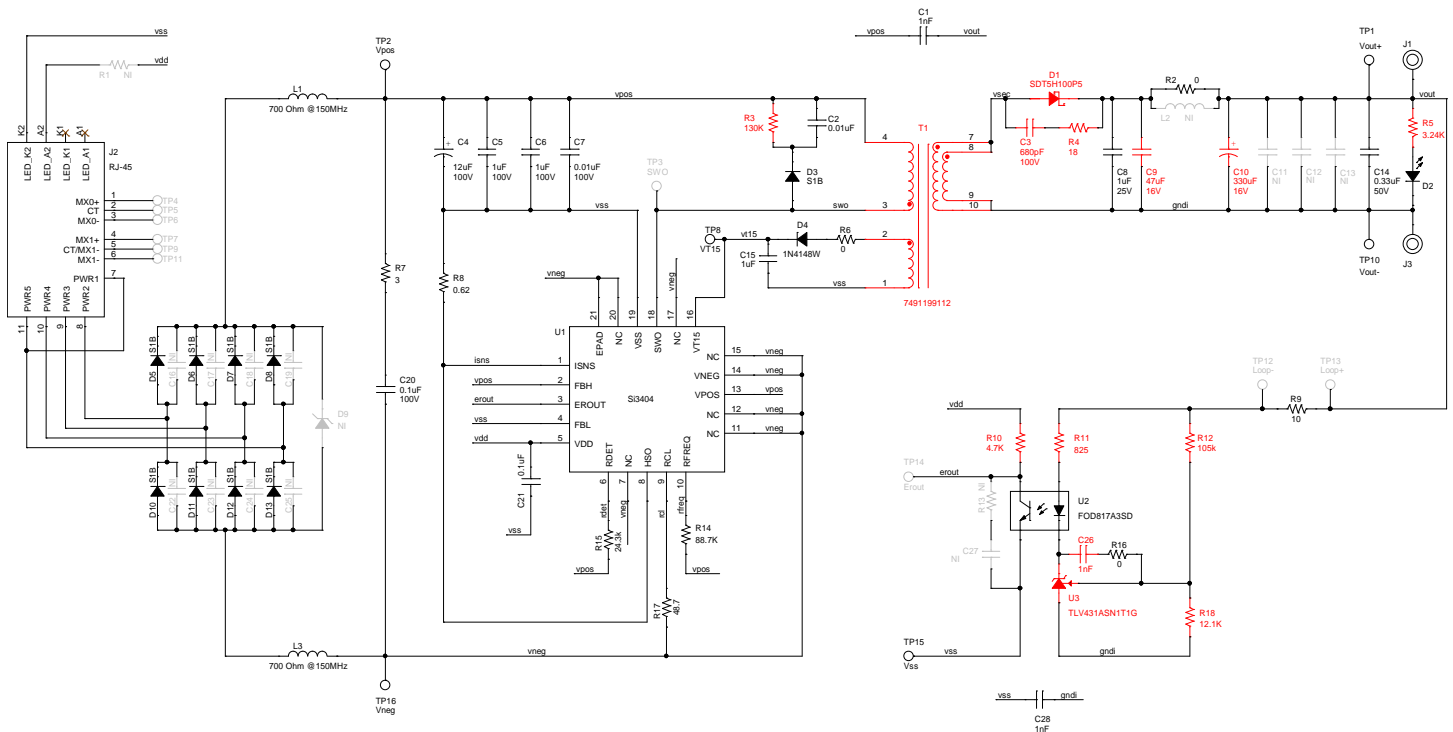

Figure 5.1. Si3404-ISO-FB EVB Schematic: 12 V, Class 3 PD, 15.4 W

5.2 End-to-End EVB Efficiency

The end-to-end efficiency measurement data of the Si3404-ISO-FB 12V EVB is shown in the figures below. Efficiency was measured from PoE (RJ45 connector) input to the 12 V output. The efficiency was measured at three different input voltage levels, 39.9 V, 50 V and 57 V, with two input diode bridge configurations: silicon (S1B) and Schottky (SS2150).

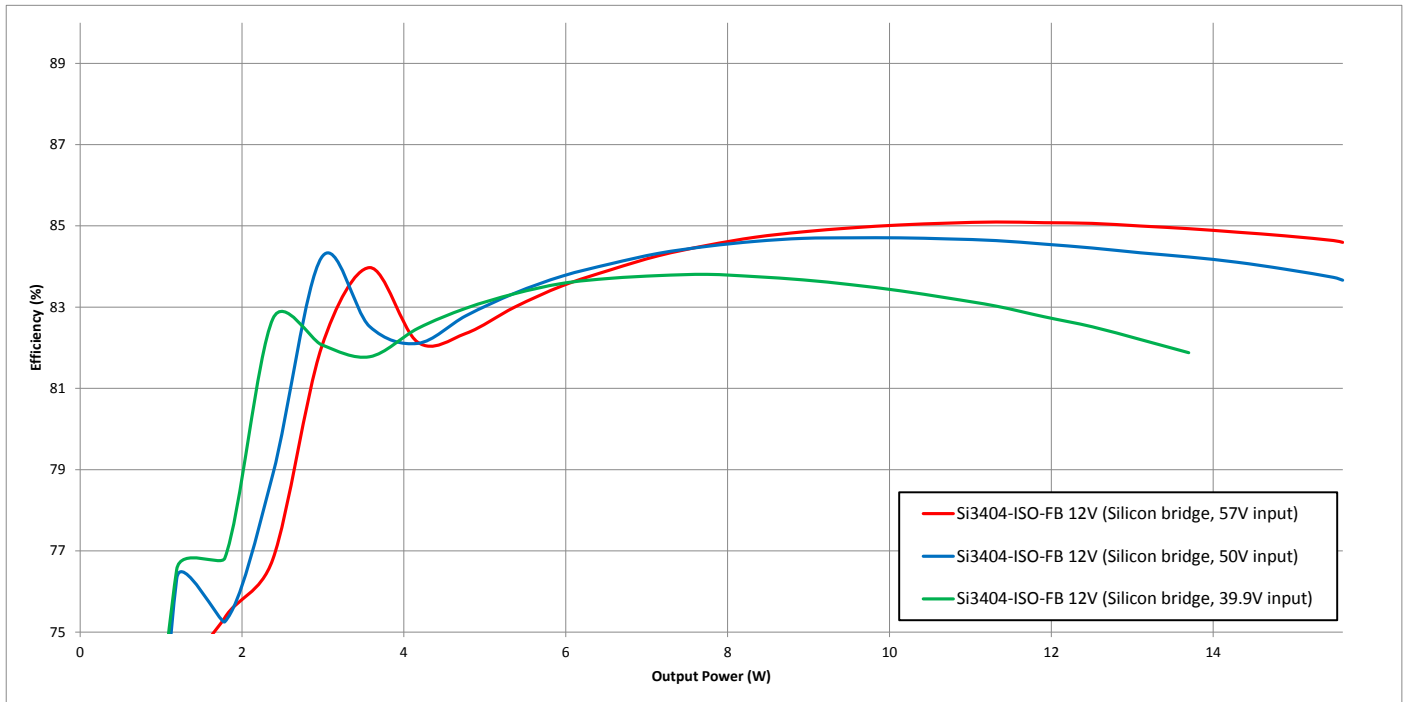

Figure 5.2. Si3404-ISO-FB End-to-End Efficiency Chart with Silicon Type Input Bridge Diodes: Multiple Input Voltages, 12 V Output, Class 3

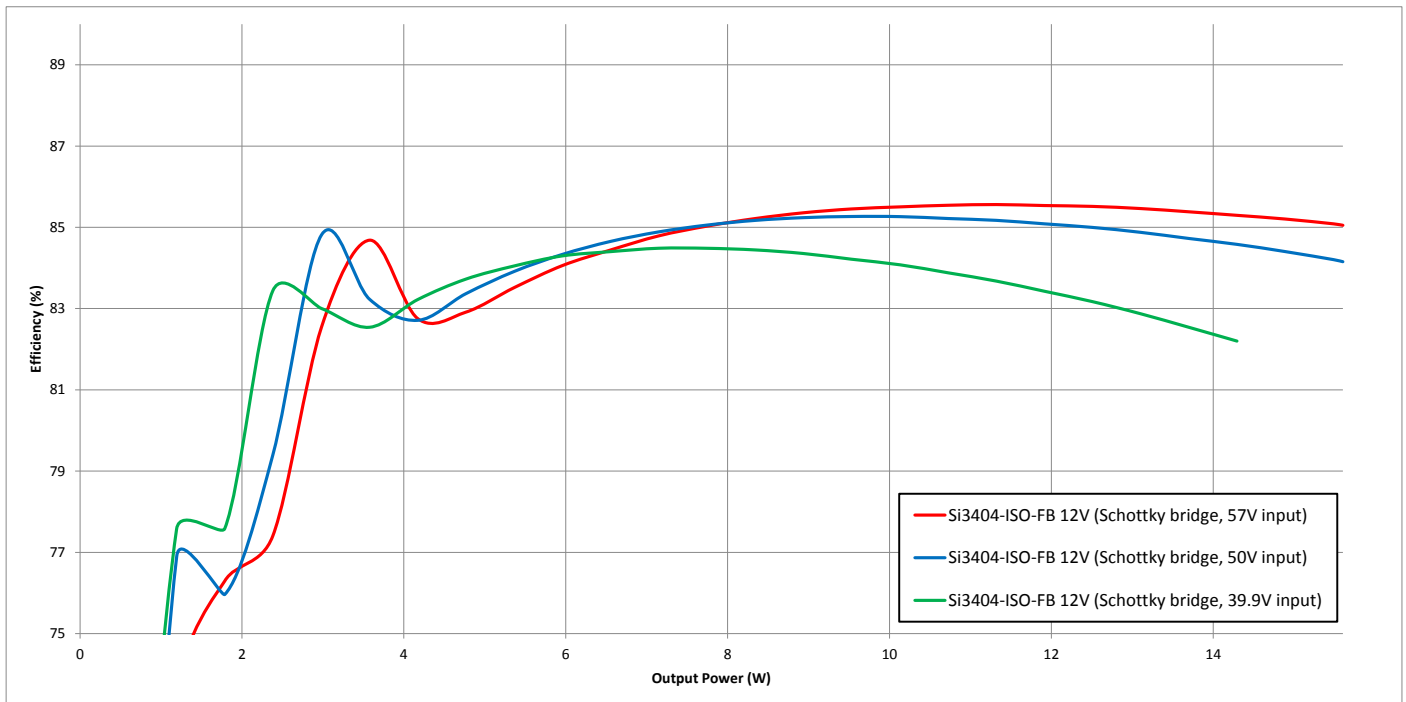

Figure 5.3. Si3404-ISO-FB End-to-End Efficiency Chart with Schottky Type Input Bridge Diodes: Multiple Input Voltages, 12 V Output, Class 3

Note: The charts show end-to-end EVB efficiency. The voltage drop of the diode bridge is included. LEDs are removed.

5.3 Thermal Measurements

The Si3404-ISO-FB EVB's temperature was measured at maximum **input power – 13 W**. The Si3404-ISO-FB EVB is configured for 12 V output voltage and Class 3 power level. The following figure shows the thermal images taken of the EVB board at maximum input power.

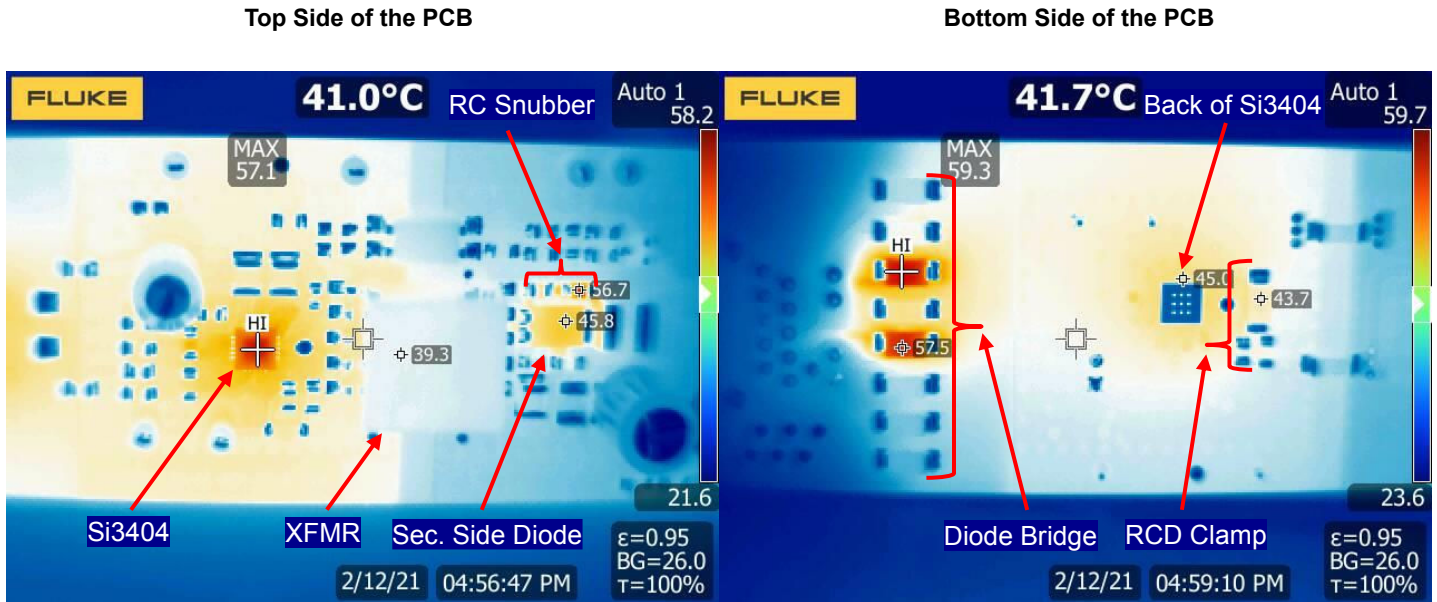

Figure 5.4. Thermal Measurements of the Si3404-ISO-FB EVB, 12 V, Class 3 PD

The following table lists the temperatures of the notable components across the board.

Table 5.1. Component Temperatures at Full Load

Component	Temperature ¹
Si3404 – U1	57.1 °C
Flyback Transformer – T1	39.3 °C
Secondary Side Diode – D1	45.8 °C
Secondary Side RC Snubber – C3–R4	56.7 °C
Diode Bridge – D5–D8, D10–D13	59.3 °C
Primary Side RCD Clamp – R3-C2-D3	43.7 °C
Note:	
1. The ambient temperature was 26 °C during the thermal measurements.	

5.4 Sifos PoE Compatibility Test Results

The PDA-604A Powered Device Analyzer is a single-box comprehensive solution for testing IEEE 802.3at and IEEE 802.3bt PoE Powered Devices (PDs). The Si3404-ISO-FB 12 V EVB board has been successfully tested with the PDA-604A Powered Device Analyzer from Sifos Technologies.

Unlike the Si3406x family, the Si3404 does not incorporate the MPS feature. To prevent PSE shutdown, a minimal 50R load was applied to the Si3404-ISO-FB 12 V EVB's output during the Sifos tests.

See 11. [Complete 12 V Si3404 Isolated Flyback Sifos Compatibility Test Reports](#) for more information.

5.5 Adjustable EVB Current Limit

For additional safety, the Si3404 has an adjustable EVB current limit feature.

The Si3404 controller measures the voltage on the R_{SENSE} resistor (R8) through the ISNS pin. Care must be taken that this voltage goes below V_{SS} . When the voltage on R8 is $V_{ISNS} = -270$ mV (referenced to V_{SS}), the internal current limit circuit restarts the PD to protect the application.

The EVB current limit for this Class 3 application can be calculated with the following formula:

$$R_{SENSE} = 0.62\Omega$$

$$I_{LIMIT} = \frac{270mV}{0.62\Omega} = 435mA$$

Equation 5.1. EVB Class 3 Current Limit

5.6 Feedback Loop Phase and Gain Measurement Results (Bode Plots)

The Si3404 device integrates a current-mode-controlled switching mode power supply controller circuit. Therefore, the application is a closed-loop system. To guarantee stable output voltage of the power supply and to reduce the influence of the input voltage variations and load changes on the output voltage, the feedback loop should be stable.

To verify the stability of the loop, the gain and phase of the loop has been measured.

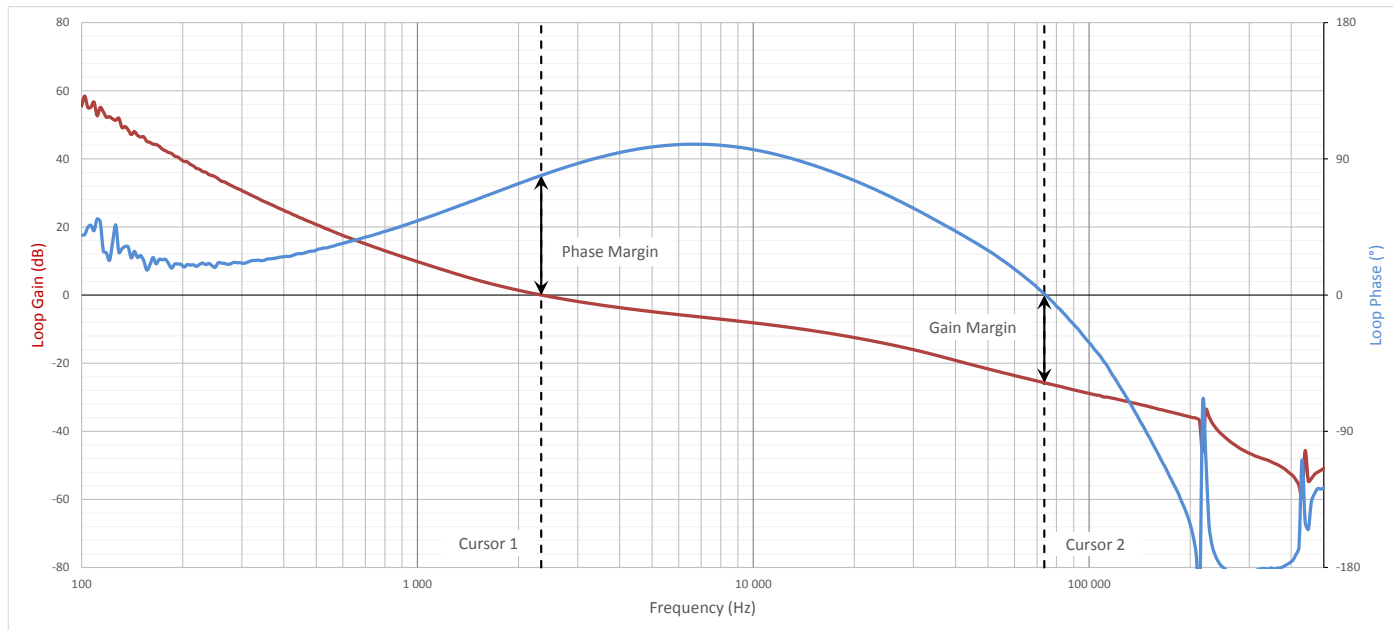

Figure 5.5. Si3404-ISO-FB EVB, 12 V, Class 3 PD Feedback Loop Measurement Results at Light Load

Table 5.2. Measured Loop Gain and Phase Margin at Light Load

	Frequency	Gain	Phase
Cursor 1 (Phase Margin)	2.34 kHz	0 dB	79.10 °
Cursor 2 (Gain Margin)	74.24 kHz	-25.86 dB	0 °

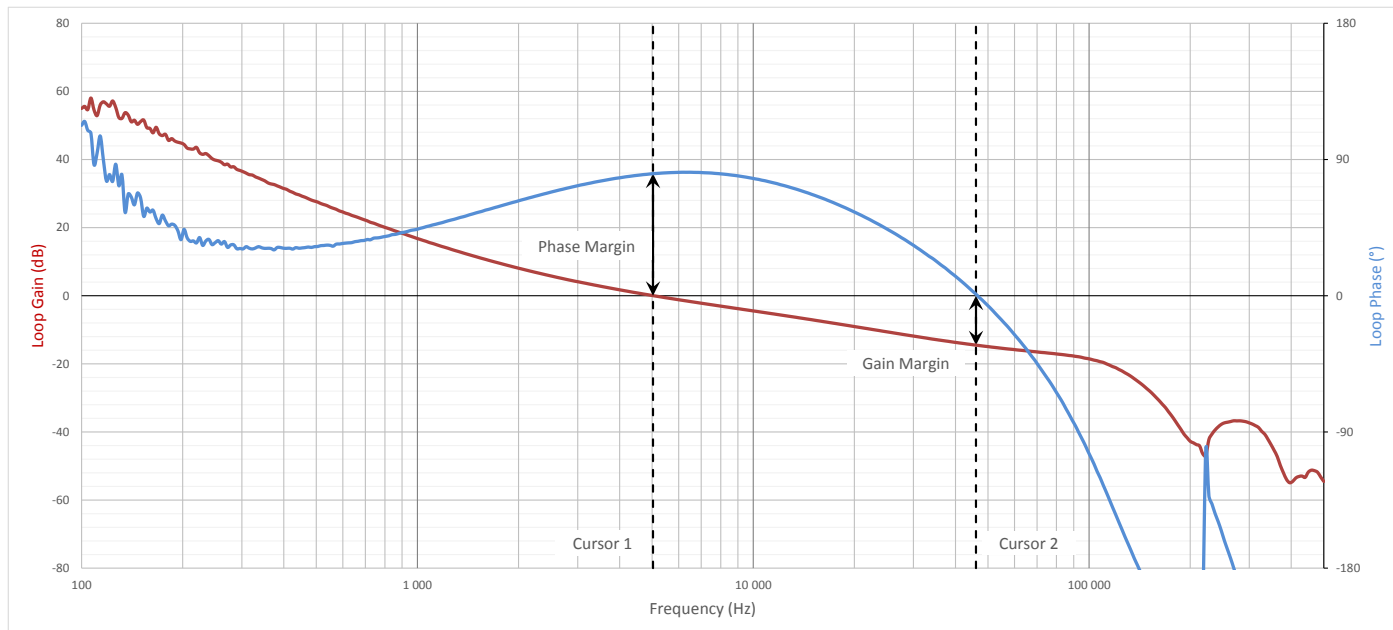

Figure 5.6. Si3404-ISO-FB EVB, 12 V, Class 3 PD Feedback Loop Measurement Results at Full Load

Table 5.3. Measured Loop Gain and Phase Margin at Full Load

	Frequency	Gain	Phase
Cursor 1 (Phase Margin)	5.05 kHz	0 dB	80.65 °
Cursor 2 (Gain Margin)	46.54 kHz	-14.57 dB	0 °

The following table sums up the circumstances of the feedback loop measurements.

Table 5.4. Feedback Loop Measurements Circumstances

Measurement Name	Input Voltage	Output Load
Feedback Loop Measurement at Light Load	50 V	100 R
Feedback Loop Measurement at Full Load	50 V	11 R

5.7 Load Step Transient Measurement Results

The output of the Si3404-ISO-FB EVB board has been tested with a load step function to verify the converter's output dynamic response.

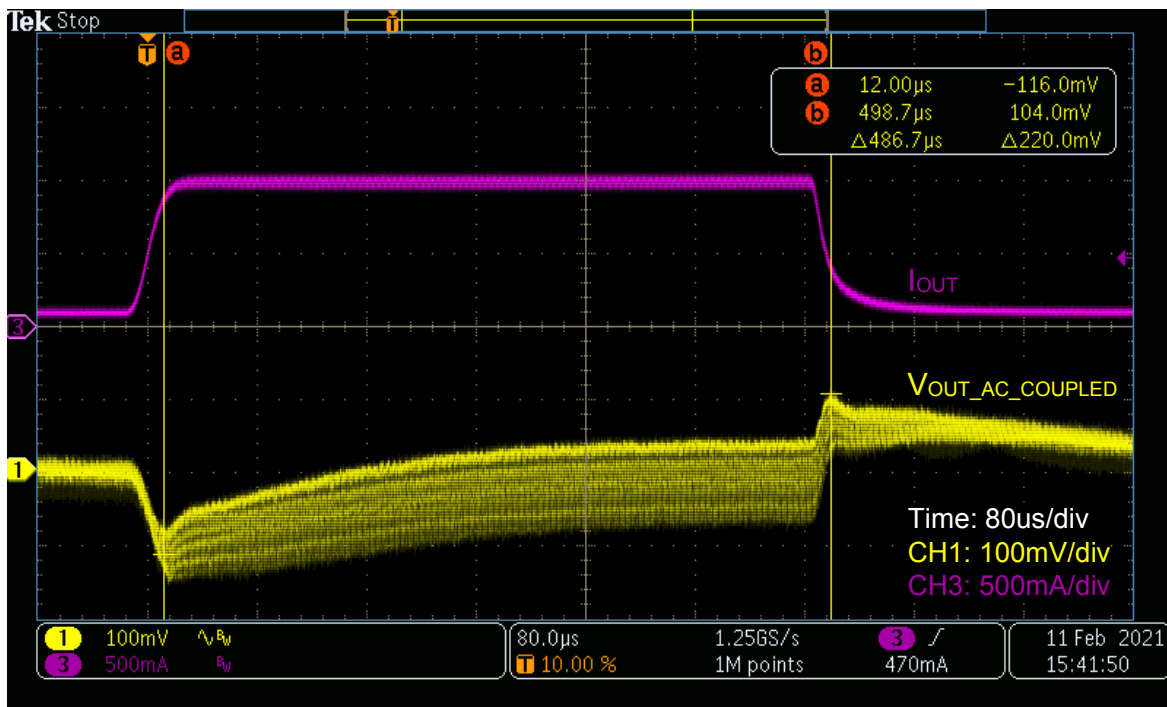

Figure 5.7. Si3404-ISO-FB EVB, 12 V, Class 3 PD Output Load Step Transient Test

The following table sums up the results of the load step measurement.

Table 5.5. Output Load Step Transient Results

	From (Output Current)	To (Output Current)	Slew Rate (Output Current)	V _{OUT} Change
Stepping up the load	0.1 A	1 A	2500 mA/μs	12 V – 116 mV
Stepping down the load	1 A	0.1 A	2500 mA/μs	12 V + 104 mV

5.8 Output Voltage Ripple

The Si3404-ISO-FB EVB output voltage ripple has been measured in both no load and heavy load conditions.

No-Load V_{OUT} Ripple = 12.1 mV

Heavy-Load V_{OUT} Ripple = 123 mV

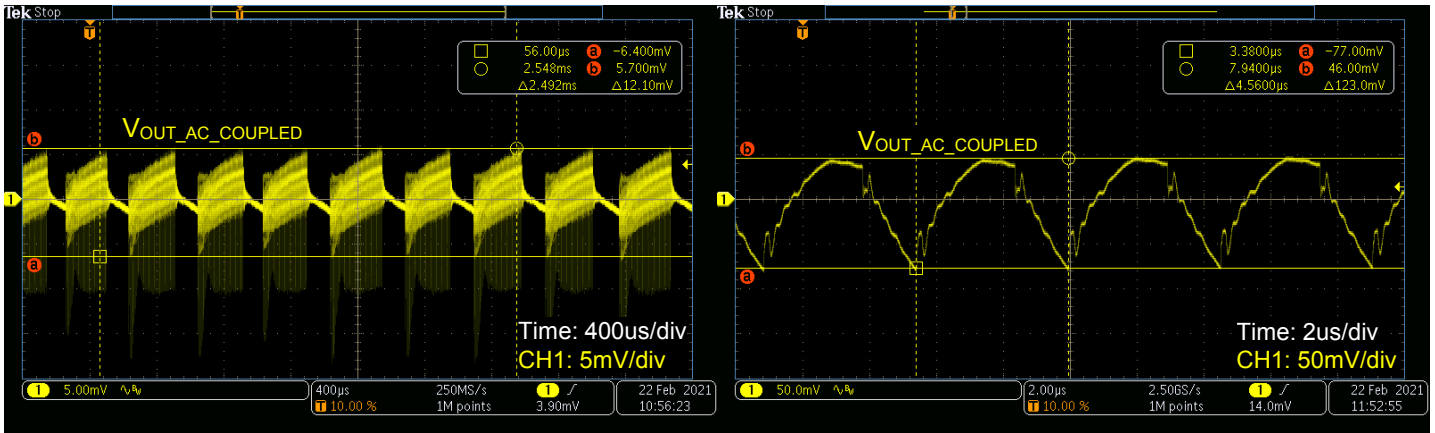

Figure 5.8. Si3404-ISO-FB EVB, 12 V, Class 3 Output Voltage Ripple No Load (Left) and Heavy Load (Right) Conditions

5.9 Soft-Start Protection

The Si3404 device has an integrated dynamic soft-start protection mechanism to avoid stressing the components by the sudden current or voltage changes associated with the initial charging of the output capacitors.

The Si3404 intelligent adaptive soft-start mechanism does not require any external component to install. The controller continuously measures the input current of the PD and dynamically adjusts the internal I_{PEAK} limit during soft-start, thus adjusting the output voltage ramp-up time as a function of the attached load.

The controller allows the output voltage to rise faster in no load (or light load) conditions. With a heavy load at the output, the controller slows down the output voltage ramp to avoid exceeding the desired regulated output voltage value.

No-Load Soft-Start $t_{RISE} = 12.8$ ms

Heavy-Load Soft-Start $t_{RISE} = 38.8$ ms

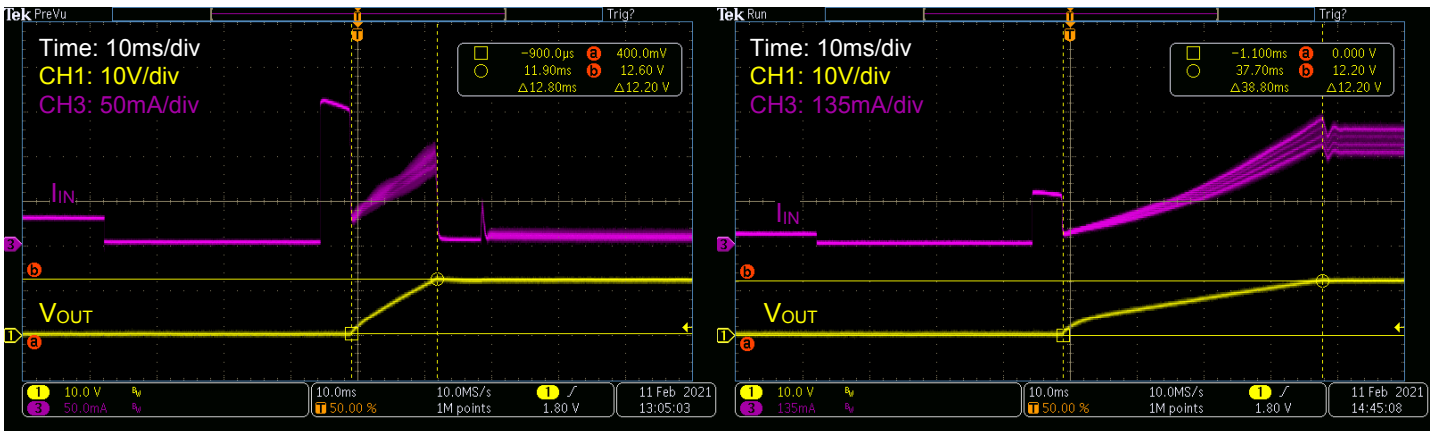

Figure 5.9. Si3404-ISO-FB EVB, 12 V, Class 3 Output Voltage Soft-Start at Low Load (Left) and Heavy Load (Right) Conditions

5.10 Output Short Protection

The Si3404 device has an integrated output short protection mechanism, which protects the IC itself and the surrounding external components from overheating in the case of electrical short on the output.

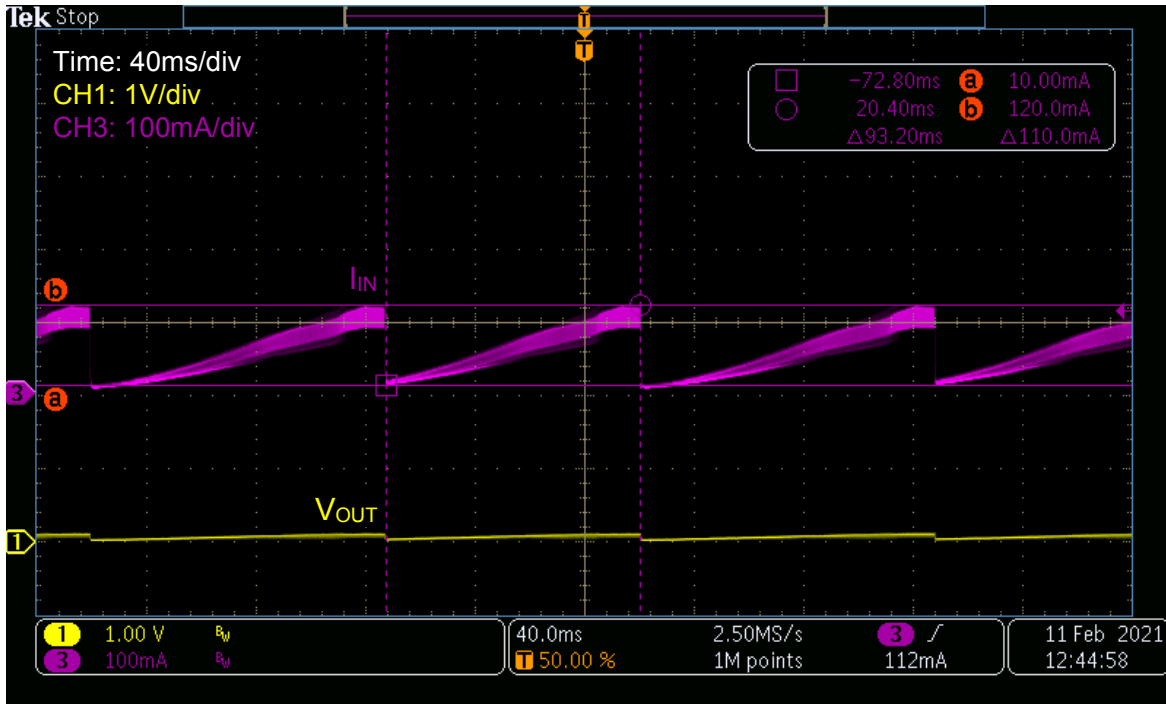

Figure 5.10. Si3404-ISO-FB EVB, 12 V, Class 3 Output Short Circuit Protection

5.11 Pulse Skipping at No-Load Condition

The Si3404 device has an integrated pulse skipping mechanism to ensure ultra-low power consumption under light load conditions.

As the output load decreases, the controller starts to reduce the pulse-width of the PWM signal (switcher ON time). At some point, even the minimum width pulse will provide higher energy than the application requires, which could result in a loss of voltage regulation.

When the controller detects a light load condition (which requires less ON time than the minimum pulse width), the controller enters into pulse-skipping mode. This mode is shown in the following figure, which depicts the switching node of the integrated switching FET at a no-load condition.

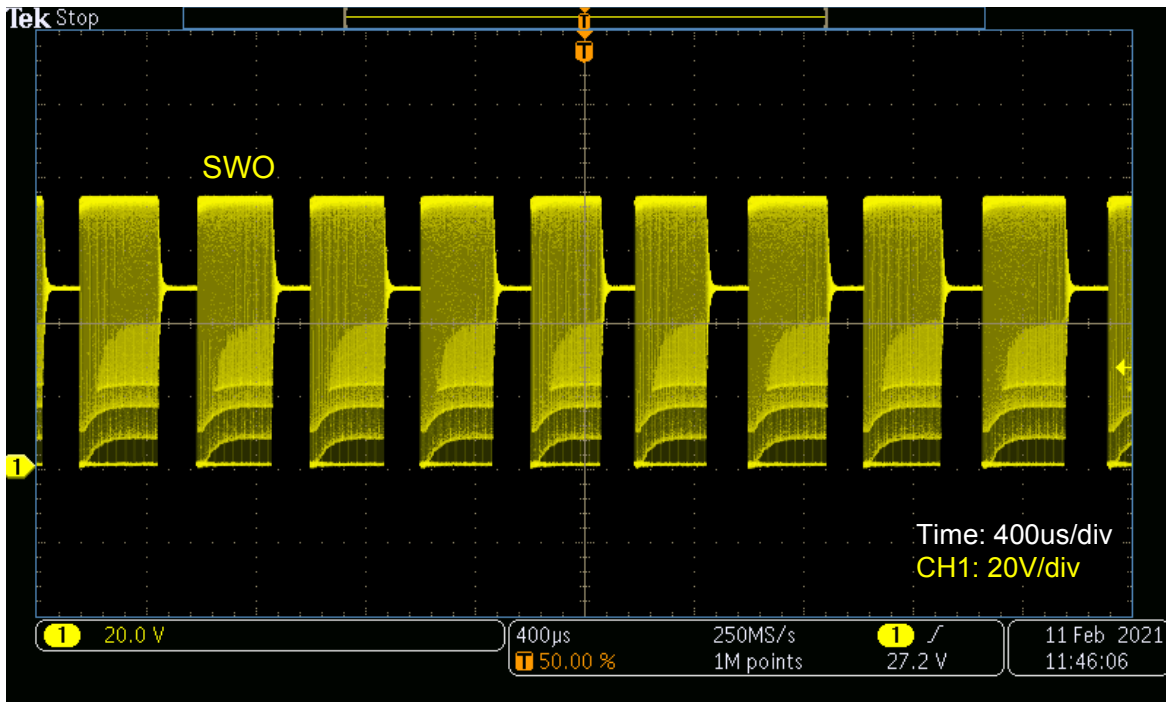

Figure 5.11. Si3404-ISO-FB EVB, 12 V, Class 3 Pulse Skipping at No-load Condition: SWO Waveform

5.12 Discontinuous (DCM) and Continuous (CCM) Conduction Modes

At low load, the converter works in discontinuous conduction mode (DCM). At heavy load, the converter runs in continuous conduction mode (CCM). At low load, the SWO voltage waveform has a ringing waveform, which is typical for DCM operation.

Low-Load, DCM

Heavy-Load, CCM

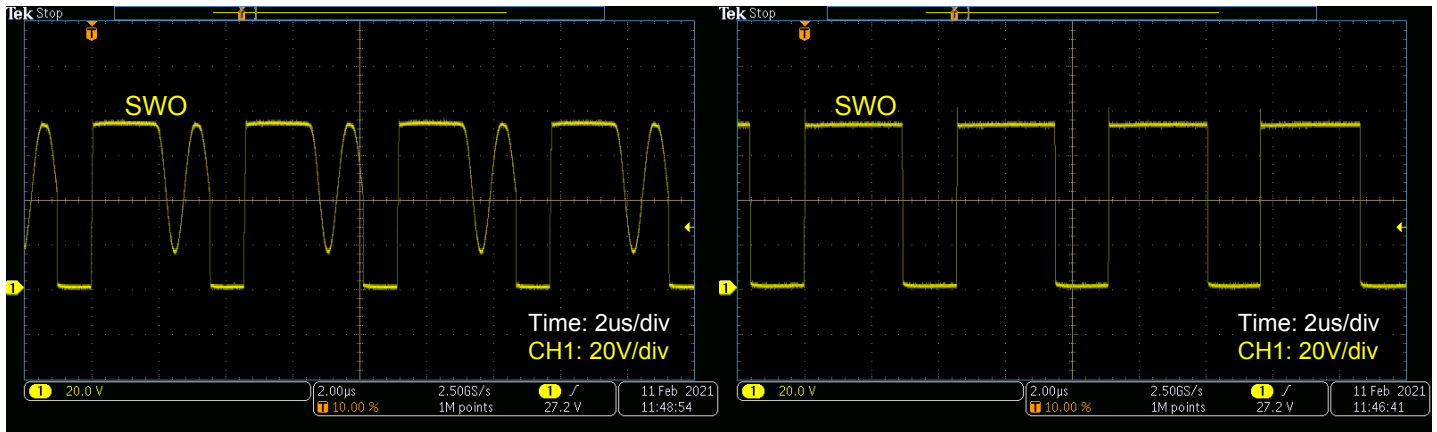

Figure 5.12. Si3404-ISO-FB EVB, 12 V, Class 3: SWO Waveform in Discontinuous Conduction Mode (DCM) at Low Load (Left), and in Continuous Conduction Mode (CCM) at Heavy Load (Right)

Similar voltage waveforms can be observed on the secondary side diode, D1. The voltage levels on the secondary side diode, D1, are much lower due to the transformer turns ratio; however, the discontinuous and continuous conduction mode characteristics are still present.

Low-Load, DCM

Heavy-Load, CCM

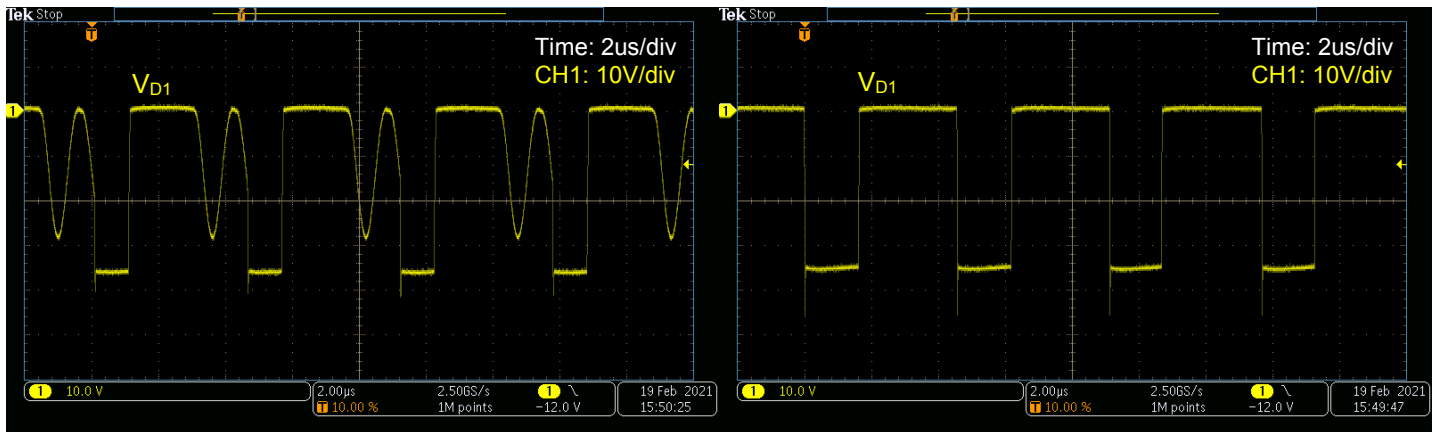

Figure 5.13. Si3404-ISO-FB EVB, 12 V, Class 3: Secondary Side Diode Voltage Waveform in Discontinuous Conduction Mode (DCM) at Low Load (Left), and in Continuous Conduction Mode (CCM) at Heavy Load (Right)

5.13 Radiated Emissions Measurement Results

Radiated emissions of the Si3404-ISO-FB, 12 V, Class 3 EVB board have been measured with 50 V input voltage and a full load connected to the output. The input power is 15 W in this case.

As shown below, the Si3404-ISO-FB, 12 V, Class 3 EVB is fully compliant with the international EN 55032 Class B emissions standard.

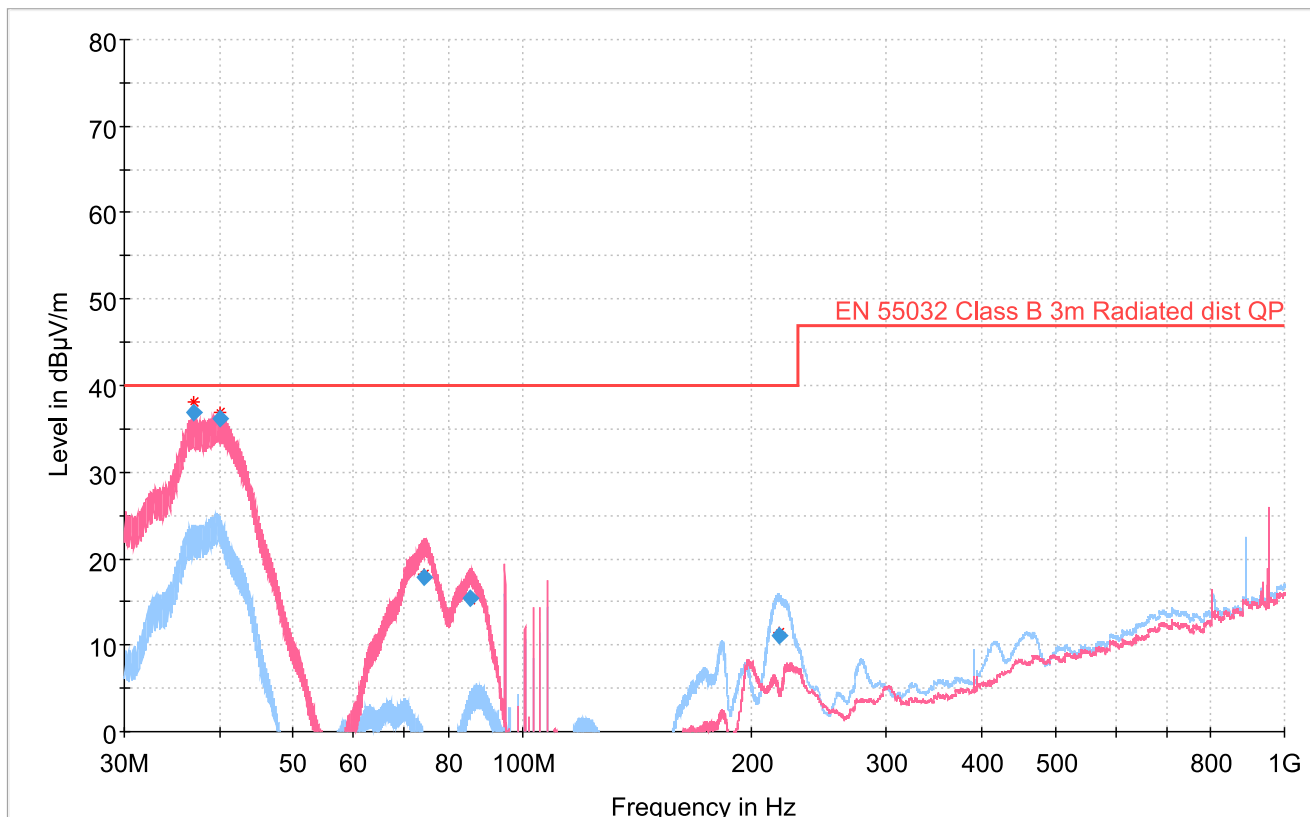

Figure 5.14. Si3404-ISO-FB EVB Radiated Emissions Measurements Results; 50 V Input, 12 V Output, 15 W Input Power

Table 5.6. Notable Peaks on The Radiated Emissions Chart

Frequency	Quasi Peak	Limit	Margin	Polarization
35.99 MHz	36.81 dBµV/m	40 dBµV/m	3.19 dB	Vertical
40.08 MHz	36.22 dBµV/m	40 dBµV/m	3.78 dB	Vertical
74.19 MHz	17.84 dBµV/m	40 dBµV/m	22.16 dB	Vertical
85.26 MHz	15.39 dBµV/m	40 dBµV/m	24.61 dB	Vertical
216.93 MHz	11.13 dBµV/m	40 dBµV/m	28.87 dB	Horizontal

The EVB is measured at full load with peak detection in both vertical and horizontal polarizations. This is a relatively fast process that produces a red curve (vertical polarization) and a blue curve (horizontal polarization).

Next, specific frequencies are selected (red stars) for quasi-peak measurements. The board is measured again at those specific frequencies with a quasi-peak detector, which is a very slow but accurate measurement. The results of this quasi-peak detector measurement are the blue rhombuses.

The blue rhombuses represent the final result of the measurement process. To have passing results, the blue rhombuses should be below the highlighted EN 55032 Class B limit.

5.14 Conducted Emissions Measurement Results

The Si3404-ISO-FB, 12 V, Class 3 EVB board's conducted emissions have been measured by two different measurement methods to comply with the international EN 55032 standard. The EVB is supplied and measured on its PoE input port as shown in the following figure.

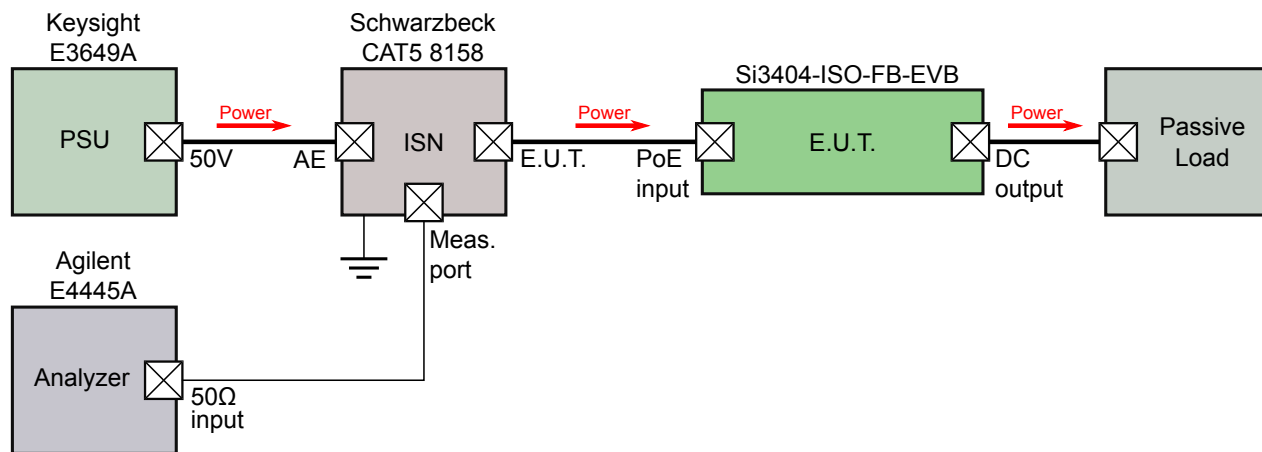

Figure 5.15. Conducted EMI Measurement Setup

The detector in the spectrum analyzer is set to:

- Peak detector and
- Average detector

Both results are shown in the following figure:

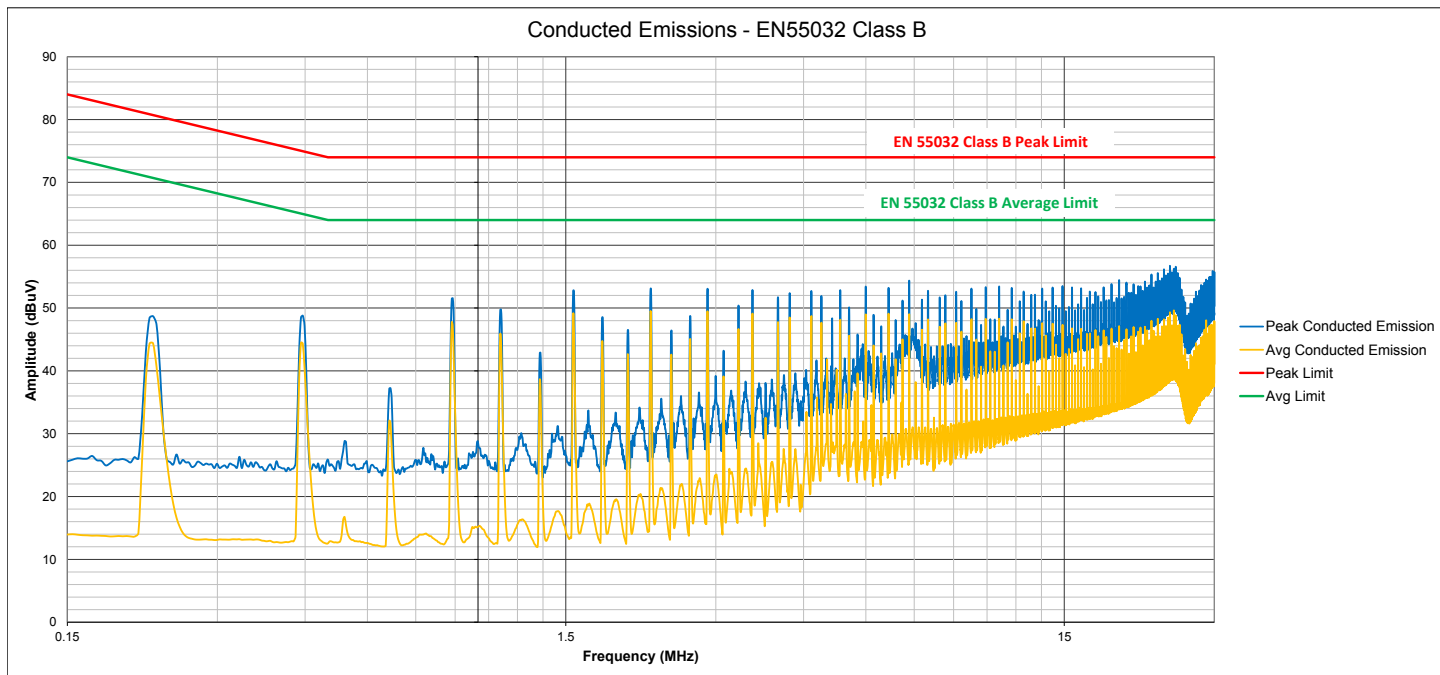

Figure 5.16. Si3404-ISO-FB EVB Conducted Emissions Measurements Results; 50 V Input, 12 V Output, 15 W Input Power

5.15 Bill of Materials

The following table is the BOM listing for the standard 12 V output evaluation board with option PoE Class 3.

Table 5.7. Si3404 Isolated Flyback 12 V Bill of Materials

Reference	Quantity	Description	Manufacturer	ManufacturerPN
C1, C28	2	Capacitor, 1 nF, 3000 V, ±10%, X7R, 1808	Venkel	C1808X7R302-102K
C10	1	Capacitor, 330 µF, 16 V, ±20%, AL, 8X11.5MM, PTH	Panasonic	ECA-1CM331
C14	1	Capacitor, 0.33 µF, 50 V, ±10%, X7R, 0805	Venkel	C0805X7R500-334K
C15	1	Capacitor, 1 µF, 50 V, ±10%, X7R, 0805	Samsung	CL21B105KBFNNNE
C2	1	Capacitor, 0.01 µF, 100 V, ±10%, X7R, 0805	Venkel	C0805X7R101-103K
C20	1	Capacitor, 0.1 µF, 100 V, ±10%, X7R, 0805	Venkel	C0805X7R101-104K
C21	1	Capacitor, 0.1 µF, 16 V, ±10%, X7R, 0805	Venkel	C0805X7R160-104K
C26	1	Capacitor, 1 nF, 50 V, ±1%, C0G, 0805	Venkel	C0805C0G500-102F
C3	1	Capacitor, 680pF, 100 V, ±1%, C0G, 0805	Venkel	C0805C0G101-681FNP
C4	1	Capacitor, 12 µF, 100 V, ±20%, AL, 6.3X11.2MM	Panasonic	EEUFC2A120
C5, C6	2	Capacitor, 1 µF, 100 V, ±10%, X7R, 1210	Venkel	C1210X7R101-105K
C7	1	Capacitor, 0.01 µF, 100 V, ±10%, X7R, 0603	Venkel	C0603X7R101-103K
C8	1	Capacitor, 1 µF, 25 V, ±10%, X5R, 0603	Venkel	C0603X5R250-105K
C9	1	Capacitor, 47 µF, 16 V, ±20%, X5R, 1210	Venkel	C1210X5R160-476MNE
D1	1	Diode, Schottky, 100 V, 5 A, Power-DI-5	Diodes Inc.	SDT5H100P5-7
D2	1	LED, Green, 0805	LITE_ON INC	LTST-C170GKT
D3, D5, D6, D7, D8, D10, D11, D12, D13	9	Diode, Single, 100 V, 1.0 A, SMA	Fairchild	S1B
D4	1	Diode, Single, 100 V, 300 mA, SOD123	Diodes Inc.	1N4148W-7-F
J1, J3	2	Connector, Banana Jack, Threaded uninsulated	ABBATRON HH SMITH	101
J2	1	Connector, RJ-45, Magjack, 1 Port PoE	Bel	SI-52003-F
L1, L3	2	Ferrite Bead, 700 Ω @150 MHz, 0805	Würth	742792040

Reference	Quantity	Description	Manufacturer	ManufacturerPN
R10	1	Resistor, 4.7 k Ω , 1/8 W, \pm 1%, Thick Film, 0805	Venkel	CR0805-8W-4701F
R11	1	Resistor, 825 Ω , 1/8 W, \pm 1%, Thick Film, 0805	Venkel	CR0805-8W-8250F
R12	1	Resistor, 105 k Ω , 1/8 W, \pm 1%, Thick Film, 0805	Yageo	RC0805FR-07105KL
R14	1	Resistor, 88.7 k Ω , 1/8 W, \pm 1%, Thick Film, 0805	Vishay	CRCW080588K7FKEA
R15	1	Resistor, 24.3 k Ω , 1/8 W, \pm 1%, Thick Film, 0805	vishay	CRCW080524K3FKEA
R17	1	Resistor, 48.7 Ω , 1/8W, \pm 1%, Thick Film, 0805	vishay	CRCW080548R7FKTA
R18	1	Resistor, 12.1 k Ω , 1/10W, \pm 1%, Thick Film, 0805	Venkel	CR0805-10W-1212F
R2	1	Resistor, 0 Ω , 6 A, Thick Film, 0805	Vishay Dale	CRCW08050000Z0EAHP
R3	1	Resistor, 130 k Ω , 1/10W, \pm 5%, Thick Film, 0805	Venkel	CR0805-10W-134J
R4	1	Resistor, 18 Ω , 1/10 W, \pm 1%, Thick Film, 0805	Venkel	CR0805-10W-18R0F
R5	1	Resistor, 3.24 k Ω , 1/10 W, \pm 1%, Thick Film, 0805	Venkel	CR0805-10W-3241F
R6, R16	2	Resistor, 0 Ω , 2 A, Thick Film, 0805	Venkel	CR0805-10W-000
R7	1	Resistor, 3 Ω , 1/8W, \pm 1%, Thick Film, 0805	Venkel	CR0805-8W-3R00FT
R8	1	Resistor, 0.62 Ω , 1/8W, \pm 1%, Thick Film, 0805	Yageo	RL0805FR-070R62L
R9	1	Resistor, 10 Ω , 1/10W, \pm 1%, Thick Film, 0805	Venkel	CR0805-10W-10R0F
T1	1	Transformer, Flyback, PoE, 127 μ H, 15W, Aux winding, SMT	Würth Elektronik	7491199112
TP1, TP2, TP8, TP10, TP15, TP16	6	Testpoint, Black, 0.050" Loop, PTH	Keystone	5001
U1	1		Skyworks	Si3404-A-GM
U2	1	Photocoupler, 5000 Vrms Isolation, 4-PIN SMD	Vishay	FOD817A3SD
U3	1	IC, ADJ PREC SHUNT REG LV, 1.24-16V, SOT23-3	ON Semi	TLV431ASN1T1G
Not Installed Components				
C11, C12, C13	3	Capacitor, 100 μ F, 6.3V, \pm 10%, X5R, 1210	Venkel	C1210X5R6R3-107K
C16, C17, C18, C19, C22, C23, C24, C25	8	Capacitor, 1 nF, 100 V, \pm 10%, X7R, 0603	Venkel	C0603X7R101-102K
C27	1	Capacitor, 0.01 μ F, 100V, \pm 10%, X7R, 0805	Venkel	C0805X7R101-103K

Reference	Quantity	Description	Manufacturer	ManufacturerPN
D9	1	Diode, TVS, Unidirectional, 58 V, 400 W	Littelfuse	SMAJ58A
L2	1	Inductor, Power, Shielded, 0.16 μ H, 31 A, SMD	Coilcraft	XAL5030-161ME
R1	1	Resistor, 1 k Ω , 1/10 W, \pm 1%, Thick Film, 0805	Venkel	CR0805-10W-1001F
R13	1	Resistor, 0 Ω , 2 A, Thick Film, 0805	Venkel	CR0805-10W-000
TP3, TP4, TP5, TP6, TP7, TP9, TP11, TP12, TP13, TP14	10	Testpoint, Black, 0.050" Loop, PTH	Keystone	5001

6. Tunable Switching Frequency

The switching frequency of the oscillator is selected by choosing an external resistor (R_{FREQ}) connected between the R_{FREQ} and VPOS pins. The following figure will aid in choosing the R_{FREQ} value to achieve the desired switching frequency.

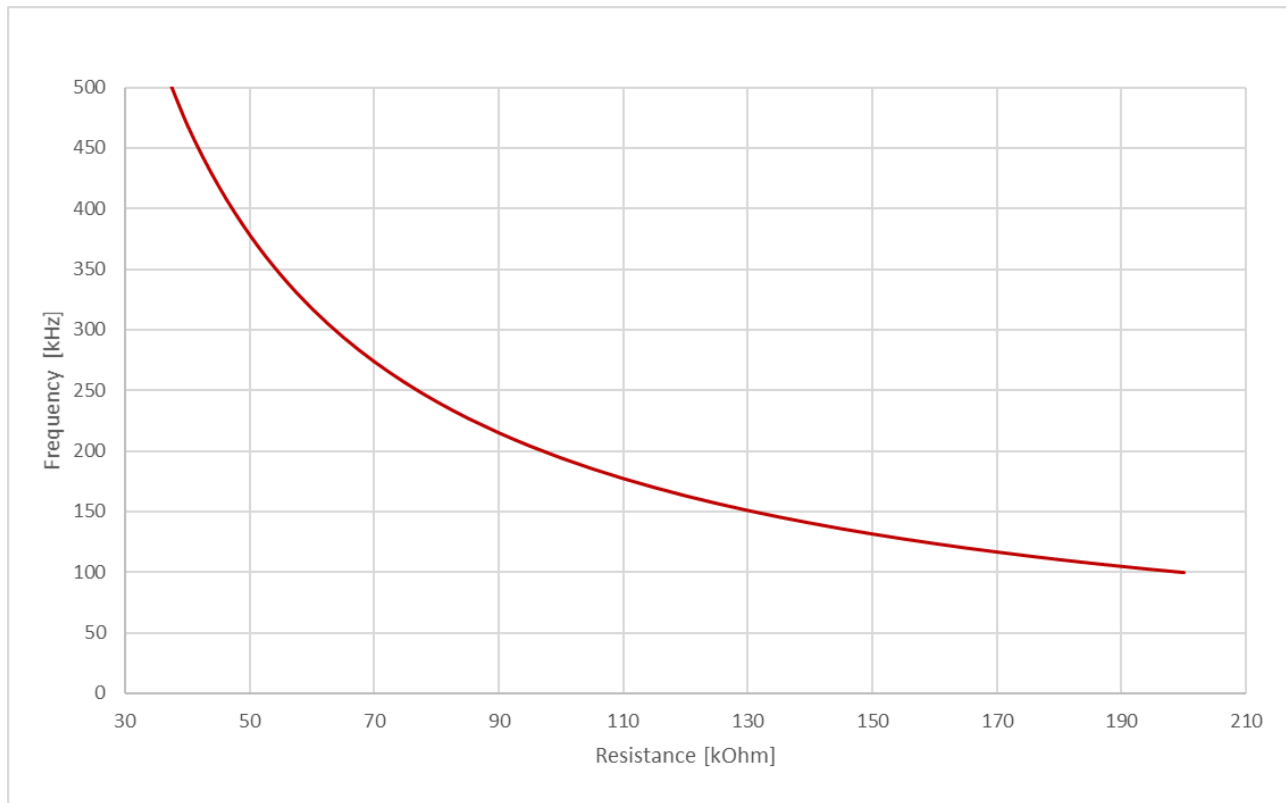

Figure 6.1. Switching Frequency vs R_{FREQ}

The selected switching frequency for these applications is 220 kHz, which is achieved by setting the R_{FREQ} resistor to 88.7 k Ω .

7. Board Layout

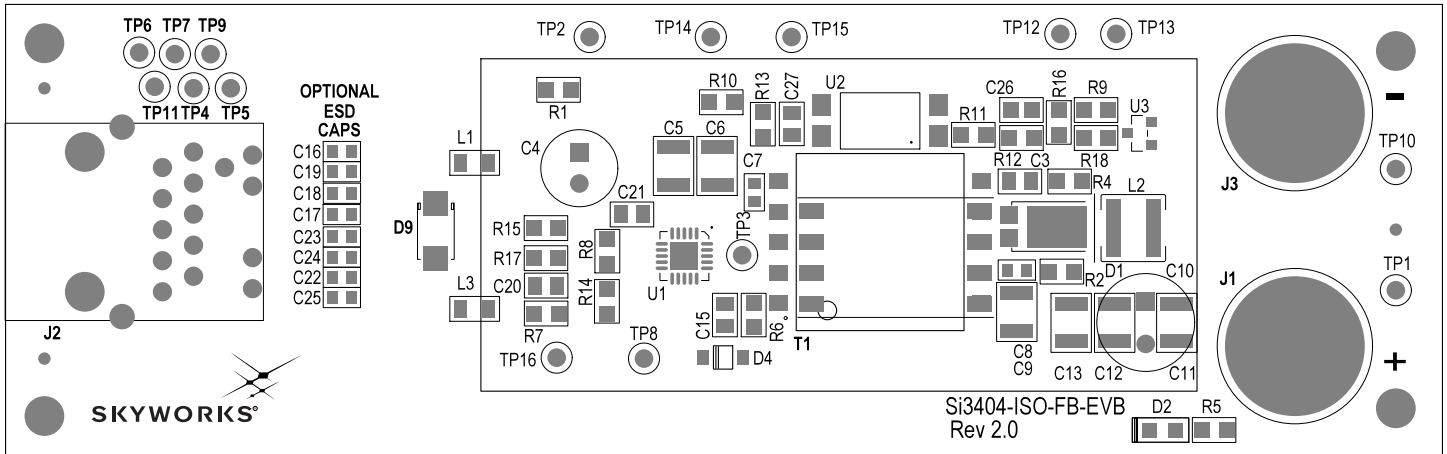

Figure 7.1. Top Silkscreen

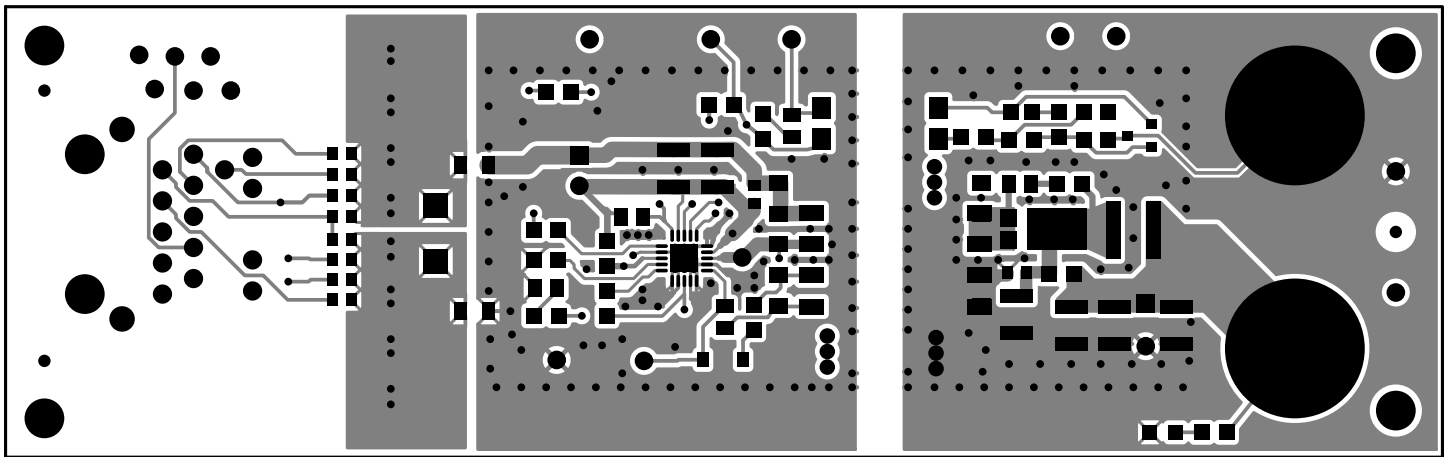

Figure 7.2. Top Layer

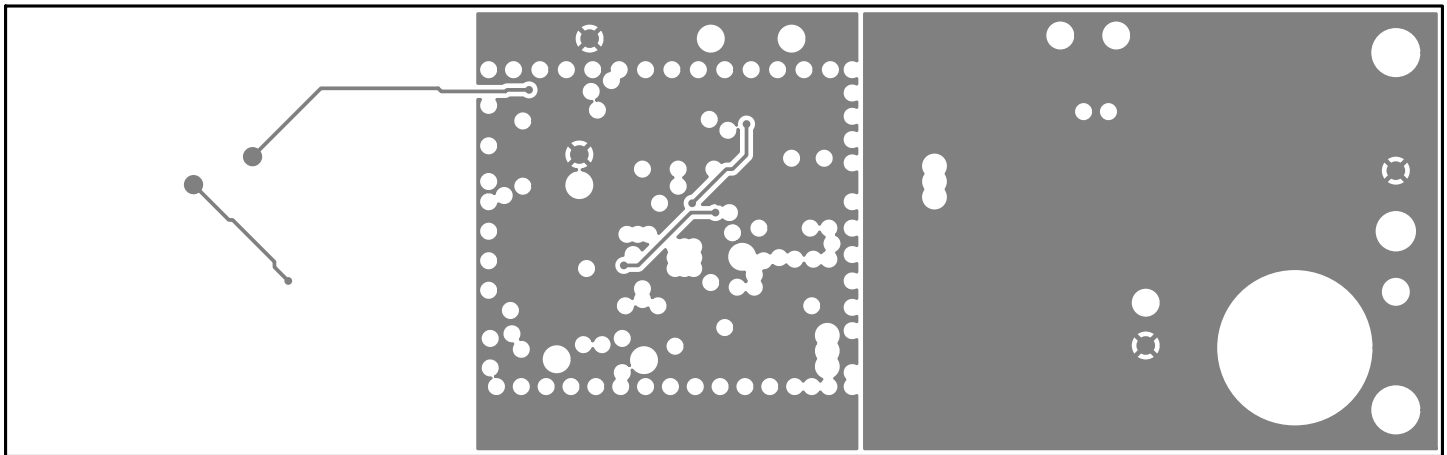

Figure 7.3. Internal 1 (Layer 2)

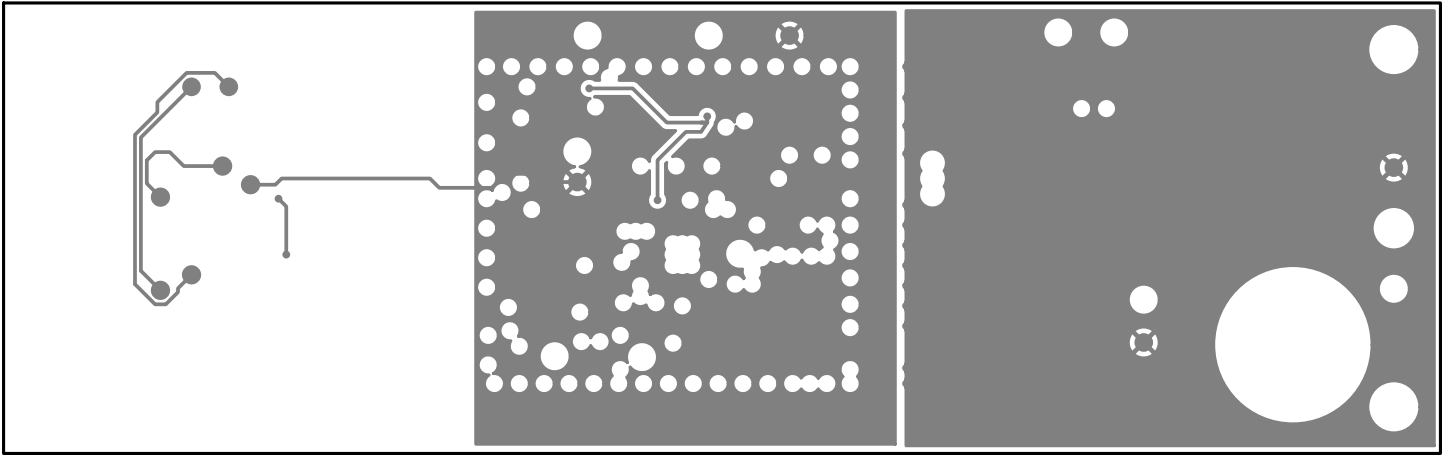

Figure 7.4. Internal 2 (Layer 3)

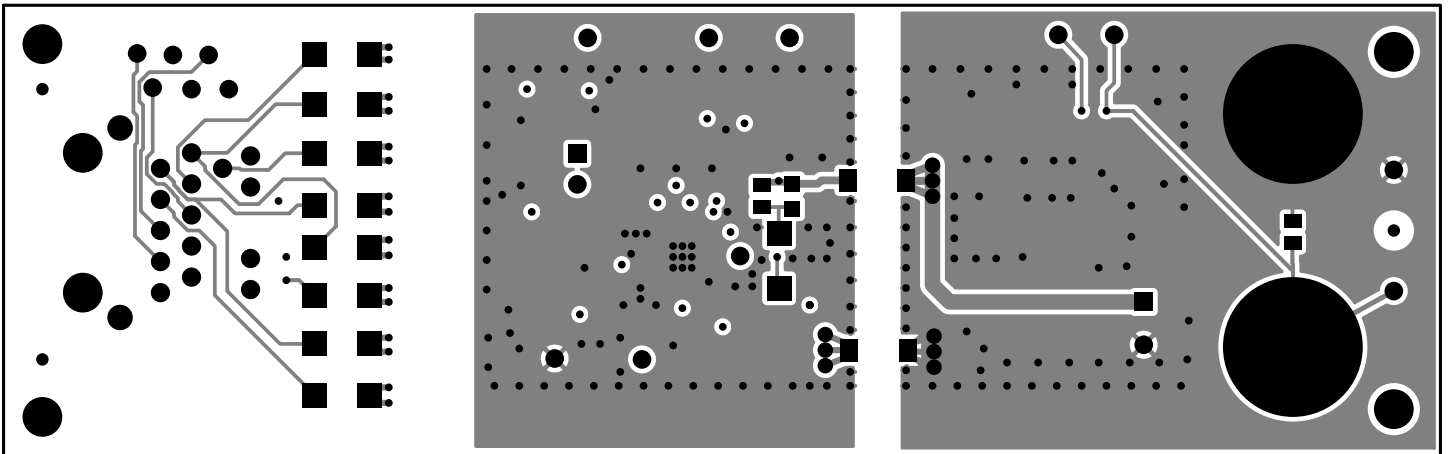

Figure 7.5. Bottom Layer

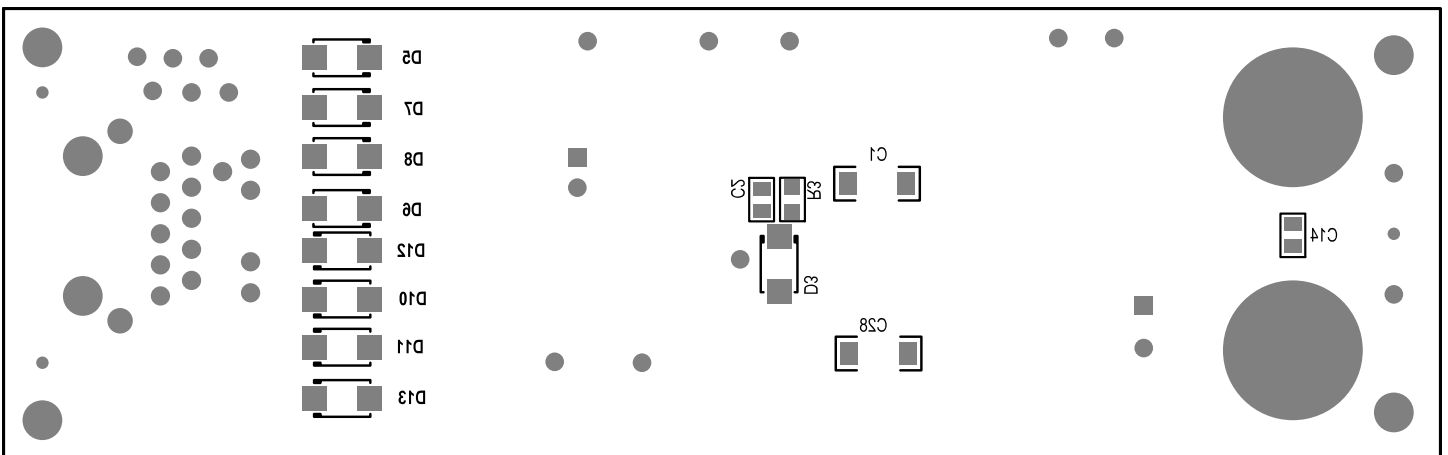

Figure 7.6. Bottom Silkscreen

8. Design and Layout Checklist

The complete EVB design databases for the four configurations are located at <https://www.skyworksinc.com/en/products/power-powered-devices>. Skyworks strongly recommends using these EVB schematics and layout files as a starting point to ensure robust performance and avoid common mistakes in the schematic capture and PCB layout processes.

Below is a recommended design checklist that can assist in trouble-free development of robust PD designs.

Refer also to the [Si3404 Data Sheet](#) and "[AN1130: Si3404/06x PoE-PD Controller Design Guide](#)" when using the following checklist.

1. Design Planning Checklist:

- a. Determine if your design requires an isolated or non-isolated topology. For more information, see [AN1130: Si3404/06x PoE-PD Controller Design Guide](#).
- b. Skyworks strongly recommends using the EVB schematics and layout files as a starting point as you begin integrating the Si3404-ISO-FB into your system design process.
- c. Determine your load's power requirements (i.e., V_{OUT} and I_{OUT} consumed by the PD, including the typical expected transient surge conditions). In general, to achieve the highest overall efficiency performance of the Si3404-ISO-FB, choose the highest output voltage option used in your PD and then post regulate to the lower supply rails, if necessary.
- d. Based on your required PD power level, select the appropriate class resistor RCLASS value by referring to [AN1130: Si3404/06x PoE-PD Controller Design Guide](#).

2. General Design Checklist:

- a. Non-standard PoE injectors turns on the PD without detection and classification phases. In most cases, dV/dt is not controlled and could violate IEEE requirements. To ensure robustness with those injectors, please include a 3 Ω resistor in series with the 100 nF / 100 V detection capacitor.
- b. Skyworks recommends the inclusion of a minimum load (250 mW) to avoid the PSE port being disconnected by the PSE. If your load is not at least 250 mW, add a resistor load to dissipate at least 250 mW.

3. Layout Guidelines:

- a. Make sure the VNEG pin of the Si3404 is connected to the backside of the QFN package with an adequate thermal plane.
- b. Keep the trace length from SWO to VSS as short as possible. Make all of the power (high current) traces as short, direct, and thick as possible. It is a good practice on a standard PCB board to make the traces an absolute minimum of 15 mils (0.381 mm) per ampere.
- c. Usually, one standard via handles 200 mA of current. If the trace needs to conduct a significant amount of current from one plane to the other, use multiple vias.
- d. Keep the circular area of the loop from the Switcher FET output to the inductor and returning from the input filter capacitors (C5–C7) to VSS as small a diameter as possible. Also, minimize the circular area of the loop from the output of the inductor to the Schottky diode and returning through the output filter capacitor back to the inductor as small as possible. If possible, keep the direction of current flow in these two loops the same.
- e. Keep the high-power traces as short as possible.
- f. Keep the feedback and loop stability components as far from the inductor and noisy power traces as possible.
- g. If the outputs have a ground plane or positive output plane, do not connect the high current carrying components and the filter capacitors through the plane. Connect them together, and then connect to the plane at a single point.

To help ensure first-pass success, contact our customer support by submitting a help ticket and uploading your schematics and layout files for review.

9. Complete 3.3 V Si3404 Isolated Flyback Sifos Compatibility Test Reports

Table 9.1. Si3404-ISO-FB EVB, 3.3 V, Class 3 PD Sifos PoE Compatibility Test Results, PSE Emulation: Alt A MDI

Detection and Classification	PSE Emulation		Pairs	A	Polarity	MDI	Det_Cycles	3
Parameter Cycle	1	Units	Min.	Max.	Average	Low Lim.	High Lim.	P/F
Rdet	24.35	kΩ	24.35	24.35	24.35	23.70	26.30	P
Rdet_final	24.37	kΩ	24.37	24.37	24.37	23.70	26.30	P
Rdet_unpwr	>99.00	kΩ	99.00	99.00	99.00	<12.00	>45.00	P
Rdet_at_Vmin	24.53	kΩ	24.53	24.53	24.53	23.70	26.30	P
Rdet_at_Vmax	24.50	kΩ	24.50	24.50	24.50	23.70	26.30	P
Rdet_Voffset	1.0	VDC	1.0	1.0	1.0	0.0	1.9	P
Cdet	0.11	μF	0.11	0.11	0.11	0.05	0.12	P
Cdet_final	0.11	μF	0.11	0.11	0.11	0.05	0.12	P
1 Event Classification								
Iclass	28.5	mA	28.5	28.5	28.5	26.0	30.0	P
ClassNum	3		3	3	—	0	4	P
Tclass	0.0005	s	0.0005	0.0005	0.0005	0.0005	0.0050	P
ClassStability	1					1	1	P
Iclass_at_Vmin	28.7	mA	28.7	28.7	28.7	26.0	30.0	P
Iclass_at_Vmax	28.5	mA	28.5	28.5	28.5	26.0	30.0	P
2 Event Classification								
Iclass_event1	28.5	mA	28.5	28.5	28.5	26.0	30.0	P
Iclass_event2	28.5	mA	28.5	28.5	28.5	26.0	30.0	P
MarkI	1.74	mA	1.74	1.74	1.74	0.25	4.00	INFO
ClassNum2	3		3	3	—	0	4	P
Tclass_event1	0.0005	s	0.0005	0.0005	0.0005	0.0005	0.0050	P
Tclass_event2	0.0005	s	0.0005	0.0005	0.0005	0.0005	0.0050	P
ClassStability_event1	1					1	1	P
ClassStability_event2	1					1	1	P
Power-Up / Down								
Parameter Cycle	1	Units	Min.	Max.	Average	Low Lim.	High Lim.	P/F
InrushI_1	160.4	mA	160.4	160.4	160.4	0.0	400.0	P
InrushI_2	-1.0	mA	-1.0	-1.0	-1.0	0.0	400.0	NA
Pmax_Tdelay	-1.0	W	-1.0	-1.0	-1.0	0.0	0.0	NA
Inrush_delayed	0		0	0	—	0	0	P
Von	38.2	VDC	38.2	38.2	38.2	30.0	42.0	P
Voff	33.9	VDC	33.9	33.9	33.9	30.0	42.0	P

Vhyst	4.3	VDC	4.3	4.3	4.3	0.0	12.0	P
BackfeedV	0.1	VDC	0.1	0.1	0.1	0.0	2.8	P
ClassRecover	0		0	0	—	0	0	P
SigRecoverTime	0.0	s	0.0	0.0	0.0	0.0	30.0	P
MDI Powered Type-1	PSE Emulation		On Time	10 s	Off Time	10 s	Vport	48.0
Parameter Cycle	1	Units	Min.	Max.	Average	Low Lim.	High Lim.	P/F
MinI_1	16.0	mA	16.0	16.0	16.0	0.0	299.5	P
MaxI_1	17.5	mA	17.5	17.5	17.5	10.0	299.5	P
Vport_1	48.0	VDC	48.0	48.0	48.0	37.0	57.0	INFO
Ppeak_1	0.84	W	0.84	0.84	0.84	0.0	14.4	P
Pavg_1	0.79	W	0.79	0.79	0.79	0.0	13.0	P
MPSViolation_1	0		0	0	—	0	0	P
TcutWindowViolation_1	0		0	0	—	0	0	P
DutyCycleViolation_1	0		0	0	—	0	0	P

Table 9.2. Si3404-ISO-FB EVB, 3.3 V, Class 3 PD Sifos PoE Compatibility Test Results, PSE Emulation: Alt A MDI-X

Detection and Classification	PSE Emulation		Pairs	A	Polarity	MDI-X	Det_Cycles	3
Parameter Cycle	1	Units	Min.	Max.	Average	Low Lim.	High Lim.	P/F
Rdet	24.33	kΩ	24.33	24.33	24.33	23.70	26.30	P
Rdet_final	24.40	kΩ	24.40	24.40	24.40	23.70	26.30	P
Rdet_unpwr	>99.00	kΩ	99.00	99.00	99.00	<12.00	>45.00	P
Rdet_at_Vmin	24.67	kΩ	24.67	24.67	24.67	23.70	26.30	P
Rdet_at_Vmax	24.60	kΩ	24.60	24.60	24.60	23.70	26.30	P
Rdet_Voffset	1.0	VDC	1.0	1.0	1.0	0.0	1.9	P
Cdet	0.11	μF	0.11	0.11	0.11	0.05	0.12	P
Cdet_final	0.11	μF	0.11	0.11	0.11	0.05	0.12	P
1 Event Classification								
Iclass	28.5	mA	28.5	28.5	28.5	26.0	30.0	P
ClassNum	3		3	3	—	0	4	P
Tclass	0.0005	s	0.0005	0.0005	0.0005	0.0005	0.0050	P
ClassStability	1					1	1	P
Iclass_at_Vmin	28.8	mA	28.8	28.8	28.8	26.0	30.0	P
Iclass_at_Vmax	28.4	mA	28.4	28.4	28.4	26.0	30.0	P
2 Event Classification								
Iclass_event1	28.5	mA	28.5	28.5	28.5	26.0	30.0	P
Iclass_event2	28.5	mA	28.5	28.5	28.5	26.0	30.0	P
MarkI	1.74	mA	1.74	1.74	1.74	0.25	4.00	INFO
ClassNum2	3		3	3	—	0	4	P
Tclass_event1	0.0005	s	0.0005	0.0005	0.0005	0.0005	0.0050	P
Tclass_event2	0.0005	s	0.0005	0.0005	0.0005	0.0005	0.0050	P
ClassStability_event1	1					1	1	P
ClassStability_event2	1					1	1	P
Power-Up / Down								
Parameter Cycle	1	Units	Min.	Max.	Average	Low Lim.	High Lim.	P/F
InrushI_1	160.2	mA	160.2	160.2	160.2	0.0	400.0	P
InrushI_2	-1.0	mA	-1.0	-1.0	-1.0	0.0	400.0	NA
Pmax_Tdelay	-1.0	W	-1.0	-1.0	-1.0	0.0	0.0	NA
Inrush_delayed	0		0	0	—	0	0	P
Von	38.2	VDC	38.2	38.2	38.2	30.0	42.0	P
Voff	34.1	VDC	34.1	34.1	34.1	30.0	42.0	P
Vhyst	4.1	VDC	4.1	4.1	4.1	0.0	12.0	P
BackfeedV	0.0	VDC	0.0	0.0	0.0	0.0	2.8	P

ClassRecover	0		0	0	—	0	0	P
SigRecoverTime	0.0	s	0.0	0.0	0.0	0.0	30.0	P
MDI Powered Type-1	PSE Emulation		On Time	10 s	Off Time	10 s	Vport	48.0
Parameter Cycle	1	Units	Min.	Max.	Average	Low Lim.	High Lim.	P/F
MinI_1	15.9	mA	15.9	15.9	15.9	0.0	298.9	P
MaxI_1	17.7	mA	17.7	17.7	17.7	10.0	298.9	P
Vport_1	48.1	VDC	48.1	48.1	48.1	37.0	57.0	INFO
Ppeak_1	0.85	W	0.85	0.85	0.85	0.0	14.4	P
Pavg_1	0.78	W	0.78	0.78	0.78	0.0	13.0	P
MPSViolation_1	0		0	0	—	0	0	P
TcutWindowViolation_1	0		0	0	—	0	0	P
DutyCycleViolation_1	0		0	0	—	0	0	P

Table 9.3. Si3404-ISO-FB EVB, 3.3 V, Class 3 PD Sifos PoE Compatibility Test Results, PSE Emulation: Alt B MDI

Detection and Classification	PSE Emulation		Pairs	B	Polarity	MDI	Det_Cycles	3
Parameter Cycle	1	Units	Min.	Max.	Average	Low Lim.	High Lim.	P/F
Rdet	24.33	kΩ	24.33	24.33	24.33	23.70	26.30	P
Rdet_final	24.40	kΩ	24.40	24.40	24.40	23.70	26.30	P
Rdet_unpwr	>99.00	kΩ	99.00	99.00	99.00	<12.00	>45.00	P
Rdet_at_Vmin	24.60	kΩ	24.60	24.60	24.60	23.70	26.30	P
Rdet_at_Vmax	24.52	kΩ	24.52	24.52	24.52	23.70	26.30	P
Rdet_Voffset	1.0	VDC	1.0	1.0	1.0	0.0	1.9	P
Cdet	0.11	μF	0.11	0.11	0.11	0.05	0.12	P
Cdet_final	0.11	μF	0.11	0.11	0.11	0.05	0.12	P
1 Event Classification								
Iclass	28.7	mA	28.7	28.7	28.7	26.0	30.0	P
ClassNum	3		3	3	—	0	4	P
Tclass	0.0005	s	0.0005	0.0005	0.0005	0.0005	0.0050	P
ClassStability	1					1	1	P
Iclass_at_Vmin	29.3	mA	29.3	29.3	29.3	26.0	30.0	P
Iclass_at_Vmax	28.6	mA	28.6	28.6	28.6	26.0	30.0	P
2 Event Classification								
Iclass_event1	28.7	mA	28.7	28.7	28.7	26.0	30.0	P
Iclass_event2	28.7	mA	28.7	28.7	28.7	26.0	30.0	P
MarkI	1.81	mA	1.81	1.81	1.81	0.25	4.00	INFO
ClassNum2	3		3	3	—	0	4	P
Tclass_event1	0.0005	s	0.0005	0.0005	0.0005	0.0005	0.0050	P
Tclass_event2	0.0005	s	0.0005	0.0005	0.0005	0.0005	0.0050	P
ClassStability_event1	1					1	1	P
ClassStability_event2	1					1	1	P
Power-Up / Down								
Parameter Cycle	1	Units	Min.	Max.	Average	Low Lim.	High Lim.	P/F
InrushI_1	160.1	mA	160.1	160.1	160.1	0.0	400.0	P
InrushI_2	-1.0	mA	-1.0	-1.0	-1.0	0.0	400.0	NA
Pmax_Tdelay	-1.0	W	-1.0	-1.0	-1.0	0.0	0.0	NA
Inrush_delayed	0		0	0	—	0	0	P
Von	38.2	VDC	38.2	38.2	38.2	30.0	42.0	P
Voff	34.0	VDC	34.0	34.0	34.0	30.0	42.0	P
Vhyst	4.1	VDC	4.1	4.1	4.1	0.0	12.0	P
BackfeedV	0.0	VDC	0.0	0.0	0.0	0.0	2.8	P

ClassRecover	0		0	0	—	0	0	P
SigRecoverTime	0.0	s	0.0	0.0	0.0	0.0	30.0	P
MDI Powered Type-1	PSE Emulation		On Time	10 s	Off Time	10 s	Vport	48.0
Parameter Cycle	1	Units	Min.	Max.	Average	Low Lim.	High Lim.	P/F
MinI_1	15.5	mA	15.5	15.5	15.5	0.0	299.9	P
MaxI_1	17.0	mA	17.0	17.0	17.0	10.0	299.9	P
Vport_1	48.0	VDC	48.0	48.0	48.0	37.0	57.0	INFO
Ppeak_1	0.82	W	0.82	0.82	0.82	0.0	14.4	P
Pavg_1	0.76	W	0.76	0.76	0.76	0.0	13.0	P
MPSViolation_1	0		0	0	—	0	0	P
TcutWindowViolation_1	0		0	0	—	0	0	P
DutyCycleViolation_1	0		0	0	—	0	0	P

Table 9.4. Si3404-ISO-FB EVB, 3.3 V, Class 3 PD Sifos PoE Compatibility Test Results, PSE Emulation: Alt B MDI-X

Detection and Classification	PSE Emulation		Pairs	B	Polarity	MDI-X	Det_Cycles	3
Parameter Cycle	1	Units	Min.	Max.	Average	Low Lim.	High Lim.	P/F
Rdet	24.44	kΩ	24.44	24.44	24.44	23.70	26.30	P
Rdet_final	24.44	kΩ	24.44	24.44	24.44	23.70	26.30	P
Rdet_unpwr	>99.00	kΩ	99.00	99.00	99.00	<12.00	>45.00	P
Rdet_at_Vmin	24.69	kΩ	24.69	24.69	24.69	23.70	26.30	P
Rdet_at_Vmax	24.59	kΩ	24.59	24.59	24.59	23.70	26.30	P
Rdet_Voffset	1.0	VDC	1.0	1.0	1.0	0.0	1.9	P
Cdet	0.11	μF	0.11	0.11	0.11	0.05	0.12	P
Cdet_final	0.11	μF	0.11	0.11	0.11	0.05	0.12	P
1 Event Classification								
Iclass	28.7	mA	28.7	28.7	28.7	26.0	30.0	P
ClassNum	3		3	3	—	0	4	P
Tclass	0.0005	s	0.0005	0.0005	0.0005	0.0005	0.0050	P
ClassStability	1					1	1	P
Iclass_at_Vmin	28.9	mA	28.9	28.9	28.9	26.0	30.0	P
Iclass_at_Vmax	28.5	mA	28.5	28.5	28.5	26.0	30.0	P
2 Event Classification								
Iclass_event1	28.7	mA	28.7	28.7	28.7	26.0	30.0	P
Iclass_event2	28.7	mA	28.7	28.7	28.7	26.0	30.0	P
MarkI	1.82	mA	1.82	1.82	1.82	0.25	4.00	INFO
ClassNum2	3		3	3	—	0	4	P
Tclass_event1	0.0005	s	0.0005	0.0005	0.0005	0.0005	0.0050	P
Tclass_event2	0.0005	s	0.0005	0.0005	0.0005	0.0005	0.0050	P
ClassStability_event1	1					1	1	P
ClassStability_event2	1					1	1	P
Power-Up / Down								
Parameter Cycle	1	Units	Min.	Max.	Average	Low Lim.	High Lim.	P/F
InrushI_1	160.1	mA	160.1	160.1	160.1	0.0	400.0	P
InrushI_2	-1.0	mA	-1.0	-1.0	-1.0	0.0	400.0	NA
Pmax_Tdelay	-1.0	W	-1.0	-1.0	-1.0	0.0	0.0	NA
Inrush_delayed	0		0	0	—	0	0	P
Von	38.2	VDC	38.2	38.2	38.2	30.0	42.0	P
Voff	34.1	VDC	34.1	34.1	34.1	30.0	42.0	P
Vhyst	4.2	VDC	4.2	4.2	4.2	0.0	12.0	P
BackfeedV	0.0	VDC	0.0	0.0	0.0	0.0	2.8	P

ClassRecover	0		0	0	—	0	0	P
SigRecoverTime	0.0	s	0.0	0.0	0.0	0.0	30.0	P
MDI Powered Type-1	PSE Emulation		On Time	10 s	Off Time	10 s	Vport	48.0
Parameter Cycle	1	Units	Min.	Max.	Average	Low Lim.	High Lim.	P/F
MinI_1	15.5	mA	15.5	15.5	15.5	0.0	299.9	P
MaxI_1	17.1	mA	17.1	17.1	17.1	10.0	299.9	P
Vport_1	48.1	VDC	48.1	48.1	48.1	37.0	57.0	INFO
Ppeak_1	0.82	W	0.82	0.82	0.82	0.0	14.4	P
Pavg_1	0.76	W	0.76	0.76	0.76	0.0	13.0	P
MPSViolation_1	0		0	0	—	0	0	P
TcutWindowViolation_1	0		0	0	—	0	0	P
DutyCycleViolation_1	0		0	0	—	0	0	P

10. Complete 5 V Si3404 Isolated Flyback Sifos Compatibility Test Reports

Table 10.1. Si3404-ISO-FB EVB, 5 V, Class 3 PD Sifos PoE Compatibility Test Results, PSE Emulation: Alt A MDI

Detection and Classification	PSE Emulation		Pairs	A	Polarity	MDI	Det_Cycles	3
Parameter Cycle	1	Units	Min.	Max.	Average	Low Lim.	High Lim.	P/F
Rdet	24.51	kΩ	24.51	24.51	24.51	23.70	26.30	P
Rdet_final	24.51	kΩ	24.51	24.51	24.51	23.70	26.30	P
Rdet_unpwr	>99.00	kΩ	99.00	99.00	99.00	<12.00	>45.00	P
Rdet_at_Vmin	24.66	kΩ	24.66	24.66	24.66	23.70	26.30	P
Rdet_at_Vmax	24.57	kΩ	24.57	24.57	24.57	23.70	26.30	P
Rdet_Voffset	1.0	VDC	1.0	1.0	1.0	0.0	1.9	P
Cdet	0.10	μF	0.10	0.10	0.10	0.05	0.12	P
Cdet_final	0.10	μF	0.10	0.10	0.10	0.05	0.12	P
1 Event Classification								
Iclass	28.3	mA	28.3	28.3	28.3	26.0	30.0	P
ClassNum	3		3	3	—	0	4	P
Tclass	0.0005	s	0.0005	0.0005	0.0005	0.0005	0.0050	P
ClassStability	1					1	1	P
Iclass_at_Vmin	28.5	mA	28.5	28.5	28.5	26.0	30.0	P
Iclass_at_Vmax	28.1	mA	28.1	28.1	28.1	26.0	30.0	P
2 Event Classification								
Iclass_event1	28.3	mA	28.3	28.3	28.3	26.0	30.0	P
Iclass_event2	28.3	mA	28.3	28.3	28.3	26.0	30.0	P
MarkI	1.72	mA	1.72	1.72	1.72	0.25	4.00	INFO
ClassNum2	3		3	3	—	0	4	P
Tclass_event1	0.0005	s	0.0005	0.0005	0.0005	0.0005	0.0050	P
Tclass_event2	0.0005	s	0.0005	0.0005	0.0005	0.0005	0.0050	P
ClassStability_event1	1					1	1	P
ClassStability_event2	1					1	1	P
Power-Up / Down								
Parameter Cycle	1	Units	Min.	Max.	Average	Low Lim.	High Lim.	P/F
InrushI_1	157.8	mA	157.8	157.8	157.8	0.0	400.0	P
InrushI_2	-1.0	mA	-1.0	-1.0	-1.0	0.0	400.0	NA
Pmax_Tdelay	-1.0	W	-1.0	-1.0	-1.0	0.0	0.0	NA
Inrush_delayed	0		0	0	—	0	0	P
Von	37.8	VDC	37.8	37.8	37.8	30.0	42.0	P
Voff	33.8	VDC	33.8	33.8	33.8	30.0	42.0	P

Vhyst	4.0	VDC	4.0	4.0	4.0	0.0	12.0	P
BackfeedV	0.1	VDC	0.1	0.1	0.1	0.0	2.8	P
ClassRecover	0		0	0	—	0	0	P
SigRecoverTime	0.0	s	0.0	0.0	0.0	0.0	30.0	P
MDI Powered Type-1	PSE Emulation		On Time	10 s	Off Time	10 s	Vport	48.0
Parameter Cycle	1	Units	Min.	Max.	Average	Low Lim.	High Lim.	P/F
MinI_1	17.9	mA	17.9	17.9	17.9	0.0	299.7	P
MaxI_1	19.5	mA	19.5	19.5	19.5	10.0	299.7	P
Vport_1	48.0	VDC	48.0	48.0	48.0	37.0	57.0	INFO
Ppeak_1	0.94	W	0.94	0.94	0.94	0.0	14.4	P
Pavg_1	0.88	W	0.88	0.88	0.88	0.0	13.0	P
MPSViolation_1	0		0	0	—	0	0	P
TcutWindowViolation_1	0		0	0	—	0	0	P
DutyCycleViolation_1	0		0	0	—	0	0	P

Table 10.2. Si3404-ISO-FB EVB, 5 V, Class 3 PD Sifos PoE Compatibility Test Results, PSE Emulation: Alt A MDI-X

Detection and Classification	PSE Emulation		Pairs	A	Polarity	MDI-X	Det_Cycles	3
Parameter Cycle	1	Units	Min.	Max.	Average	Low Lim.	High Lim.	P/F
Rdet	24.51	kΩ	24.51	24.51	24.51	23.70	26.30	P
Rdet_final	24.49	kΩ	24.49	24.49	24.49	23.70	26.30	P
Rdet_unpwr	>99.00	kΩ	99.00	99.00	99.00	<12.00	>45.00	P
Rdet_at_Vmin	24.70	kΩ	24.70	24.70	24.70	23.70	26.30	P
Rdet_at_Vmax	24.70	kΩ	24.70	24.70	24.70	23.70	26.30	P
Rdet_Voffset	1.0	VDC	1.0	1.0	1.0	0.0	1.9	P
Cdet	0.10	μF	0.10	0.10	0.10	0.05	0.12	P
Cdet_final	0.10	μF	0.10	0.10	0.10	0.05	0.12	P
1 Event Classification								
Iclass	28.3	mA	28.3	28.3	28.3	26.0	30.0	P
ClassNum	3		3	3	—	0	4	P
Tclass	0.0005	s	0.0005	0.0005	0.0005	0.0005	0.0050	P
ClassStability	1					1	1	P
Iclass_at_Vmin	28.6	mA	28.6	28.6	28.6	26.0	30.0	P
Iclass_at_Vmax	28.3	mA	28.3	28.3	28.3	26.0	30.0	P
2 Event Classification								
Iclass_event1	28.3	mA	28.3	28.3	28.3	26.0	30.0	P
Iclass_event2	28.3	mA	28.3	28.3	28.3	26.0	30.0	P
MarkI	1.72	mA	1.72	1.72	1.72	0.25	4.00	INFO
ClassNum2	3		3	3	—	0	4	P
Tclass_event1	0.0005	s	0.0005	0.0005	0.0005	0.0005	0.0050	P
Tclass_event2	0.0005	s	0.0005	0.0005	0.0005	0.0005	0.0050	P
ClassStability_event1	1					1	1	P
ClassStability_event2	1					1	1	P
Power-Up / Down								
Parameter Cycle	1	Units	Min.	Max.	Average	Low Lim.	High Lim.	P/F
InrushI_1	156.9	mA	156.9	156.9	156.9	0.0	400.0	P
InrushI_2	-1.0	mA	-1.0	-1.0	-1.0	0.0	400.0	NA
Pmax_Tdelay	-1.0	W	-1.0	-1.0	-1.0	0.0	0.0	NA
Inrush_delayed	0		0	0	—	0	0	P
Von	38.0	VDC	38.0	38.0	38.0	30.0	42.0	P
Voff	33.8	VDC	33.8	33.8	33.8	30.0	42.0	P
Vhyst	4.2	VDC	4.2	4.2	4.2	0.0	12.0	P
BackfeedV	0.0	VDC	0.0	0.0	0.0	0.0	2.8	P

ClassRecover	0		0	0	—	0	0	P
SigRecoverTime	0.0	s	0.0	0.0	0.0	0.0	30.0	P
MDI Powered Type-1	PSE Emulation		On Time	10 s	Off Time	10 s	Vport	48.0
Parameter Cycle	1	Units	Min.	Max.	Average	Low Lim.	High Lim.	P/F
MinI_1	17.8	mA	17.8	17.8	17.8	0.0	298.9	P
MaxI_1	19.3	mA	19.3	19.3	19.3	10.0	298.9	P
Vport_1	48.2	VDC	48.2	48.2	48.2	37.0	57.0	INFO
Ppeak_1	0.93	W	0.93	0.93	0.93	0.0	14.4	P
Pavg_1	0.88	W	0.88	0.88	0.88	0.0	13.0	P
MPSViolation_1	0		0	0	—	0	0	P
TcutWindowViolation_1	0		0	0	—	0	0	P
DutyCycleViolation_1	0		0	0	—	0	0	P

Table 10.3. Si3404-ISO-FB EVB, 5 V, Class 3 PD Sifos PoE Compatibility Test Results, PSE Emulation: Alt B MDI

Detection and Classification	PSE Emulation		Pairs	B	Polarity	MDI	Det_Cycles	3
Parameter Cycle	1	Units	Min.	Max.	Average	Low Lim.	High Lim.	P/F
Rdet	24.49	kΩ	24.49	24.49	24.49	23.70	26.30	P
Rdet_final	24.44	kΩ	24.44	24.44	24.44	23.70	26.30	P
Rdet_unpwr	>99.00	kΩ	99.00	99.00	99.00	<12.00	>45.00	P
Rdet_at_Vmin	24.76	kΩ	24.76	24.76	24.76	23.70	26.30	P
Rdet_at_Vmax	24.64	kΩ	24.64	24.64	24.64	23.70	26.30	P
Rdet_Voffset	1.0	VDC	1.0	1.0	1.0	0.0	1.9	P
Cdet	0.10	μF	0.10	0.10	0.10	0.05	0.12	P
Cdet_final	0.10	μF	0.10	0.10	0.10	0.05	0.12	P
1 Event Classification								
Iclass	28.5	mA	28.5	28.5	28.5	26.0	30.0	P
ClassNum	3		3	3	—	0	4	P
Tclass	0.0005	s	0.0005	0.0005	0.0005	0.0005	0.0050	P
ClassStability	1					1	1	P
Iclass_at_Vmin	28.4	mA	28.4	28.4	28.4	26.0	30.0	P
Iclass_at_Vmax	28.4	mA	28.4	28.4	28.4	26.0	30.0	P
2 Event Classification								
Iclass_event1	28.5	mA	28.5	28.5	28.5	26.0	30.0	P
Iclass_event2	28.5	mA	28.5	28.5	28.5	26.0	30.0	P
MarkI	1.79	mA	1.79	1.79	1.79	0.25	4.00	INFO
ClassNum2	3		3	3	—	0	4	P
Tclass_event1	0.0005	s	0.0005	0.0005	0.0005	0.0005	0.0050	P
Tclass_event2	0.0005	s	0.0005	0.0005	0.0005	0.0005	0.0050	P
ClassStability_event1	1					1	1	P
ClassStability_event2	1					1	1	P
Power-Up / Down								
Parameter Cycle	1	Units	Min.	Max.	Average	Low Lim.	High Lim.	P/F
InrushI_1	157.0	mA	157.0	157.0	157.0	0.0	400.0	P
InrushI_2	-1.0	mA	-1.0	-1.0	-1.0	0.0	400.0	NA
Pmax_Tdelay	-1.0	W	-1.0	-1.0	-1.0	0.0	0.0	NA
Inrush_delayed	0		0	0	—	0	0	P
Von	37.9	VDC	37.9	37.9	37.9	30.0	42.0	P
Voff	33.8	VDC	33.8	33.8	33.8	30.0	42.0	P
Vhyst	4.1	VDC	4.1	4.1	4.1	0.0	12.0	P
BackfeedV	0.1	VDC	0.1	0.1	0.1	0.0	2.8	P

ClassRecover	0		0	0	—	0	0	P
SigRecoverTime	0.0	s	0.0	0.0	0.0	0.0	30.0	P
MDI Powered Type-1	PSE Emulation		On Time	10 s	Off Time	10 s	Vport	48.0
Parameter Cycle	1	Units	Min.	Max.	Average	Low Lim.	High Lim.	P/F
MinI_1	17.4	mA	17.4	17.4	17.4	0.0	299.9	P
MaxI_1	18.9	mA	18.9	18.9	18.9	10.0	299.9	P
Vport_1	48.0	VDC	48.0	48.0	48.0	37.0	57.0	INFO
Ppeak_1	0.91	W	0.91	0.91	0.91	0.0	14.4	P
Pavg_1	0.86	W	0.86	0.86	0.86	0.0	13.0	P
MPSViolation_1	0		0	0	—	0	0	P
TcutWindowViolation_1	0		0	0	—	0	0	P
DutyCycleViolation_1	0		0	0	—	0	0	P

Table 10.4. Si3404-ISO-FB EVB, 5 V, Class 3 PD Sifos PoE Compatibility Test Results, PSE Emulation: Alt B MDI-X

Detection and Classification	PSE Emulation		Pairs	B	Polarity	MDI-X	Det_Cycles	3
Parameter Cycle	1	Units	Min.	Max.	Average	Low Lim.	High Lim.	P/F
Rdet	24.46	kΩ	24.46	24.46	24.46	23.70	26.30	P
Rdet_final	24.46	kΩ	24.46	24.46	24.46	23.70	26.30	P
Rdet_unpwr	>99.00	kΩ	99.00	99.00	99.00	<12.00	>45.00	P
Rdet_at_Vmin	24.77	kΩ	24.77	24.77	24.77	23.70	26.30	P
Rdet_at_Vmax	24.67	kΩ	24.67	24.67	24.67	23.70	26.30	P
Rdet_Voffset	1.0	VDC	1.0	1.0	1.0	0.0	1.9	P
Cdet	0.10	μF	0.10	0.10	0.10	0.05	0.12	P
Cdet_final	0.10	μF	0.10	0.10	0.10	0.05	0.12	P
1 Event Classification								
Iclass	28.5	mA	28.5	28.5	28.5	26.0	30.0	P
ClassNum	3		3	3	—	0	4	P
Tclass	0.0005	s	0.0005	0.0005	0.0005	0.0005	0.0050	P
ClassStability	1					1	1	P
Iclass_at_Vmin	28.7	mA	28.7	28.7	28.7	26.0	30.0	P
Iclass_at_Vmax	28.3	mA	28.3	28.3	28.3	26.0	30.0	P
2 Event Classification								
Iclass_event1	28.5	mA	28.5	28.5	28.5	26.0	30.0	P
Iclass_event2	28.5	mA	28.5	28.5	28.5	26.0	30.0	P
MarkI	1.80	mA	1.80	1.80	1.80	0.25	4.00	INFO
ClassNum2	3		3	3	—	0	4	P
Tclass_event1	0.0005	s	0.0005	0.0005	0.0005	0.0005	0.0050	P
Tclass_event2	0.0005	s	0.0005	0.0005	0.0005	0.0005	0.0050	P
ClassStability_event1	1					1	1	P
ClassStability_event2	1					1	1	P
Power-Up / Down								
Parameter Cycle	1	Units	Min.	Max.	Average	Low Lim.	High Lim.	P/F
InrushI_1	157.0	mA	157.0	157.0	157.0	0.0	400.0	P
InrushI_2	-1.0	mA	-1.0	-1.0	-1.0	0.0	400.0	NA
Pmax_Tdelay	-1.0	W	-1.0	-1.0	-1.0	0.0	0.0	NA
Inrush_delayed	0		0	0	—	0	0	P
Von	38.0	VDC	38.0	38.0	38.0	30.0	42.0	P
Voff	33.8	VDC	33.8	33.8	33.8	30.0	42.0	P
Vhyst	4.1	VDC	4.1	4.1	4.1	0.0	12.0	P
BackfeedV	0.0	VDC	0.0	0.0	0.0	0.0	2.8	P

ClassRecover	0		0	0	—	0	0	P
SigRecoverTime	0.0	s	0.0	0.0	0.0	0.0	30.0	P
MDI Powered Type-1	PSE Emulation		On Time	10 s	Off Time	10 s	Vport	48.0
Parameter Cycle	1	Units	Min.	Max.	Average	Low Lim.	High Lim.	P/F
MinI_1	17.4	mA	17.4	17.4	17.4	0.0	299.9	P
MaxI_1	19.4	mA	19.4	19.4	19.4	10.0	299.9	P
Vport_1	48.0	VDC	48.0	48.0	48.0	37.0	57.0	INFO
Ppeak_1	0.93	W	0.93	0.93	0.93	0.0	14.4	P
Pavg_1	0.85	W	0.85	0.85	0.85	0.0	13.0	P
MPSViolation_1	0		0	0	—	0	0	P
TcutWindowViolation_1	0		0	0	—	0	0	P
DutyCycleViolation_1	0		0	0	—	0	0	P

11. Complete 12 V Si3404 Isolated Flyback Sifos Compatibility Test Reports

Table 11.1. Si3404-ISO-FB EVB, 12 V, Class 3 PD Sifos PoE Compatibility Test Results, PSE Emulation: Alt A MDI

Detection and Classification	PSE Emulation		Pairs	A	Polarity	MDI	Det_Cycles	3
Parameter Cycle	1	Units	Min.	Max.	Average	Low Lim.	High Lim.	P/F
Rdet	24.49	kΩ	24.49	24.49	24.49	23.70	26.30	P
Rdet_final	24.40	kΩ	24.40	24.40	24.40	23.70	26.30	P
Rdet_unpwr	>99.00	kΩ	99.00	99.00	99.00	<12.00	>45.00	P
Rdet_at_Vmin	24.63	kΩ	24.63	24.63	24.63	23.70	26.30	P
Rdet_at_Vmax	24.54	kΩ	24.54	24.54	24.54	23.70	26.30	P
Rdet_Voffset	1.0	VDC	1.0	1.0	1.0	0.0	1.9	P
Cdet	0.10	μF	0.10	0.10	0.10	0.05	0.12	P
Cdet_final	0.10	μF	0.10	0.10	0.10	0.05	0.12	P
1 Event Classification								
Iclass	28.5	mA	28.5	28.5	28.5	26.0	30.0	P
ClassNum	3		3	3	—	0	4	P
Tclass	0.0005	s	0.0005	0.0005	0.0005	0.0005	0.0050	P
ClassStability	1					1	1	P
Iclass_at_Vmin	29.0	mA	29.0	29.0	29.0	26.0	30.0	P
Iclass_at_Vmax	28.4	mA	28.4	28.4	28.4	26.0	30.0	P
2 Event Classification								
Iclass_event1	28.5	mA	28.5	28.5	28.5	26.0	30.0	P
Iclass_event2	28.5	mA	28.5	28.5	28.5	26.0	30.0	P
MarkI	1.74	mA	1.74	1.74	1.74	0.25	4.00	INFO
ClassNum2	3		3	3	—	0	4	P
Tclass_event1	0.0005	s	0.0005	0.0005	0.0005	0.0005	0.0050	P
Tclass_event2	0.0005	s	0.0005	0.0005	0.0005	0.0005	0.0050	P
ClassStability_event1	1					1	1	P
ClassStability_event2	1					1	1	P
Power-Up / Down								
Parameter Cycle	1	Units	Min.	Max.	Average	Low Lim.	High Lim.	P/F
InrushI_1	157.0	mA	157.0	157.0	157.0	0.0	400.0	P
InrushI_2	-1.0	mA	-1.0	-1.0	-1.0	0.0	400.0	NA
Pmax_Tdelay	-1.0	W	-1.0	-1.0	-1.0	0.0	0.0	NA
Inrush_delayedVon	0		0	0	—	0	0	P
	38.1	VDC	38.1	38.1	38.1	30.0	42.0	P
Voff	34.2	VDC	34.2	34.2	34.2	30.0	42.0	P

Vhyst	3.9	VDC	3.9	3.9	3.9	0.0	12.0	P
BackfeedV	0.1	VDC	0.1	0.1	0.1	0.0	2.8	P
ClassRecover	0		0	0	—	0	0	P
SigRecoverTime	0.0	s	0.0	0.0	0.0	0.0	30.0	P
MDI Powered Type-1	PSE Emulation		On Time	10 s	Off Time	10 s	Vport	48.0
Parameter Cycle	1	Units	Min.	Max.	Average	Low Lim.	High Lim.	P/F
MinI_1	38.4	mA	38.4	38.4	38.4	0.0	300.0	P
MaxI_1	40.9	mA	40.9	40.9	40.9	10.0	300.0	P
Vport_1	47.9	VDC	47.9	47.9	47.9	37.0	57.0	INFO
Ppeak_1	1.96	W	1.96	1.96	1.96	0.0	14.4	P
Pavg_1	1.86	W	1.86	1.86	1.86	0.0	13.0	P
MPSViolation_1	0		0	0	—	0	0	P
TcutWindowViolation_1	0		0	0	—	0	0	P
DutyCycleViolation_1	0		0	0	—	0	0	P

Table 11.2. Si3404-ISO-FB EVB, 12 V, Class 3 PD Sifos PoE Compatibility Test Results, PSE Emulation: Alt A MDI-X

Detection and Classification	PSE Emulation		Pairs	A	Polarity	MDI-X	Det_Cycles	3
Parameter Cycle	1	Units	Min.	Max.	Average	Low Lim.	High Lim.	P/F
Rdet	24.37	kΩ	24.37	24.37	24.37	23.70	26.30	P
Rdet_final	24.33	kΩ	24.33	24.33	24.33	23.70	26.30	P
Rdet_unpwr	>99.00	kΩ	99.00	99.00	99.00	<12.00	>45.00	P
Rdet_at_Vmin	24.62	kΩ	24.62	24.62	24.62	23.70	26.30	P
Rdet_at_Vmax	24.55	kΩ	24.55	24.55	24.55	23.70	26.30	P
Rdet_Voffset	1.0	VDC	1.0	1.0	1.0	0.0	1.9	P
Cdet	0.10	μF	0.10	0.10	0.10	0.05	0.12	P
Cdet_final	0.10	μF	0.10	0.10	0.10	0.05	0.12	P
1 Event Classification								
Iclass	28.4	mA	28.4	28.4	28.4	26.0	30.0	P
ClassNum	3		3	3	—	0	4	P
Tclass	0.0005	s	0.0005	0.0005	0.0005	0.0005	0.0050	P
ClassStability	1					1	1	P
Iclass_at_Vmin	28.6	mA	28.6	28.6	28.6	26.0	30.0	P
Iclass_at_Vmax	28.4	mA	28.4	28.4	28.4	26.0	30.0	P
2 Event Classification								
Iclass_event1	28.5	mA	28.5	28.5	28.5	26.0	30.0	P
Iclass_event2	28.5	mA	28.5	28.5	28.5	26.0	30.0	P
MarkI	1.74	mA	1.74	1.74	1.74	0.25	4.00	INFO
ClassNum2	3		3	3	—	0	4	P
Tclass_event1	0.0005	s	0.0005	0.0005	0.0005	0.0005	0.0050	P
Tclass_event2	0.0005	s	0.0005	0.0005	0.0005	0.0005	0.0050	P
ClassStability_event1	1					1	1	P
ClassStability_event2	1					1	1	P
Power-Up / Down								
Parameter Cycle	1	Units	Min.	Max.	Average	Low Lim.	High Lim.	P/F
InrushI_1	156.2	mA	156.2	156.2	156.2	0.0	400.0	P
InrushI_2	-1.0	mA	-1.0	-1.0	-1.0	0.0	400.0	NA
Pmax_Tdelay	-1.0	W	-1.0	-1.0	-1.0	0.0	0.0	NA
Inrush_delayed	0		0	0	—	0	0	P
Von	38.3	VDC	38.3	38.3	38.3	30.0	42.0	P
Voff	34.4	VDC	34.4	34.4	34.4	30.0	42.0	P
Vhyst	3.9	VDC	3.9	3.9	3.9	0.0	12.0	P
BackfeedV	0.0	VDC	0.0	0.0	0.0	0.0	2.8	P

ClassRecover	0		0	0	—	0	0	P
SigRecoverTime	0.0	s	0.0	0.0	0.0	0.0	30.0	P
MDI Powered Type-1	PSE Emulation		On Time	10 s	Off Time	10 s	Vport	48.0
Parameter Cycle	1	Units	Min.	Max.	Average	Low Lim.	High Lim.	P/F
MinI_1	38.3	mA	38.3	38.3	38.3	0.0	299.4	P
MaxI_1	40.5	mA	40.5	40.5	40.5	10.0	299.4	P
Vport_1	48.0	VDC	48.0	48.0	48.0	37.0	57.0	INFO
Ppeak_1	1.94	W	1.94	1.94	1.94	0.0	14.4	P
Pavg_1	1.86	W	1.86	1.86	1.86	0.0	13.0	P
MPSViolation_1	0		0	0	—	0	0	P
TcutWindowViolation_1	0		0	0	—	0	0	P
DutyCycleViolation_1	0		0	0	—	0	0	P

Table 11.3. Si3404-ISO-FB EVB, 12 V, Class 3 PD Sifos PoE Compatibility Test Results, PSE Emulation: Alt B MDI

Detection and Classification	PSE Emulation		Pairs	B	Polarity	MDI	Det_Cycles	3
Parameter Cycle	1	Units	Min.	Max.	Average	Low Lim.	High Lim.	P/F
Rdet	24.42	kΩ	24.42	24.42	24.42	23.70	26.30	P
Rdet_final	24.42	kΩ	24.42	24.42	24.42	23.70	26.30	P
Rdet_unpwr	>99.00	kΩ	99.00	99.00	99.00	<12.00	>45.00	P
Rdet_at_Vmin	24.56	kΩ	24.56	24.56	24.56	23.70	26.30	P
Rdet_at_Vmax	24.64	kΩ	24.64	24.64	24.64	23.70	26.30	P
Rdet_Voffset	1.0	VDC	1.0	1.0	1.0	0.0	1.9	P
Cdet	0.10	μF	0.10	0.10	0.10	0.05	0.12	P
Cdet_final	0.10	μF	0.10	0.10	0.10	0.05	0.12	P
1 Event Classification								
Iclass	28.6	mA	28.6	28.6	28.6	26.0	30.0	P
ClassNum	3		3	3	—	0	4	P
Tclass	0.0005	s	0.0005	0.0005	0.0005	0.0005	0.0050	P
ClassStability	1					1	1	P
Iclass_at_Vmin	28.8	mA	28.8	28.8	28.8	26.0	30.0	P
Iclass_at_Vmax	28.4	mA	28.4	28.4	28.4	26.0	30.0	P
2 Event Classification								
Iclass_event1	28.6	mA	28.6	28.6	28.6	26.0	30.0	P
Iclass_event2	28.6	mA	28.6	28.6	28.6	26.0	30.0	P
MarkI	1.81	mA	1.81	1.81	1.81	0.25	4.00	INFO
ClassNum2	3		3	3	—	0	4	P
Tclass_event1	0.0005	s	0.0005	0.0005	0.0005	0.0005	0.0050	P
Tclass_event2	0.0005	s	0.0005	0.0005	0.0005	0.0005	0.0050	P
ClassStability_event1	1					1	1	P
ClassStability_event2	1					1	1	P
Power-Up / Down								
Parameter Cycle	1	Units	Min.	Max.	Average	Low Lim.	High Lim.	P/F
InrushI_1	156.5	mA	156.5	156.5	156.5	0.0	400.0	P
InrushI_2	-1.0	mA	-1.0	-1.0	-1.0	0.0	400.0	NA
Pmax_Tdelay	-1.0	W	-1.0	-1.0	-1.0	0.0	0.0	NA
Inrush_delayed	0		0	0	—	0	0	P
Von	38.2	VDC	38.2	38.2	38.2	30.0	42.0	P
Voff	34.3	VDC	34.3	34.3	34.3	30.0	42.0	P
Vhyst	3.9	VDC	3.9	3.9	3.9	0.0	12.0	P
BackfeedV	0.0	VDC	0.0	0.0	0.0	0.0	2.8	P

ClassRecover	0		0	0	—	0	0	P
SigRecoverTime	0.0	s	0.0	0.0	0.0	0.0	30.0	P
MDI Powered Type-1	PSE Emulation		On Time	10 s	Off Time	10 s	Vport	48.0
Parameter Cycle	1	Units	Min.	Max.	Average	Low Lim.	High Lim.	P/F
MinI_1	37.7	mA	37.7	37.7	37.7	0.0	300.0	P
MaxI_1	40.5	mA	40.5	40.5	40.5	10.0	300.0	P
Vport_1	47.8	VDC	47.8	47.8	47.8	37.0	57.0	INFO
Ppeak_1	1.94	W	1.94	1.94	1.94	0.0	14.4	P
Pavg_1	1.84	W	1.84	1.84	1.84	0.0	13.0	P
MPSViolation_1	0		0	0	—	0	0	P
TcutWindowViolation_1	0		0	0	—	0	0	P
DutyCycleViolation_1	0		0	0	—	0	0	P

Table 11.4. Si3404-ISO-FB EVB, 12 V, Class 3 PD Sifos PoE Compatibility Test Results, PSE Emulation: Alt B MDI-X

Detection and Classification	PSE Emulation		Pairs	B	Polarity	MDI-X	Det_Cycles	3
Parameter Cycle	1	Units	Min.	Max.	Average	Low Lim.	High Lim.	P/F
Rdet	24.37	kΩ	24.37	24.37	24.37	23.70	26.30	P
Rdet_final	24.37	kΩ	24.37	24.37	24.37	23.70	26.30	P
Rdet_unpwr	>99.00	kΩ	99.00	99.00	99.00	<12.00	>45.00	P
Rdet_at_Vmin	24.58	kΩ	24.58	24.58	24.58	23.70	26.30	P
Rdet_at_Vmax	24.57	kΩ	24.57	24.57	24.57	23.70	26.30	P
Rdet_Voffset	1.0	VDC	1.0	1.0	1.0	0.0	1.9	P
Cdet	0.10	μF	0.10	0.10	0.10	0.05	0.12	P
Cdet_final	0.10	μF	0.10	0.10	0.10	0.05	0.12	P
1 Event Classification								
Iclass	28.6	mA	28.6	28.6	28.6	26.0	30.0	P
ClassNum	3		3	3	—	0	4	P
Tclass	0.0005	s	0.0005	0.0005	0.0005	0.0005	0.0050	P
ClassStability	1					1	1	P
Iclass_at_Vmin	28.4	mA	28.4	28.4	28.4	26.0	30.0	P
Iclass_at_Vmax	28.5	mA	28.5	28.5	28.5	26.0	30.0	P
2 Event Classification								
Iclass_event1	28.6	mA	28.6	28.6	28.6	26.0	30.0	P
Iclass_event2	28.6	mA	28.6	28.6	28.6	26.0	30.0	P
MarkI	1.81	mA	1.81	1.81	1.81	0.25	4.00	INFO
ClassNum2	3		3	3	—	0	4	P
Tclass_event1	0.0005	s	0.0005	0.0005	0.0005	0.0005	0.0050	P
Tclass_event2	0.0005	s	0.0005	0.0005	0.0005	0.0005	0.0050	P
ClassStability_event1	1					1	1	P
ClassStability_event2	1					1	1	P
Power-Up / Down								
Parameter Cycle	1	Units	Min.	Max.	Average	Low Lim.	High Lim.	P/F
InrushI_1	156.2	mA	156.2	156.2	156.2	0.0	400.0	P
InrushI_2	-1.0	mA	-1.0	-1.0	-1.0	0.0	400.0	NA
Pmax_Tdelay	-1.0	W	-1.0	-1.0	-1.0	0.0	0.0	NA
Inrush_delayed	0		0	0	—	0	0	P
Von	38.2	VDC	38.2	38.2	38.2	30.0	42.0	P
Voff	34.3	VDC	34.3	34.3	34.3	30.0	42.0	P
Vhyst	3.9	VDC	3.9	3.9	3.9	0.0	12.0	P
BackfeedV	0.0	VDC	0.0	0.0	0.0	0.0	2.8	P

ClassRecover	0		0	0	—	0	0	P
SigRecoverTime	0.0	s	0.0	0.0	0.0	0.0	30.0	P
MDI Powered Type-1	PSE Emulation		On Time	10 s	Off Time	10 s	Vport	48.0
Parameter Cycle	1	Units	Min.	Max.	Average	Low Lim.	High Lim.	P/F
MinI_1	37.7	mA	37.7	37.7	37.7	0.0	300.0	P
MaxI_1	40.5	mA	40.5	40.5	40.5	10.0	300.0	P
Vport_1	47.9	VDC	47.9	47.9	47.9	37.0	57.0	INFO
Ppeak_1	1.94	W	1.94	1.94	1.94	0.0	14.4	P
Pavg_1	1.85	W	1.85	1.85	1.85	0.0	13.0	P
MPSViolation_1	0		0	0	—	0	0	P
TcutWindowViolation_1	0		0	0	—	0	0	P
DutyCycleViolation_1	0		0	0	—	0	0	P



SKYWORKS®

**Connecting Everyone
and Everything,
All the Time**



Portfolio

www.skyworksinc.com

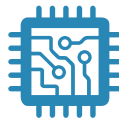

Quality

www.skyworksinc.com/quality



Support & Resources

www.skyworksinc.com/support

Copyright © 2021 Skyworks Solutions, Inc. All Rights Reserved.

Information in this document is provided in connection with Skyworks Solutions, Inc. ("Skyworks") products or services. These materials, including the information contained herein, are provided by Skyworks as a service to its customers and may be used for informational purposes only by the customer. Skyworks assumes no responsibility for errors or omissions in these materials or the information contained herein. Skyworks may change its documentation, products, services, specifications or product descriptions at any time, without notice. Skyworks makes no commitment to update the materials or information and shall have no responsibility whatsoever for conflicts, incompatibilities, or other difficulties arising from any future changes.

No license, whether express, implied, by estoppel or otherwise, is granted to any intellectual property rights by this document. Skyworks assumes no liability for any materials, products or information provided hereunder, including the sale, distribution, reproduction or use of Skyworks products, information or materials, except as may be provided in Skyworks' Terms and Conditions of Sale.

THE MATERIALS, PRODUCTS AND INFORMATION ARE PROVIDED "AS IS" WITHOUT WARRANTY OF ANY KIND, WHETHER EXPRESS, IMPLIED, STATUTORY, OR OTHERWISE, INCLUDING FITNESS FOR A PARTICULAR PURPOSE OR USE, MERCHANTABILITY, PERFORMANCE, QUALITY OR NON-INFRINGEMENT OF ANY INTELLECTUAL PROPERTY RIGHT; ALL SUCH WARRANTIES ARE HEREBY EXPRESSLY DISCLAIMED. SKYWOKS DOES NOT WARRANT THE ACCURACY OR COMPLETENESS OF THE INFORMATION, TEXT, GRAPHICS OR OTHER ITEMS CONTAINED WITHIN THESE MATERIALS. SKYWOKS SHALL NOT BE LIABLE FOR ANY DAMAGES, INCLUDING BUT NOT LIMITED TO ANY SPECIAL, INDIRECT, INCIDENTAL, STATUTORY, OR CONSEQUENTIAL DAMAGES, INCLUDING WITHOUT LIMITATION, LOST REVENUES OR LOST PROFITS THAT MAY RESULT FROM THE USE OF THE MATERIALS OR INFORMATION, WHETHER OR NOT THE RECIPIENT OF MATERIALS HAS BEEN ADVISED OF THE POSSIBILITY OF SUCH DAMAGE.

Skyworks products are not intended for use in medical, lifesaving or life-sustaining applications, or other equipment in which the failure of the Skyworks products could lead to personal injury, death, physical or environmental damage. Skyworks customers using or selling Skyworks products for use in such applications do so at their own risk and agree to fully indemnify Skyworks for any damages resulting from such improper use or sale.

Customers are responsible for their products and applications using Skyworks products, which may deviate from published specifications as a result of design defects, errors, or operation of products outside of published parameters or design specifications. Customers should include design and operating safeguards to minimize these and other risks. Skyworks assumes no liability for applications assistance, customer product design, or damage to any equipment resulting from the use of Skyworks products outside of Skyworks' published specifications or parameters.

Skyworks, the Skyworks symbol, Sky5®, SkyOne®, SkyBlue™, Skyworks Green™, Clockbuilder®, DSPLL®, ISOModem®, ProSLIC®, and SiPHY® are trademarks or registered trademarks of Skyworks Solutions, Inc. or its subsidiaries in the United States and other countries. Third-party brands and names are for identification purposes only and are the property of their respective owners. Additional information, including relevant terms and conditions, posted at www.skyworksinc.com, are incorporated by reference.

Skyworks Solutions, Inc. | Nasdaq: SWKS | sales@skyworksinc.com | www.skyworksinc.com

USA: 781-376-3000 | Asia: 886-2-2735 0399 | Europe: 33 (0)1 43548540 | [in](https://www.linkedin.com/company/skyworks) [f](https://www.facebook.com/skyworks) [t](https://twitter.com/skyworks) [y](https://www.youtube.com/skyworks)