

MACX MCR-SL-RPSS-2I-2I - Repeater power supply



2904089

<https://www.phoenixcontact.com/us/products/2904089>

Please be informed that the data shown in this PDF document is generated from our online catalog. Please find the complete data in the user documentation. Our general terms of use for downloads are valid.



2-channel repeater power supply for operating 2-conductor measuring transducers, input: 4 ... 20 mA (supplying), output: 4 ... 20 mA (active), bidirectional transmission with digital HART transparency, screw connection, SIL, PL.

Commercial data

Item number	2904089
Packing unit	1 pc
Minimum order quantity	1 pc
Sales key	C402
Product key	CK1111
Catalog page	Page 123 (C-5-2019)
GTIN	4046356772792
Weight per piece (including packing)	250.1 g
Weight per piece (excluding packing)	140 g
Customs tariff number	85437090
Country of origin	DE

MACX MCR-SL-RPSS-2I-2I - Repeater power supply



2904089

<https://www.phoenixcontact.com/us/products/2904089>

Technical data

Product properties

Product type	Repeater power supplies
Product family	MACX Analog
Application	Analog IN
No. of channels	2
Type	Signal conditioners with SIL and PL Functional Safety

Data management status

Article revision	05
------------------	----

Electrical properties

Signal transmission behavior	In = Out
Step response (10-90%)	< 1.3 ms (for 4 mA ... 20 mA step)
Maximum temperature coefficient	< 0.01 %/K
Maximum transmission error	< 0.1 % (of final value 20 mA)
Transmission error, typical	< 0.05 % (of final value 20 mA)

Electrical isolation

Overvoltage category	II
Pollution degree	2

Electrical isolation Input/output, power supply IEC/EN 61010-1

Standards/regulations	IEC/EN 61010-1
Rated insulation voltage	300 V _{rms}
Test voltage	2.5 kV AC (50 Hz, 60 s)
Insulation	Safe isolation

Electrical isolation Output 1/output 2/ power supply

Test voltage	1.5 kV AC (50 Hz, 60 s)
--------------	-------------------------

Supply

Nominal supply voltage	24 V DC -20 % ... +25 %
Supply voltage range	19.2 V DC ... 30 V DC
Max. current consumption	< 100 mA (24 V DC / 20 mA)
Power dissipation	< 1.4 W (24 V DC / 20 mA)
Power consumption	≤ 2.4 W

Input data

Signal: Current

Number of inputs	2
Current input signal	4 mA ... 20 mA
Transmitter supply voltage	> 16 V (20 mA)
Underload/overload signal range	0 mA ... 24 mA

MACX MCR-SL-RPSS-2I-2I - Repeater power supply



2904089

<https://www.phoenixcontact.com/us/products/2904089>

Output data

Signal

Output description	Current output
Number of outputs	2
Current output signal	4 mA ... 20 mA (active)
Load/output load current output	$\leq 450 \Omega$ (20 mA) $\leq 375 \Omega$ (24 mA)
Output behavior in the event of an error	< 3.6 mA (In the event of cable break at the input (as per NE 43)) > 22.5 mA (In the event of cable short circuit at the input (as per NE 43))
Underload/overload signal range	0 mA ... 24 mA

Connection data

Connection method	Screw connection
Stripping length	7 mm
Screw thread	M3
Conductor cross section rigid	0.2 mm ² ... 2.5 mm ²
Conductor cross section flexible	0.2 mm ² ... 2.5 mm ²
Conductor cross section AWG	24 ... 14
Tightening torque	0.5 Nm ... 0.6 Nm

Test socket

Max. diameter	2 mm
---------------	------

Ex data

Ex installation (EPL)	Gc Div. 2
-----------------------	--------------

Interfaces

Data communication (bypass)

HART function	Yes
Protocols supported	HART-transparent

Signaling

Status display	Green LED (supply voltage)
----------------	----------------------------

Dimensions

Dimensional drawing	
---------------------	--

MACX MCR-SL-RPSS-2I-2I - Repeater power supply



2904089

<https://www.phoenixcontact.com/us/products/2904089>

Width	12.5 mm
Height	112.5 mm
Depth	113.7 mm
Depth NS 35/7,5	114.5 mm (Snapped onto DIN rail NS 35/7,5 in accordance with EN 60715)

Material specifications

Color	gray (RAL 7042)
Flammability rating according to UL 94	V0 (Housing)
Housing material	PA 6.6-FR

Environmental and real-life conditions

Ambient conditions

Degree of protection	IP20 (not assessed by UL)
Ambient temperature (operation)	-40 °C ... 60 °C (Any mounting position) -40 °C ... 70 °C (Derating)
Ambient temperature (storage/transport)	-40 °C ... 80 °C
Permissible humidity (operation)	10 % ... 95 % (non-condensing)

Altitude range (≤ 2000 m)

Altitude	≤ 2000 m (The technical data refers to altitudes ≤2000 m above mean sea level. For altitudes >2000 m above mean sea level, refer to the data sheet.)
Ambient temperature (operation)	-40 °C ... 60 °C -40 °C ... 70 °C (Derating)
Rated insulation voltage	375 V _{PP} (Power supply, input / output)

Altitude range (≤ 3000 m)

Height range	> 2000 m ... 3000 m
Ambient temperature (operation)	-40 °C ... 54 °C -40 °C ... 63 °C (Derating)
Rated insulation voltage	190 V AC (Power supply, input / output) 110 V DC (Power supply, input / output)

Altitude range (≤ 4000 m)

Height range	> 3000 m ... 4000 m
Ambient temperature (operation)	-40 °C ... 48 °C -40 °C ... 56 °C (Derating)
Rated insulation voltage	60 V AC/DC (Power supply, input / output)

Altitude range (≤ 5000 m)

Height range	> 4000 m ... 5000 m
Ambient temperature (operation)	-40 °C ... 42 °C -40 °C ... 49 °C (Derating)
Rated insulation voltage	60 V AC/DC (Power supply, input / output)

Approvals

MACX MCR-SL-RPSS-2I-2I - Repeater power supply



2904089

<https://www.phoenixcontact.com/us/products/2904089>

CE

Certificate	CE-compliant
Note	and EN 61326

ATEX

Identification	⊕ II 3 G Ex ec IIC T4 Gc X
Certificate	PxCIF11ATEX2924825X

UKCA Ex (UKEX)

Identification	⊕ II 3 G Ex nA IIC T4 Gc
Certificate	PxCIF21UKEX2904089X

IECEX

Identification	Ex ec IIC T4 Gc
Certificate	IECEX BVS 10.0097X

CCC / China-Ex

Identification	Ex ec IIC T4 Gc
Certificate	2022122316115972

UL, USA/Canada

Identification	UL 508 Listed
	UL 61010 Listed
	Class I, Div. 2, Groups A, B, C, D T4
	Class I, Zone 2, Groups IIC, IIB, IIA T4

UL, USA/Canada

Identification	UL 61010 Listed
	Class I, Div. 2, Groups A, B, C, D T4
	Class I, Zone 2, Group IIC T4

Shipbuilding approval

Certificate	DNV GL TAA000020C
-------------	-------------------

Safety Integrity Level (SIL, IEC 61508)

Identification	3
Certificate	BVS PB 04-13

Performance Level (ISO 13849)

Identification	d
----------------	---

DNV GL data

Temperature	B
Humidity	B
Vibration	A
EMC	A
Enclosure	Required protection according to the Rules shall be provided upon installation on board

MACX MCR-SL-RPSS-2I-2I - Repeater power supply



2904089

<https://www.phoenixcontact.com/us/products/2904089>

EMC data

Noise immunity	EN 61000-6-2
Note	When being exposed to interference, there may be minimal deviations.
Electromagnetic compatibility	Conformance with EMC directive
Noise emission	EN 61000-6-4

Mounting

Mounting type	DIN rail mounting
---------------	-------------------

Drawings

Block diagram

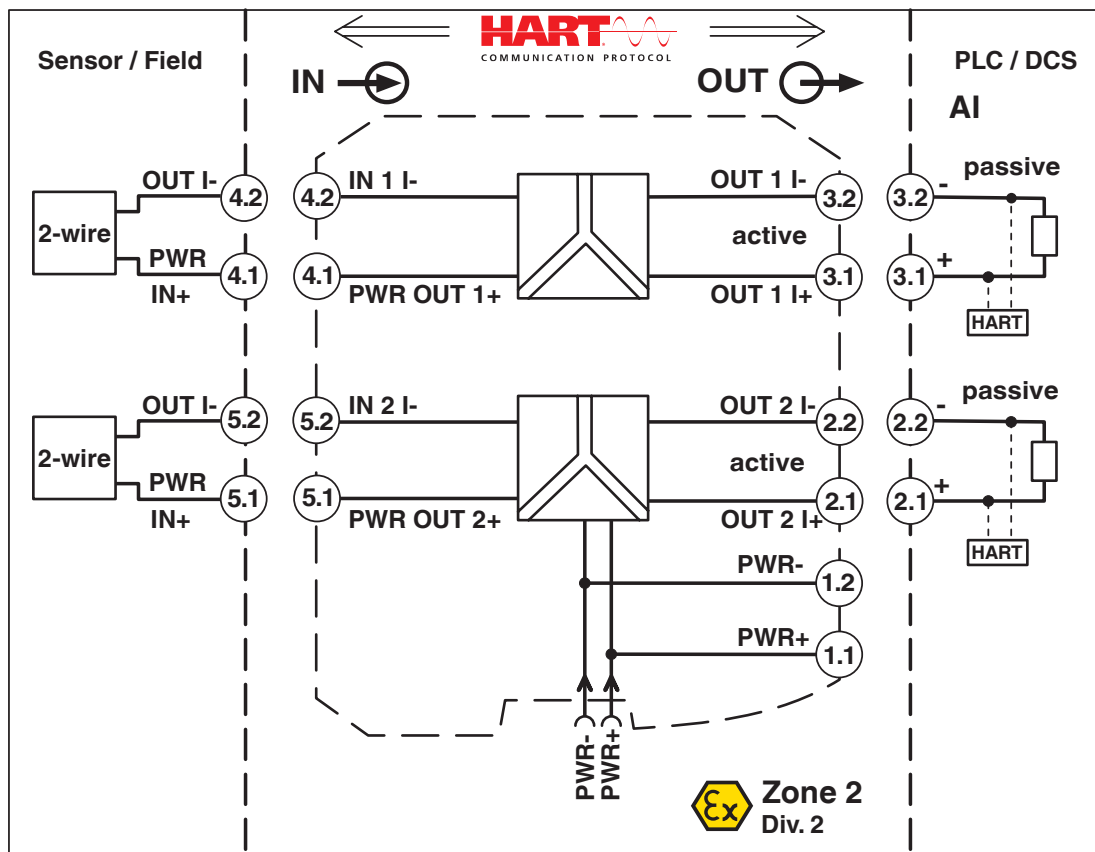

Diagram

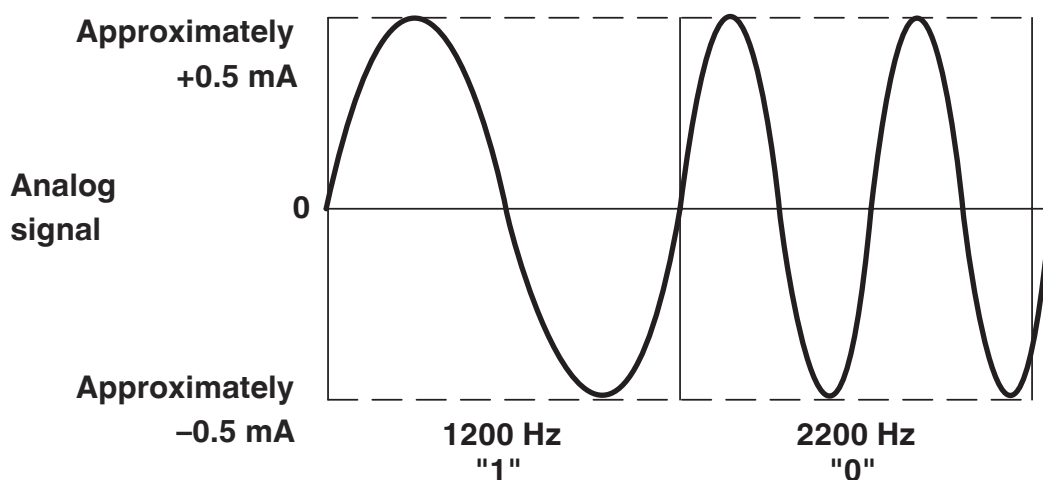

Signal transmission analog and digital at the same time

MACX MCR-SL-RPSS-2I-2I - Repeater power supply

2904089

<https://www.phoenixcontact.com/us/products/2904089>



Dimensional drawing

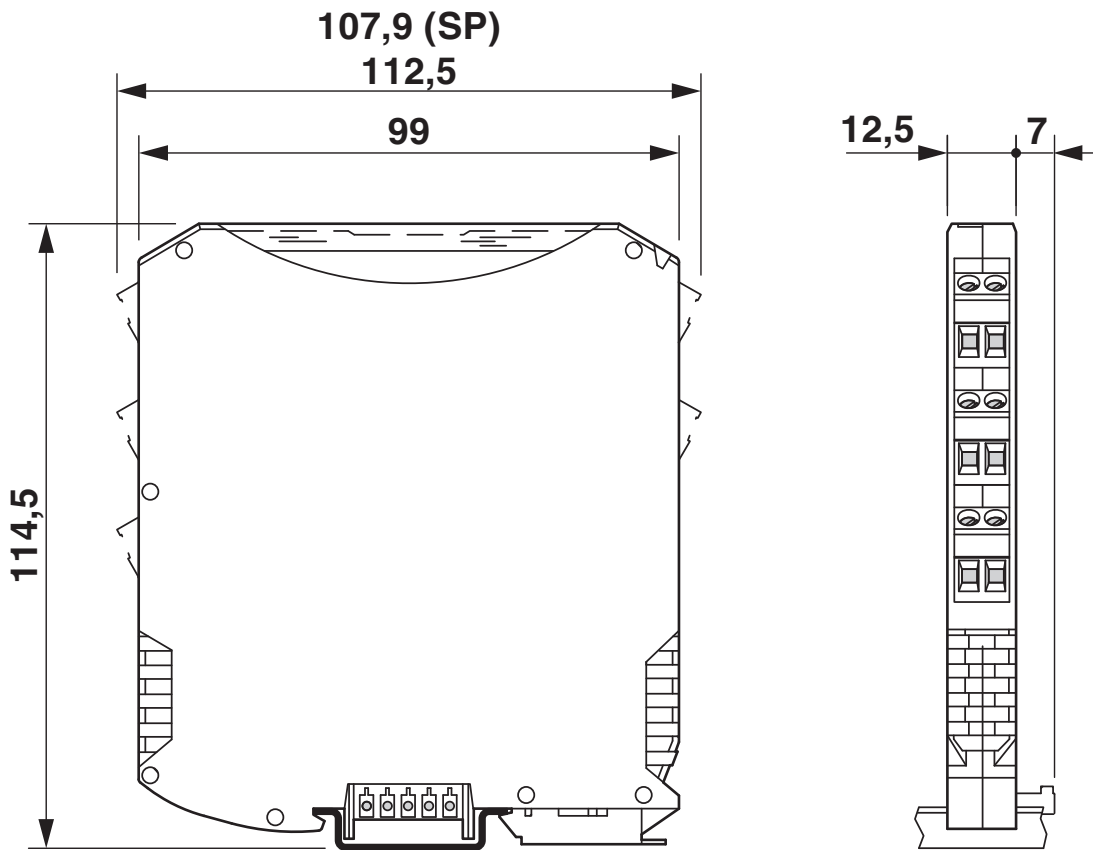

MACX MCR-SL-RPSS-2I-2I - Repeater power supply



2904089

<https://www.phoenixcontact.com/us/products/2904089>

Approvals

To download certificates, visit the product detail page: <https://www.phoenixcontact.com/us/products/2904089>



DNV GL

Approval ID: TAA000020C



UL Listed

Approval ID: E330267

Functional Safety

Approval ID: BVS Pb 04/13



cUL Listed

Approval ID: E199827



UL Listed

Approval ID: FILE E 199827



EAC Ex

Approval ID: TP012 103.01 00078



IECEx

Approval ID: IECEx BVS 10.0097X



CCC

Approval ID: 2022122316115972

cULus Listed

MACX MCR-SL-RPSS-2I-2I - Repeater power supply



2904089

<https://www.phoenixcontact.com/us/products/2904089>

Classifications

ECLASS

ECLASS-11.0	27210120
ECLASS-12.0	27210120
ECLASS-13.0	27210120

ETIM

ETIM 9.0	EC002653
----------	----------

UNSPSC

UNSPSC 21.0	39121000
-------------	----------

2904089

<https://www.phoenixcontact.com/us/products/2904089>

Environmental product compliance

EU RoHS

Fulfills EU RoHS substance requirements	Yes
Exemption	6(c), 7(a), 7(c)-I

China RoHS

Environment friendly use period (EFUP)	EFUP-50
	An article-related China RoHS declaration table can be found in the download area for the respective article under "Manufacturer declaration". For all articles with EFUP-E, no China RoHS declaration table issued and required.

EU REACH SVHC

REACH candidate substance (CAS No.)	Lead(CAS: 7439-92-1)
	2,2',6,6'-tetrabromo-4,4'-isopropylidenediphenol(CAS: 79-94-7)
SCIP	a15fa0fe-8c0a-4cf1-bfb6-8ba05b9f8d44

MACX MCR-SL-RPSS-2I-2I - Repeater power supply



2904089

<https://www.phoenixcontact.com/us/products/2904089>

Accessories

ME 6,2 TBUS-2 1,5/5-ST-3,81 GY - DIN rail bus connectors

2695439

<https://www.phoenixcontact.com/us/products/2695439>

DIN rail connector (TBUS), 5-pos., for bridging the supply voltage, can be snapped onto NS 35/... DIN rail in accordance with EN 60715



ME 6,2 TBUS-PR-ADAPTER - DIN rail bus connectors

1136500

<https://www.phoenixcontact.com/us/products/1136500>

Power rail adapter (ME 6,2 TBUS-PR-ADAPTER), 2-pos., enables MINI and MACX Analog modules to be adapted for supply via universal power rail UPR-03 and UPR-05.



MACX MCR-SL-RPSS-2I-2I - Repeater power supply

2904089

<https://www.phoenixcontact.com/us/products/2904089>



MCR-DP - Separating plate

1430594

<https://www.phoenixcontact.com/us/products/1430594>



The partition plate is used to maintain Ex i isolating distances when Ex i and non-Ex i devices are mounted side by side on a DIN rail.

GW HART USB MODEM - Cable adapter

1003824

<https://www.phoenixcontact.com/us/products/1003824>



USB HART modem cable for communication between a PC and HART devices, cable length: 1 m.

MACX MCR-SL-RPSS-2I-2I - Repeater power supply



2904089

<https://www.phoenixcontact.com/us/products/2904089>

TC-2D37SUB-ADIO32-2EX-P-UNI - Module carrier

2904684

<https://www.phoenixcontact.com/us/products/2904684>



Universal Termination Carrier for connecting 16 two-channel MACX Analog Ex i signal conditioners to digital or analog I/O cards, via two D-SUB connectors, 37-pos. (1:1 connection)

EA-MSTB 2,5/ 5 - Accessories

1831016

<https://www.phoenixcontact.com/us/products/1831016>



Cover for screw shafts of the MSTB connector ranges with a pitch of 5.0 mm and 5.08 mm. These can be aligned and shortened for use with different numbers of positions.

MACX MCR-SL-RPSS-2I-2I - Repeater power supply

2904089

<https://www.phoenixcontact.com/us/products/2904089>



MPS-IH WH - Insulating sleeve

0201663

<https://www.phoenixcontact.com/us/products/0201663>

Insulating sleeve, color: white



MPS-IH RD - Insulating sleeve

0201676

<https://www.phoenixcontact.com/us/products/0201676>

Insulating sleeve, color: red



MACX MCR-SL-RPSS-2I-2I - Repeater power supply

2904089

<https://www.phoenixcontact.com/us/products/2904089>



MPS-IH BU - Insulating sleeve

0201689

<https://www.phoenixcontact.com/us/products/0201689>

Insulating sleeve, color: blue

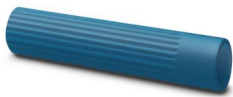

MPS-IH YE - Insulating sleeve

0201692

<https://www.phoenixcontact.com/us/products/0201692>

Insulating sleeve, color: yellow



MACX MCR-SL-RPSS-2I-2I - Repeater power supply

2904089

<https://www.phoenixcontact.com/us/products/2904089>



MPS-IH GN - Insulating sleeve

0201702

<https://www.phoenixcontact.com/us/products/0201702>

Insulating sleeve, color: green



MPS-IH GY - Insulating sleeve

0201728

<https://www.phoenixcontact.com/us/products/0201728>

Insulating sleeve, color: gray



MACX MCR-SL-RPSS-2I-2I - Repeater power supply

2904089

<https://www.phoenixcontact.com/us/products/2904089>



MPS-IH BK - Insulating sleeve

0201731

<https://www.phoenixcontact.com/us/products/0201731>

Insulating sleeve, color: black



MPS-MT - Test plug

0201744

<https://www.phoenixcontact.com/us/products/0201744>

Test plug, with solder connection up to 1 mm² conductor cross section, number of positions: 1, color: gray



MACX MCR-SL-RPSS-2I-2I - Repeater power supply



2904089

<https://www.phoenixcontact.com/us/products/2904089>

UC-EMLP (11X9) - Plastic label

0819291

<https://www.phoenixcontact.com/us/products/0819291>



Plastic label, Sheet, white, unlabeled, can be labeled with: BLUEMARK ID COLOR, BLUEMARK ID, BLUEMARK CLED, PLOTMARK, CMS-P1-PLOTTER, mounting type: adhesive, lettering field size: 11 x 9 mm, Number of individual labels: 10

UC-EMLP (11X9) YE - Plastic label

0822602

<https://www.phoenixcontact.com/us/products/0822602>

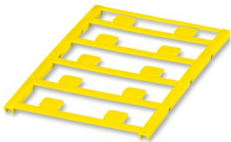

Plastic label, Sheet, yellow, unlabeled, can be labeled with: BLUEMARK ID COLOR, BLUEMARK ID, BLUEMARK CLED, PLOTMARK, CMS-P1-PLOTTER, mounting type: adhesive, lettering field size: 11 x 9 mm, Number of individual labels: 10

MACX MCR-SL-RPSS-2I-2I - Repeater power supply



2904089

<https://www.phoenixcontact.com/us/products/2904089>

UC-EMLP (11X9) CUS - Plastic label

0824547

<https://www.phoenixcontact.com/us/products/0824547>

Plastic label, can be ordered: by sheet, white, labeled according to customer specifications, mounting type: adhesive, lettering field size: 11 x 9 mm



UC-EMLP (11X9) YE CUS - Plastic label

0824548

<https://www.phoenixcontact.com/us/products/0824548>

Plastic label, can be ordered: by sheet, yellow, labeled according to customer specifications, mounting type: adhesive, lettering field size: 11 x 9 mm

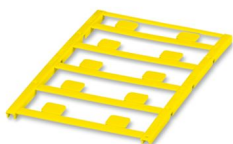

MACX MCR-SL-RPSS-2I-2I - Repeater power supply



2904089

<https://www.phoenixcontact.com/us/products/2904089>

UC-EMLP (11X9) SR - Plastic label

0828094

<https://www.phoenixcontact.com/us/products/0828094>



Plastic label, Sheet, silver, unlabeled, can be labeled with: BLUEMARK ID COLOR, BLUEMARK ID, BLUEMARK CLED, PLOTMARK, CMS-P1-PLOTTER, mounting type: adhesive, lettering field size: 11 x 9 mm, Number of individual labels: 10

UC-EMLP (11X9) SR CUS - Plastic label

0828098

<https://www.phoenixcontact.com/us/products/0828098>



Plastic label, can be ordered: by sheet, silver, labeled according to customer specifications, mounting type: adhesive, lettering field size: 11 x 9 mm, Number of individual labels: 10

MACX MCR-SL-RPSS-2I-2I - Repeater power supply



2904089

<https://www.phoenixcontact.com/us/products/2904089>

US-EMLP (11X9) - Plastic label

0828789

<https://www.phoenixcontact.com/us/products/0828789>



Plastic label, Card, white, unlabeled, can be labeled with: BLUEMARK ID COLOR, BLUEMARK ID, THERMOMARK PRIME, THERMOMARK CARD 2.0, THERMOMARK CARD, mounting type: adhesive, lettering field size: 11 x 9 mm, Number of individual labels: 135

US-EMLP (11X9) YE - Plastic label

0828871

<https://www.phoenixcontact.com/us/products/0828871>



Plastic label, Card, yellow, unlabeled, can be labeled with: BLUEMARK ID COLOR, BLUEMARK ID, THERMOMARK PRIME, THERMOMARK CARD 2.0, THERMOMARK CARD, mounting type: adhesive, lettering field size: 11 x 9 mm, Number of individual labels: 135

MACX MCR-SL-RPSS-2I-2I - Repeater power supply



2904089

<https://www.phoenixcontact.com/us/products/2904089>

US-EMLP (11X9) SR - Plastic label

0828872

<https://www.phoenixcontact.com/us/products/0828872>



Plastic label, Card, silver, unlabeled, can be labeled with: BLUEMARK ID COLOR, BLUEMARK ID, THERMOMARK PRIME, THERMOMARK CARD 2.0, THERMOMARK CARD, mounting type: adhesive, lettering field size: 11 x 9 mm, Number of individual labels: 135

LS-EMLP (11X9) WH - Device marker

0831678

<https://www.phoenixcontact.com/us/products/0831678>



Device marker, Sheet, white, unlabeled, can be labeled with: TOPMARK NEO, TOPMARK LASER, mounting type: adhesive, lettering field size: 11 x 9 mm, Number of individual labels: 255

MACX MCR-SL-RPSS-2I-2I - Repeater power supply



2904089

<https://www.phoenixcontact.com/us/products/2904089>

LS-EMLP (11X9) SR - Device marker

0831705

<https://www.phoenixcontact.com/us/products/0831705>

Device marker, Sheet, silver, unlabeled, can be labeled with: TOPMARK NEO, TOPMARK LASER, mounting type: adhesive, lettering field size: 11 x 9 mm, Number of individual labels: 255



LS-EMLP (11X9) YE - Device marker

0831732

<https://www.phoenixcontact.com/us/products/0831732>

Device marker, Sheet, yellow, unlabeled, can be labeled with: TOPMARK NEO, TOPMARK LASER, mounting type: adhesive, lettering field size: 11 x 9 mm, Number of individual labels: 255

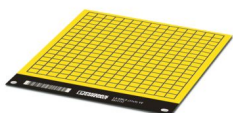

MACX MCR-SL-RPSS-2I-2I - Repeater power supply



2904089

<https://www.phoenixcontact.com/us/products/2904089>

MACX MCR-PTB - Power and error message module

2865625

<https://www.phoenixcontact.com/us/products/2865625>



Power and fault signaling module with screw connection, including corresponding ME 17,5 TBUS 1,5/ 5-ST-3,81 GY DIN rail connector

MACX MCR-PTB-SP - Power and error message module

2924184

<https://www.phoenixcontact.com/us/products/2924184>



Power and fault signaling module with Push-in connection, including corresponding ME 17,5 TBUS 1,5/ 5-ST-3,81 GY DIN rail connector

MACX MCR-SL-RPSS-2I-2I - Repeater power supply

2904089

<https://www.phoenixcontact.com/us/products/2904089>



QUINT4-SYS-PS/1AC/24DC/2.5/SC - Power supply unit

2904614

<https://www.phoenixcontact.com/us/products/2904614>



Primary-switched power supply, QUINT POWER, screw connection, DIN rail mounting, supply of devices possible via the TBUS DIN rail connector, protective coating, input: single-phase, output: 24 V DC/2.5 A

SZS 0,6X3,5 - Screwdriver

1205053

<https://www.phoenixcontact.com/us/products/1205053>



Actuation tool, for ST terminal blocks, insulated, also suitable for use as a bladed screwdriver, size: 0.6 x 3.5 x 100 mm, 2-component grip, with non-slip grip

MACX MCR-SL-RPSS-2I-2I - Repeater power supply

2904089

<https://www.phoenixcontact.com/us/products/2904089>



MACX SET-TVFKC 2-POLE - Connector set

1584383

<https://www.phoenixcontact.com/us/products/1584383>

TVFKC plug set for MACX, not Ex i devices, with 2-pos. plugs



Phoenix Contact 2024 © - all rights reserved

<https://www.phoenixcontact.com>

Phoenix Contact USA
586 Fulling Mill Road
Middletown, PA 17057, United States
(+717) 944-1300
info@phoenixcon.com