

# Surface Mount Common Mode Choke

NCC Series

## FEATURES

- HIGH COMMON MODE IMPEDANCE AT HIGH FREQUENCY
- LOW PROFILE SURFACE MOUNT PACKAGE
- SHIELDED PROVIDING EXCELLENT NOISE SUPPRESSION
- SUITABLE FOR HIGH SPEED DIGITAL EQUIPMENT (USB/IEEE)
- Pb-FREE CONSTRUCTION
- BOTH FLOW AND REFLOW SOLDERING APPLICABLE

## CHARACTERISTICS

Case Size	0805	1206
Impedance Range	30~ 370 Ohms	30 ~ 2,200 Ohms
Available Tolerance	±25%	
Temperature Range	-40°C ~ +125°C	
Withstanding voltage	125VDC 30 seconds	
Insulation Resistance	10MΩ after application 50V for 30 seconds	
Resistance to Solder Heat	260°C ±5°C for 10 seconds	
Temperature Cycling	±25% of initial value after 10 cycles (-40°C/+20°C/+125°C/+20°C)	

## NCC0805 SPECIFICATIONS

NIC Part Number	Impedance (Ω)	Test Frequency (MHz)	DC Resistance (Ω max.)	DC Current (mA max.)	Voltage Rating (Vdc)	Withstanding Voltage (Vdc)	Insulation Resistance (Ω)
NCC0805F300KTRF	30 ±25%	100	0.2	400	50	125	10Meg
NCC0805F670KTRF	67 ±25%		0.25	400			
NCC0805F900KTRF	90 ±25%		0.3	400			
NCC0805F121KTRF	120 ±25%		0.3	400			
NCC0805F161JTRF	160 ±25%		0.35	350			
NCC0805F181JTRF	180 ±25%		0.35	350			
NCC0805F221HTRF	220 ±25%		0.4	300			
NCC0805F221MTRF	220 ±25%		0.4	600			
NCC0805F261HTRF	260 ±25%		0.4	300			
NCC0805F301HTRF	300 ±25%		0.45	300			
NCC0805F361FTRF	360 ±25%		0.5	100			
NCC0805F371FTRF	370 ±25%		0.5	100			

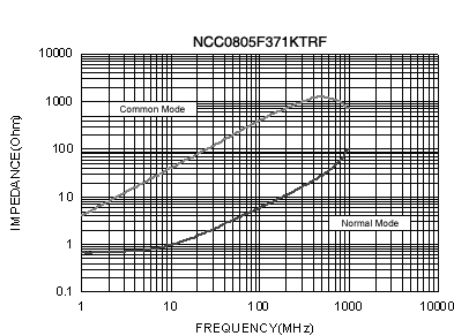
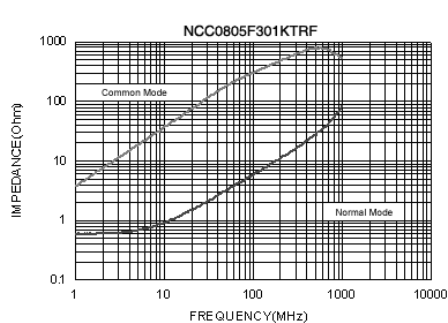
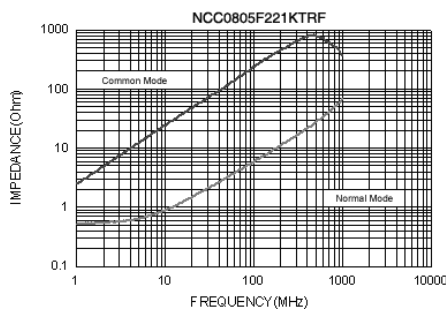
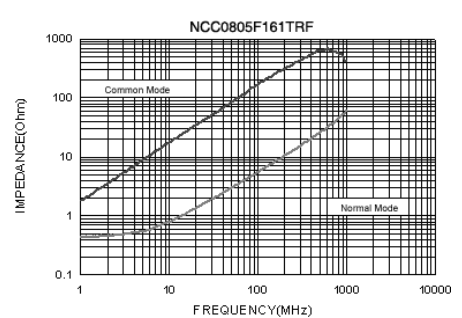
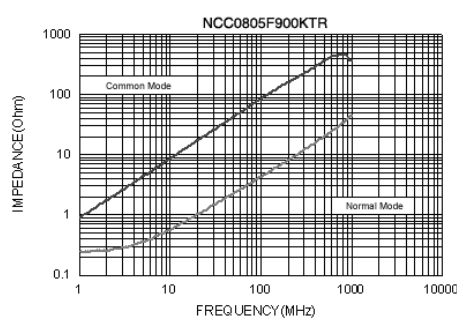
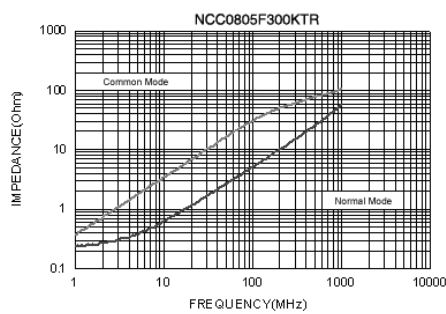

**RoHS Compliant**

includes all homogeneous materials



\*See Part Number System for Details

## PART NUMBER SYSTEM

NCC 0805 F 300 K TR E

Series | Case Code | Material (Ferrite) | Impedance value (ohms) | Current Rating | Tape & Reel | Pb-free/RoHS Compliant



### NCC1206 SPECIFICATIONS

NIC Part Number	Impedance ( $\Omega$ )	Test Frequency (MHz)	DC Resistance ( $\Omega$ max.)	DC Current (mA max.)	Voltage Rating (Vdc)	Withstanding Voltage (Vdc)	Insulation Resistance ( $\Omega$ )
NCC1206F300KTRF	30 $\pm$ 25%	100	0.2	400	50	125	10Meg
NCC1206F670KTRF	67 $\pm$ 25%		0.3	400			
NCC1206F800KTRF	80 $\pm$ 25%		0.3	400			
NCC1206F900KTRF	90 $\pm$ 25%		0.3	400			
NCC1206F121KTRF	120 $\pm$ 25%		0.3	400			
NCC1206F161JTRF	160 $\pm$ 25%		0.35	350			
NCC1206F181JTRF	180 $\pm$ 25%		0.35	350			
NCC1206F221HTRF	220 $\pm$ 25%		0.45	300			
NCC1206F261HTRF	260 $\pm$ 25%		0.45	300			
NCC1206F281HTRF	280 $\pm$ 25%		0.45	300			
NCC1206F301HTRF	300 $\pm$ 25%		0.5	300			
NCC1206F361HTRF	360 $\pm$ 25%		0.6	300			
NCC1206F431HTRF	430 $\pm$ 25%		0.6	300			
NCC1206F471HTRF	470 $\pm$ 25%		0.7	300			
NCC1206F551HTRF	550 $\pm$ 25%		0.75	300			
NCC1206F601HTRF	600 $\pm$ 25%		0.8	300			
NCC1206F222GTRF	2200 $\pm$ 25%		1.2	200			

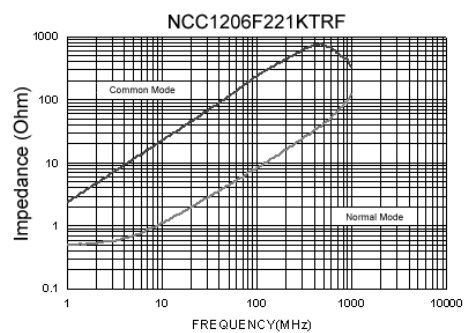
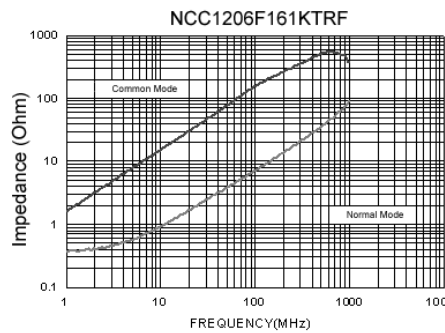
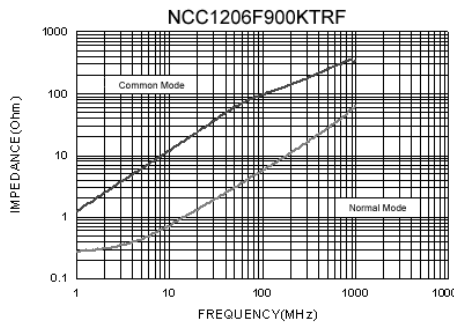

### CASE DIMENSIONS (mm)

Type	A $\pm$ 0.2	B $\pm$ 0.2	C $\pm$ 0.2	D1 $\pm$ 0.1	D2 $\pm$ 0.1	E $\pm$ 0.1
NCC0805	2.0	1.2	1.2	0.55	0.46	0.15
NCC1206	3.2	1.6	2.0	0.50	0.50	0.15

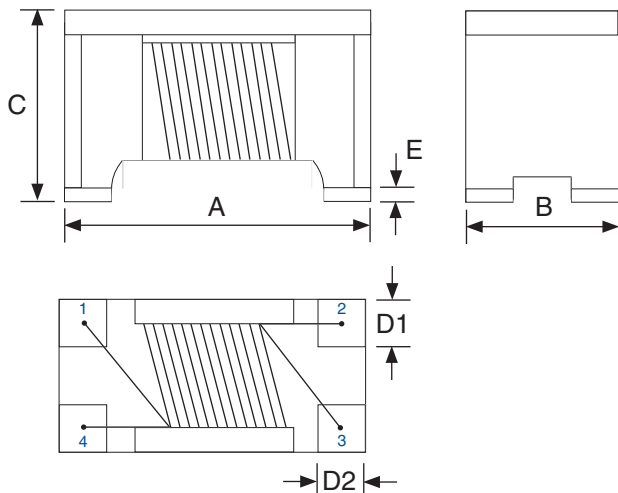

### CIRCUIT SCHEMATIC

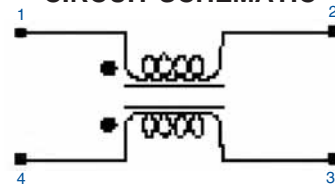

### LAND PATTERN DIMENSIONS (mm)

Case Size	L	W	T1	T2
0805	2.60	1.25	1.10	0.45
1206	3.70	1.60	1.90	0.40

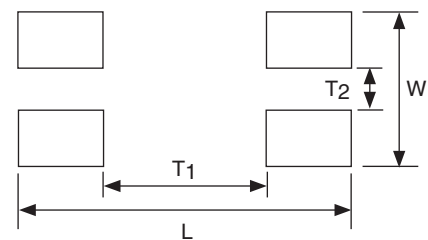

RECOMMENDED REFLOW SOLDERING PROFILE

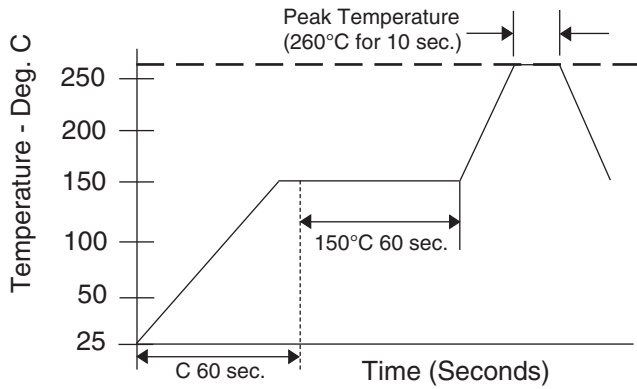

RECOMMENDED FLOW SOLDERING PROFILE

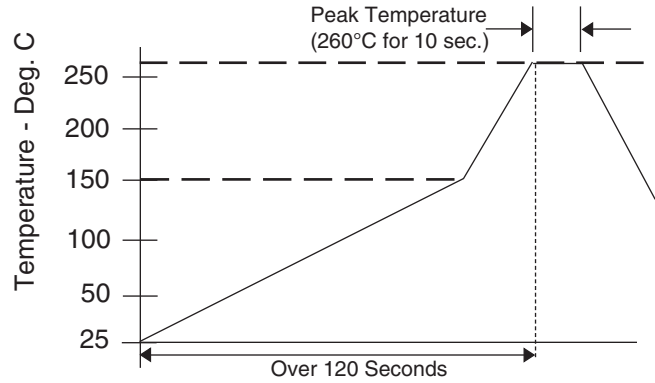

Series	A ± 0.1	B ± 0.1	E ± 0.1	F ± 0.05	P <sub>0</sub> ± 0.1	P <sub>1</sub> ± 0.1	D ± 0.1	W ± 0.1	t <sub>1</sub> ± 0.05	t <sub>2</sub> ± 0.1	Reel Quantity
NCC0805	1.50	2.35	1.75	3.5	4.0	4.0	1.5	8.0	0.22	1.45	2,000
NCC1206	1.88	3.50								2.10	

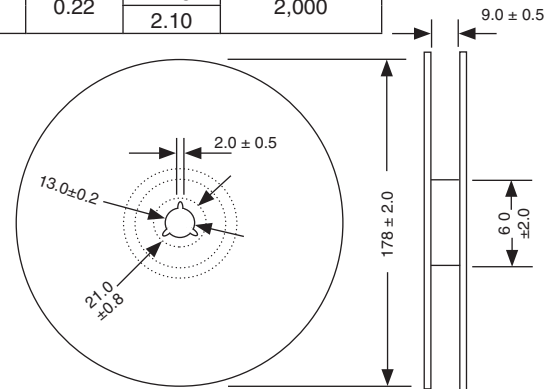
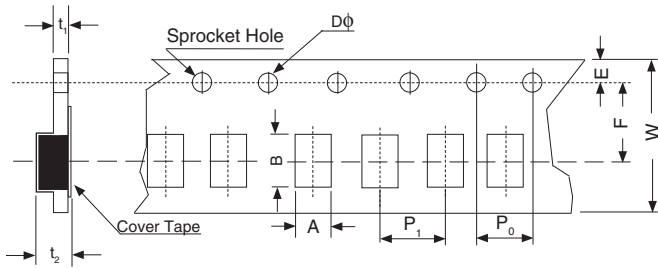

**REEL QUANTITY: 2,000 per reel**  
(0805 & 1206 case size)