

SCHOTTKY DIODES

Features

- ◆ Low forward voltage drop
- ◆ Guard ring construction for transient protection
- ◆ Negligible reverse recovery time

SOD-323



Mechanical Data

Case: JEDEC SOD-323 molded plastic body

Terminals: Plated leads solderable per MIL-STD-750, Method 2026

Polarity: Polarity symbols marked on case

Weight : 0.0007 ounce, 0.02 grams

Marking: SD103AWS:S4, SD103BWS:S5, SD103CWS:S6

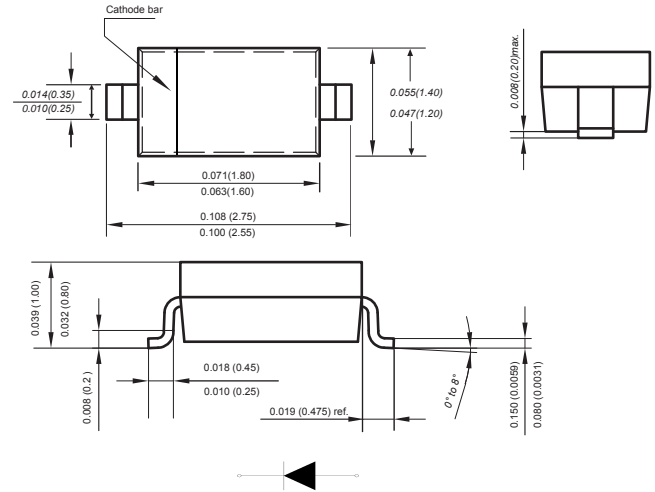

Dimensions in inches and (millimeters)

Absolute Maximum Ratings at 25 °C

PARAMETER	SYMBOLS	SD103AWS	SD103BWS	SD103CWS	UNITS
Peak repetitive peak reverse voltage	V_{RRM}				VOLTS
Working peak reverse voltage	V_{RMS}	40	30	20	
DC Blocking voltage	V_{DC}				
RMS Reverse voltage	$V_{R(RMS)}$	28	21	14	V
Forward continuous current	I_{FM}		350		mA
Repetitive peak forward current at $\leq 1.0s$	I_{FRM}		1.5		A
Power dissipation	P_d		200		mW
Thermal resistance junction to ambient	$R_{\theta JA}$		300		$^{\circ}C/W$
Storage temperature	T_{STG}		-55 to +150		$^{\circ}C$

Characteristics at $T_a = 25^{\circ}C$

PARAMETER	SYMBOLS	Min.	Typ.	Max.	Unit	Conditions
Reverse break down voltage	$V_{(BR)R}$	40			V	$I_R = 100\mu A$
Reverse voltage		30				
Reverse voltage		20				
Forward voltage	V_F			0.37 0.60	V	$I_F = 20mA$ $I_F = 200mA$
Reverse current	I_{RM}			5.0	μA	$V_R = 30V$ $V_R = 20V$ $V_R = 10V$
Capacitance between terminals	C_T		50		pF	$V_R = 0V, f = 1.0MHz$
Reverse recovery time	t_{rr}		10		ns	$I_F = I_R = 200mA$ $I_{rr} = 0.1 I_R, R_L = 100 \Omega$

Typical Characteristics

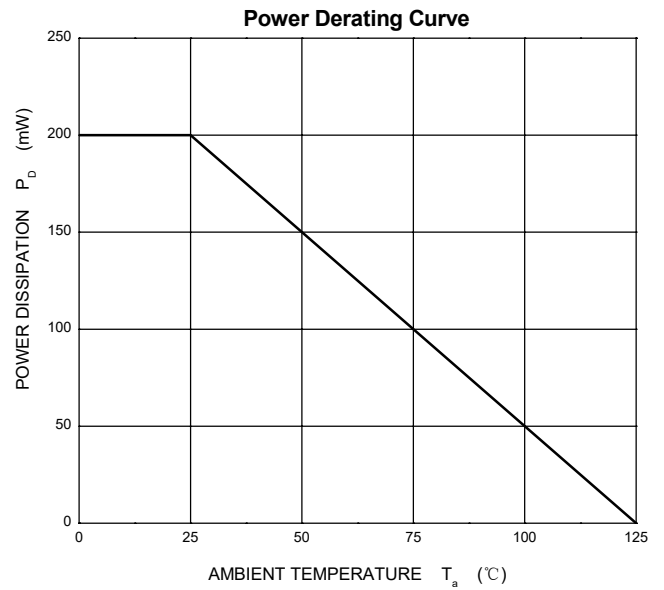
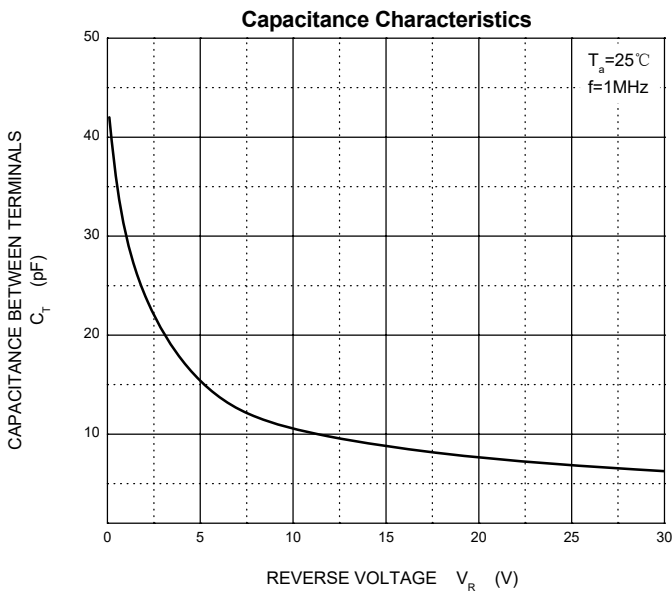
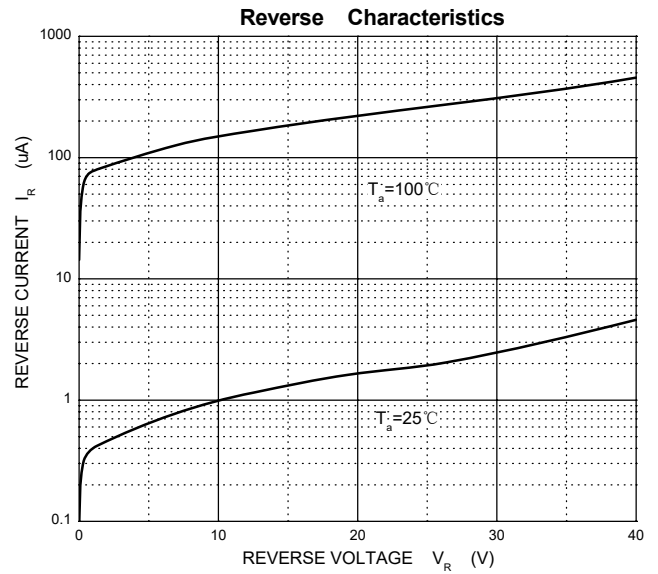
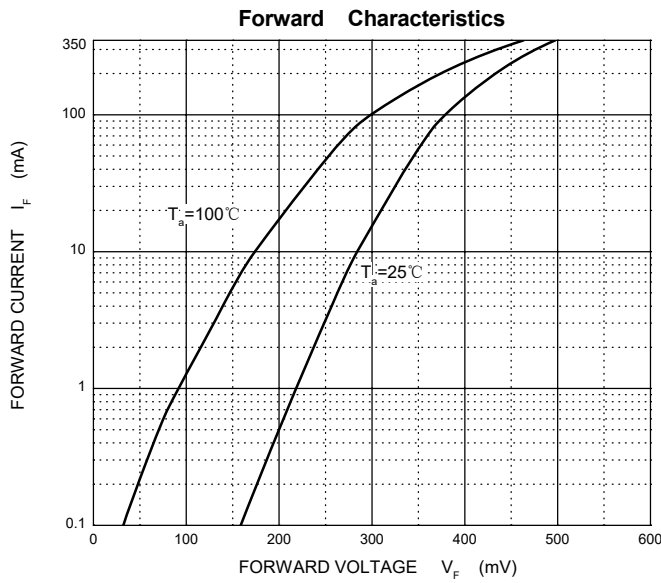

The curve above is for reference only.

Packing information

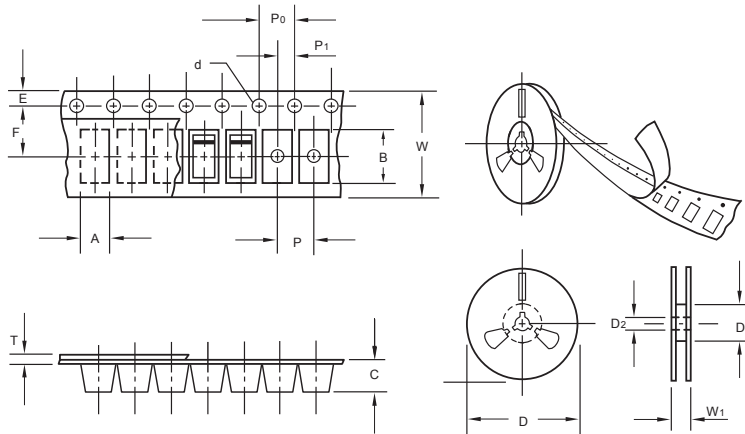

unit:mm

Item	Symbol	Tolerance	SOD-323
Carrier width	A	0.1	2.1
Carrier length	B	0.1	4.0
Carrier depth	C	0.1	1.60
Sprocket hole	d	0.05	1.55
7" Reel outside diameter	D	2.0	178.00
7" Reel inner diameter	D ₁	min	50.0
Feed hole diameter	D ₂	0.5	13.00
Sprocket hole position	E	0.1	1.75
Punch hole position	F	0.1	3.50
Punch hole pitch	P	0.1	4.00
Sprocket hole pitch	P ₀	0.1	4.00
Embossment center	P ₁	0.1	2.00
Overall tape thickness	T	0.1	0.25
Tape width	W	0.3	8.15
Reel width	W ₁	1.0	10.5

Note: Devices are packed in accordance with EIA standard RS-481-A and specifications listed above.

Reel packing

PACKAGE	REEL SIZE	REEL (pcs)	COMPONENT SPACING (m/m)	BOX (pcs)	INNER BOX (m/m)	REEL DIA, (m/m)	CARTON SIZE (m/m)	CARTON (pcs)	APPROX. GROSS WEIGHT (kg)
SOD-323	7"	3,000	4.0	45,000	210*208*203	178	430*430*235	180,000	

Suggested Pad Layout

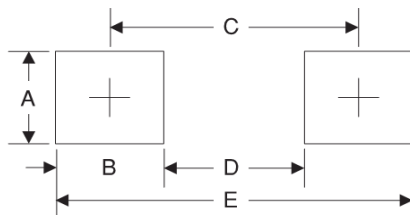

Symbol	Unit (mm)	Unit (inch)
A	0.7	0.028
B	0.7	0.028
C	2.15	0.085
D	1.8	0.071
E	2.85	0.112