

## Stepper motor EMMS-ST

**FESTO**

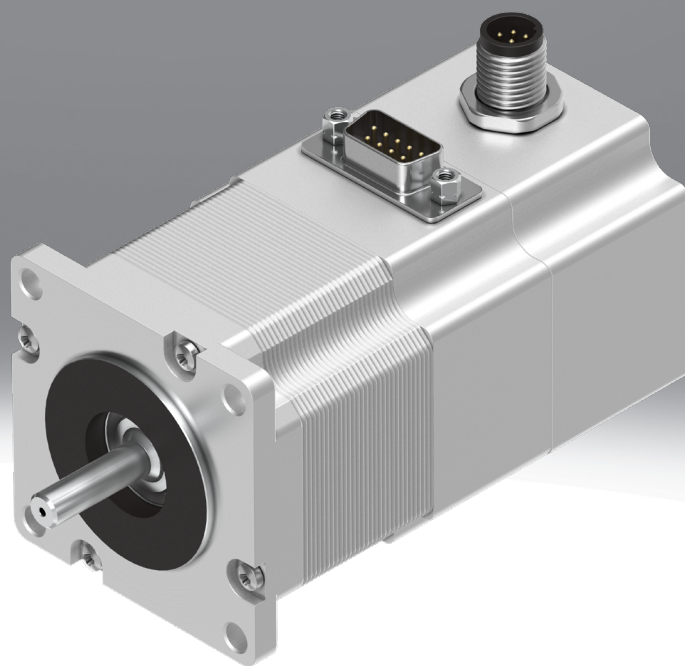

## Characteristics

### At a glance

- Conforms to standard IEC 60034
- 2-phase hybrid technology
- Sinusoidal current injection
- Degree of protection:  
IP54

Optional:

- Encoder
- Holding brake

### Product segmentation



Festo Core Range

Solves the majority of your automation tasks

With the Festo Core Range, we have selected the most important products and functions from our broad product catalogue, and added the quickest delivery. The Core Range offers you the best value with the expected high Festo quality.

- Quickest delivery, worldwide – wherever, whenever
- Expected high Festo quality
- Easy and fast to select

### Engineering tools

[Further information → electric motion sizing](#)



Save time with engineering tools Smart Engineering for the optimal solution. Our goal is to increase your productivity. Our engineering tools play an integral part in this. They help you size your system correctly, tap into unimagined productivity reserves and generate additional productivity along the entire value chain. In every phase of your project, from the initial contact to the modernisation of your machine, you will come across a number of different tools which will be of use to you.

### Diagrams

[Further information → emms-st](#)



The diagrams shown in this document are also available online. These can be used to display precise values.

### Brake

The holding brake should not be used as a safety brake.

## Type code

001	Series	
EMMS	Motor	

002	Motor type	
ST	Stepper motor ST	

003	Flange size, motors [mm]	
28	28	
42	42	
57	57	
87	87	

004	Length	
L	Long	
M	Medium	
S	Short	

005	Electrical connection	
S	Straight plug	

006	Measuring unit	
	None	
E	Encoder	

007	Brake	
	None	
B	With brake	

008	Generation	
	1st generation	
G2	2nd generation	

## Datasheet

General technical data							
Flange size, motors [mm]	28	42	57		87		
Length	Long	Short	Medium	Short	Long	Medium	Short
Nominal operating voltage DC	48 V						
Nominal motor current	1.4 A	1.8 A	5 A		9.5 A		
Max. rotational speed <sup>1)</sup>	6,000 rpm	1,740 rpm	1,940 rpm	2,720 rpm	430 rpm	550 rpm	2,130 rpm
Motor holding torque	0.09 Nm	0.5 Nm	1.4 Nm	0.8 Nm	9.3 Nm	5.9 Nm	2.5 Nm
Voltage constant, phase	6 mVmin	23 mVmin	25.5 mVmin	12 mVmin	77.2 mVmin	68.6 mVmin	19 mVmin
Stepper angle for complete step	1.8 deg						
Stepping angle tolerance	±5%						
Phase winding resistance	2.3 Ohm	1.75 Ohm	0.25 Ohm	0.15 Ohm	0.23 Ohm		0.1 Ohm
Phase winding inductance	1.4 mH	3.3 mH	0.95 mH	0.5 mH	2.7 mH	2.6 mH	0.45 mH
Total mass moment of inertia of output <sup>2)</sup>	0.018 kgcm <sup>2</sup> ; 0.025 kgcm <sup>2</sup>	0.082 kgcm <sup>2</sup> ; 0.095 kgcm <sup>2</sup>	0.48 kgcm <sup>2</sup> ; 0.5 kgcm <sup>2</sup>	0.29 kgcm <sup>2</sup> ; 0.3 kgcm <sup>2</sup>	3 kgcm <sup>2</sup> ; 3.07 kgcm <sup>2</sup>	1.9 kgcm <sup>2</sup> ; 1.97 kgcm <sup>2</sup>	1 kgcm <sup>2</sup> ; 1.07 kgcm <sup>2</sup>
Permissible radial shaft load	20 N		52 N		200 N		
Permissible axial shaft load	7 N		10 N		65 N		
Mass moment of inertia of rotor	0.018 kgcm <sup>2</sup>	0.082 kgcm <sup>2</sup>	0.48 kgcm <sup>2</sup>	0.29 kgcm <sup>2</sup>	3 kgcm <sup>2</sup>	1.9 kgcm <sup>2</sup>	1 kgcm <sup>2</sup>
Operating voltage DC for brake	24 V						
Power consumption, brake	8 W		10 W	8 W	11 W		
Brake holding torque	0.2 Nm	0.4 Nm	1 Nm	0.4 Nm	2 Nm		
Mass moment of inertia of brake	0.007 kgcm <sup>2</sup>	0.013 kgcm <sup>2</sup>	0.02 kgcm <sup>2</sup>	0.01 kgcm <sup>2</sup>	0.07 kgcm <sup>2</sup>		

1) Theoretical max. rotational speed at nominal voltage when idling.

2) Without brake/with brake

Technical data – Encoder				
Flange size, motors [mm]	28	42	57	87
Rotor position sensor	Incremental encoder			
Rotor position sensor, encoder measuring principle	Optical			
Rotor position encoder interface	RS422 TTL AB channels + zero index			

Weight							
Flange size, motors [mm]	28	42	57		87		
Length	Long	Short	Medium	Short	Long	Medium	Short
Product weight <sup>1)</sup>	268 g; 295 g; 356 g; 383 g	360 g; 450 g; 540 g; 600 g	1,100 g; 1,200 g; 1,320 g; 1,380 g	870 g; 970 g; 1,090 g; 1,150 g	4,200 g; 4,350 g; 4,600 g; 5,000 g	3,050 g; 3,200 g; 3,450 g; 3,600 g	1,950 g; 2,100 g; 2,350 g; 2,500 g

1) Product weight / With encoder / With brake / With encoder and brake

## Datasheet

## Operating and ambient conditions

Flange size, motors [mm]	28	42	57	87
Conforms to standard	IEC 60034			
Insulation protection class	B			
Temperature class as per EN 60034-1	B			
Rating class as per EN 60034-1	S1			
Degree of protection	IP65	IP54		
Ambient temperature	-10 ... 50°C			
Storage temperature	-20 ... 70°C			
Relative air humidity	0 - 85%			
CE mark (see declaration of conformity) <sup>1)</sup>	To EU EMC Directive In accordance with EU RoHS Directive			
CE marking (see declaration of conformity) <sup>2)</sup>	To UK instructions for EMC To UK RoHS instructions			
Approval	RCM trademark c UL us - Recognized (OL)			
LABS (PWIS) conformity	VDMA24364-B2-L			
Note on materials	RoHS-compliant			

1) Further information [www.festo.com/catalogue/...](http://www.festo.com/catalogue/...) → Support/Downloads.

2) Further information [www.festo.com/catalogue/...](http://www.festo.com/catalogue/...) → Support/Downloads.

## Torque M as a function of rotational speed n for EMMS-ST-28, long

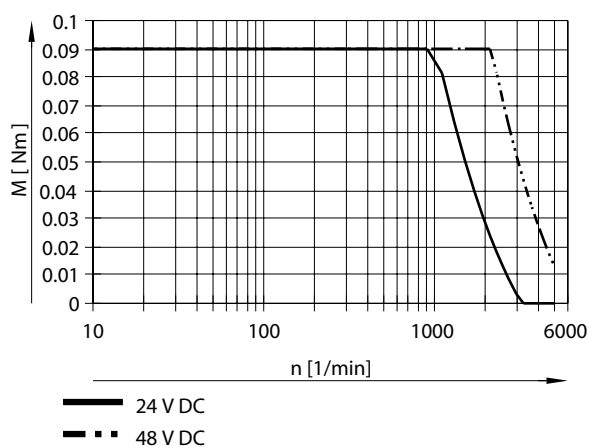

Typical motor characteristic curve (typical production tolerances  $\pm 20\%$ ) at nominal voltage and optimal motor controller.

## Torque M as a function of rotational speed n for EMMS-ST-42, short

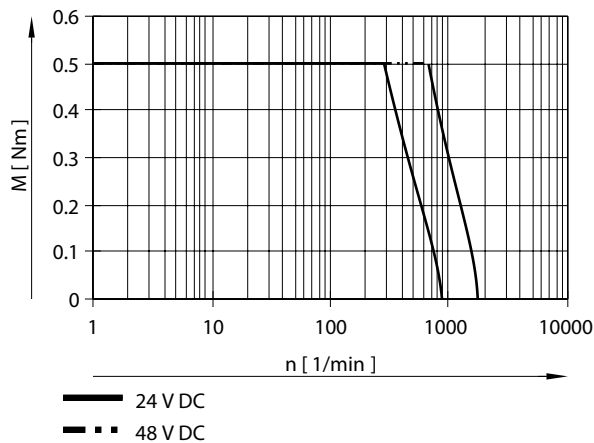

Typical motor characteristic curve (typical production tolerances  $\pm 20\%$ ) at nominal voltage and optimal motor controller.

Datasheet

Torque M as a function of rotational speed n for EMMS-ST-57, short

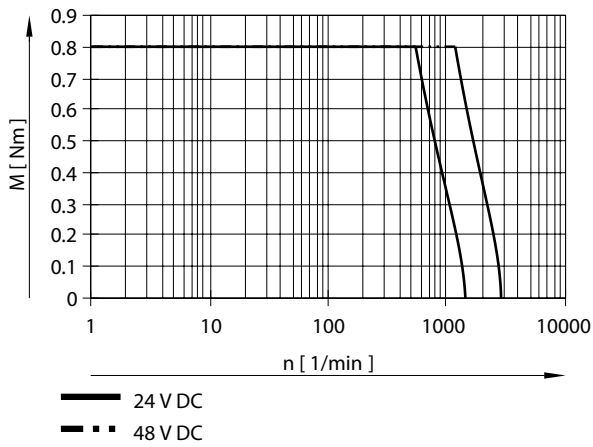

Typical motor characteristic curve (typical production tolerances  $\pm 20\%$ ) at nominal voltage and optimal motor controller.

Torque M as a function of rotational speed n for EMMS-ST-57, medium

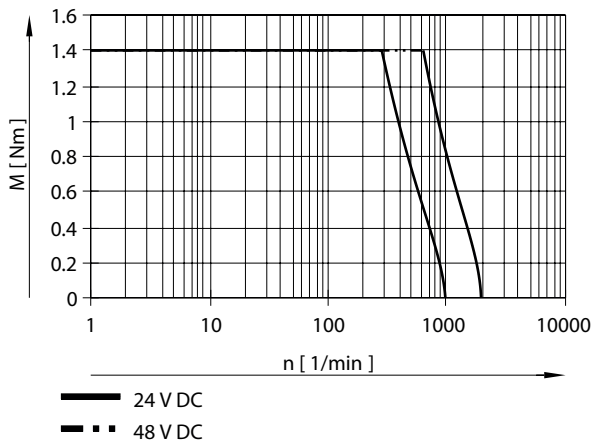

Typical motor characteristic curve (typical production tolerances  $\pm 20\%$ ) at nominal voltage and optimal motor controller.

Torque M as a function of rotational speed n for EMMS-ST-87, short

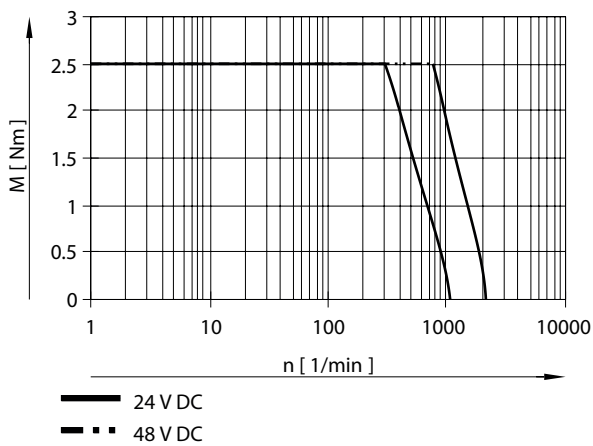

Typical motor characteristic curve (typical production tolerances  $\pm 20\%$ ) at nominal voltage and optimal motor controller.

## Datasheet

## Torque M as a function of rotational speed n for EMMS-ST-87, medium

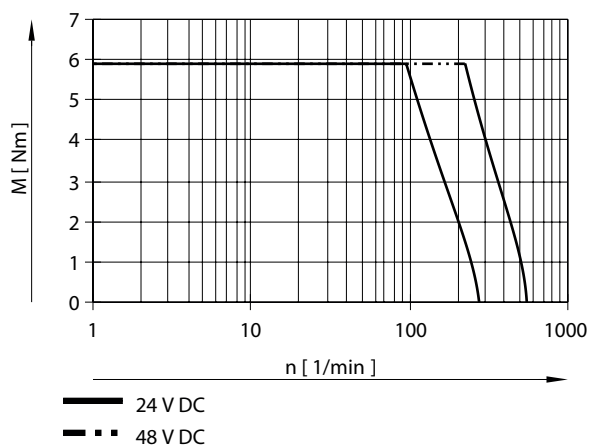

Typical motor characteristic curve (typical production tolerances  $\pm 20\%$ ) at nominal voltage and optimal motor controller.

## Torque M as a function of rotational speed n for EMMS-ST-87, long

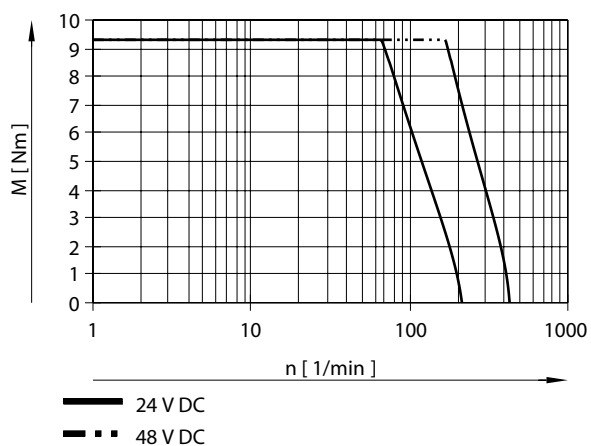

Typical motor characteristic curve (typical production tolerances  $\pm 20\%$ ) at nominal voltage and optimal motor controller.

## Dimensions

Dimensions – Stepper motors EMMS-ST...-SB/SEB, size 28

Download CAD data → [www.festo.com](http://www.festo.com)

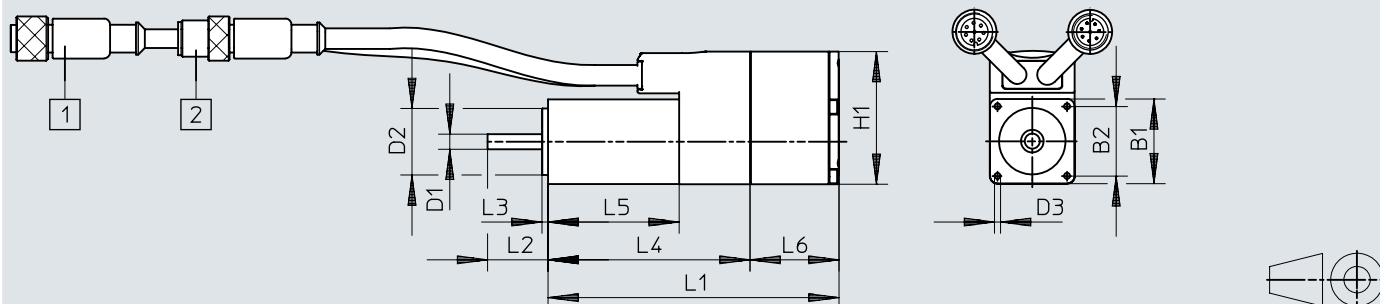

- [1] Motor cable
- [2] Encoder cable

	B1	B2	D1 ∅	D2 ∅	D3	H1	L1	L2	L3	L4	L5	L6
	±1	±0,2	-0,013	-0,03				±1		±1	±1	±0,5
EMMS-ST-28-L-SB	28	23	5	22	M2,5x4,5	44	96±1,5	20	2	67	43	29
EMMS-ST-28-L-SEB												



## Dimensions

### Dimensions – Stepper motors EMMS-ST-...-S/SE, size 28

Download CAD data → [www.festo.com](http://www.festo.com)

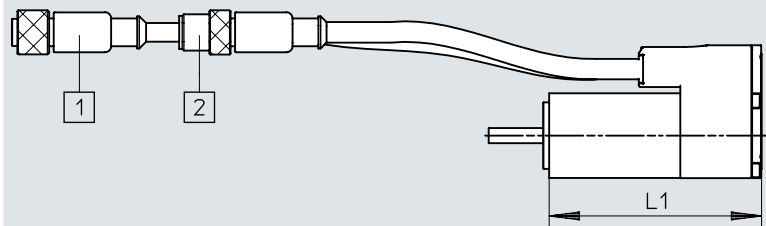

- [1] Motor cable
- [2] Encoder cable

	L1
EMMS-ST-28-L-S	70±1
EMMS-ST-28-L-SE	

## Dimensions

Dimensions – EMMS-ST-...-SE/SEB, size 42, 57, 87

Download CAD data → [www.festo.com](http://www.festo.com)

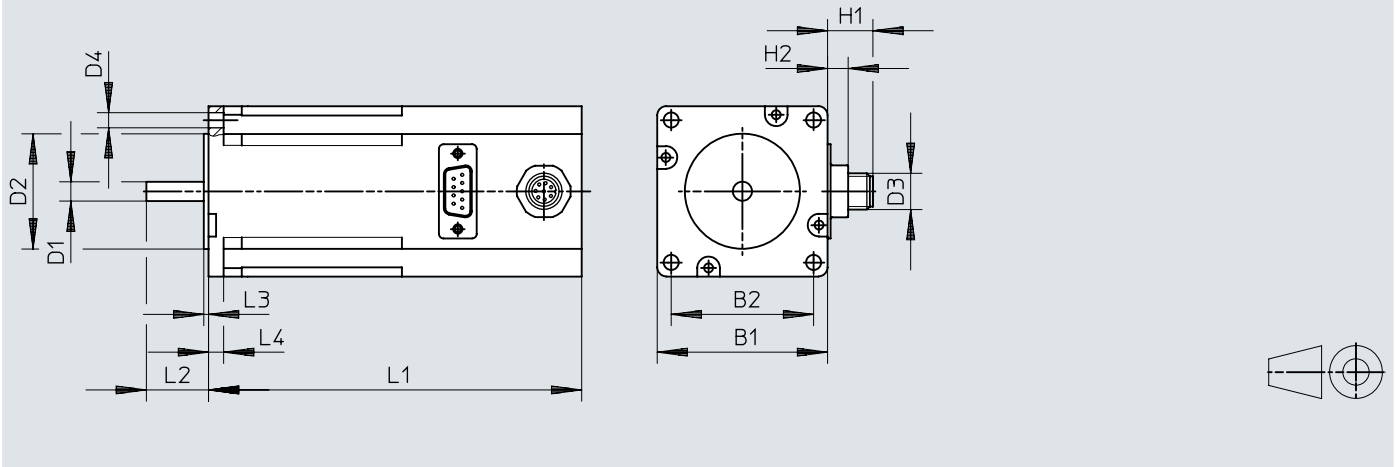

	B1	B2 ±0,2	D1 ∅	D2 ∅	D3	D4 ∅
EMMS-ST-42-S-SE-G2	42,3	31	5-0,012	22-0,05	M12	M3x4,5
EMMS-ST-42-S-SEB-G2					M12	
EMMS-ST-57-S-SE-G2	56,4	47,14	6,35-0,013	38,1±0,025	M12	5
EMMS-ST-57-S-SEB-G2					M12	
EMMS-ST-57-M-SE-G2					M12	
EMMS-ST-57-M-SEB-G2					M12	
EMMS-ST-87-S-SE-G2	85,85	69,5	11-0,013	73-0,046	M12	6,6
EMMS-ST-87-S-SEB-G2					M12	
EMMS-ST-87-M-SE-G2					M12	
EMMS-ST-87-M-SEB-G2					M12	
EMMS-ST-87-L-SE-G2					M12	
EMMS-ST-87-L-SEB-G2					M12	

	H1	H2	L1	L2	L3	L4
EMMS-ST-42-S-SE-G2	13	6,5	94±1,2	24±1	2	-
EMMS-ST-42-S-SEB-G2	13		127±1,3			
EMMS-ST-57-S-SE-G2	13		102,5±1,1	20,6±0,5	1,6	5
EMMS-ST-57-S-SEB-G2	13		138±1,1			
EMMS-ST-57-M-SE-G2	13		124±1,1			
EMMS-ST-57-M-SEB-G2	13		159,5±1,1			
EMMS-ST-87-S-SE-G2	13		112,6±1,3	27±1	2	8,38
EMMS-ST-87-S-SEB-G2	13		152,6±1,3			
EMMS-ST-87-M-SE-G2	13		144,9±1,3			
EMMS-ST-87-M-SEB-G2	13		184,9±1,3			
EMMS-ST-87-L-SE-G2	13		174,9±1,3			
EMMS-ST-87-L-SEB-G2	13		214,9±1,3			

## Dimensions

Dimensions – EMMS-ST-...-S, size 42, 57, 87

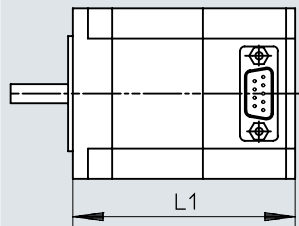
Download CAD data → [www.festo.com](http://www.festo.com)

	L1
EMMS-ST-42-S-S-G2	66±1
EMMS-ST-57-S-S-G2	73,5±0,8
EMMS-ST-57-M-S-G2	95±0,8
EMMS-ST-87-S-S-G2	82,6±1
EMMS-ST-87-M-S-G2	114,9±1
EMMS-ST-87-L-S-G2	144,9±1

## Dimensions

Dimensions – EMMS-ST-...-SB, size 42, 57, 87

Download CAD data → [www.festo.com](http://www.festo.com)

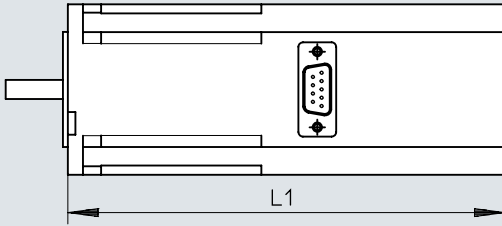

	L1
EMMS-ST-42-S-SB-G2	114±1,3
EMMS-ST-57-S-SB-G2	123,5±1,1
EMMS-ST-57-M-SB-G2	145±1,1
EMMS-ST-87-S-SB-G2	132,6±1,3
EMMS-ST-87-M-SB-G2	164,9±1,3
EMMS-ST-87-L-SB-G2	194,9±1,3

## Ordering data

Ordering data								
	Flange size, motors [mm]	Length	Measuring unit	Brake	Part no.	Type		
	28 mm	Long	None	None	★ 1451384	EMMS-ST-28-L-S		
				With brake	★ 1451383	EMMS-ST-28-L-SB		
			Encoder	None	★ 1430663	EMMS-ST-28-L-SE		
				With brake	★ 1451382	EMMS-ST-28-L-SEB		
	42 mm	Short	None	None	★ 1370470	EMMS-ST-42-S-S-G2		
				With brake	★ 1370472	EMMS-ST-42-S-SB-G2		
			Encoder	None	★ 1370471	EMMS-ST-42-S-SE-G2		
				With brake	★ 1370473	EMMS-ST-42-S-SEB-G2		
			57 mm	Medium	None	None	★ 1370478	EMMS-ST-57-M-S-G2
						With brake	★ 1370480	EMMS-ST-57-M-SB-G2
	Encoder	None			★ 1370479	EMMS-ST-57-M-SE-G2		
		With brake			★ 1370481	EMMS-ST-57-M-SEB-G2		
	Short	None		None	★ 1370474	EMMS-ST-57-S-S-G2		
				With brake	★ 1370476	EMMS-ST-57-S-SB-G2		
		Encoder		None	★ 1370475	EMMS-ST-57-S-SE-G2		
				With brake	★ 1370477	EMMS-ST-57-S-SEB-G2		
	87 mm	Long	None	None	★ 1370490	EMMS-ST-87-L-S-G2		
				With brake	★ 1370493	EMMS-ST-87-L-SB-G2		
			Encoder	None	★ 1370491	EMMS-ST-87-L-SE-G2		
				With brake	★ 1370494	EMMS-ST-87-L-SEB-G2		
			Medium	None	None	★ 1370486	EMMS-ST-87-M-S-G2	
					With brake	★ 1370488	EMMS-ST-87-M-SB-G2	
		Encoder		None	★ 1370487	EMMS-ST-87-M-SE-G2		
				With brake	★ 1370489	EMMS-ST-87-M-SEB-G2		
		Short	None	None	★ 1370482	EMMS-ST-87-S-S-G2		
				With brake	★ 1370484	EMMS-ST-87-S-SB-G2		
			Encoder	None	★ 1370483	EMMS-ST-87-S-SE-G2		
				With brake	★ 1370485	EMMS-ST-87-S-SEB-G2		

## Accessories

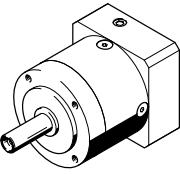
Planetary gear					
	Gear unit ratio	Note on materials	Product weight	Part no.	Type
	3:1	RoHS-compliant	350 g	★ 549428	EMGA-40-P-G3-SST-42
	5:1			★ 549429	EMGA-40-P-G5-SST-42
	8:1		400 g	8141762	EMGA-40-P-G8-SST-42
	12:1		450 g	8141763	EMGA-40-P-G12-SST-42

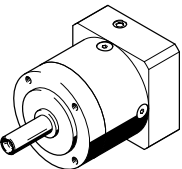
Planetary gear					
	Gear unit ratio	Note on materials	Product weight	Part no.	Type
	3:1	RoHS-compliant	900 g	★ 549430	EMGA-60-P-G3-SST-57
	5:1			★ 549431	EMGA-60-P-G5-SST-57
	8:1			8141764	EMGA-60-P-G8-SST-57
	12:1		1,100 g	8141765	EMGA-60-P-G12-SST-57

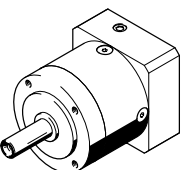
Planetary gear					
	Gear unit ratio	Note on materials	Product weight	Part no.	Type
	3:1	RoHS-compliant	2,100 g	★ 549432	EMGA-80-P-G3-SST-87
	5:1			★ 549433	EMGA-80-P-G5-SST-87
	8:1			8141766	EMGA-80-P-G8-SST-87
	12:1		2,600 g	8141767	EMGA-80-P-G12-SST-87

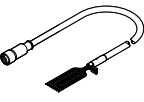
Motor cable for EMMS-ST-28 and motor controller CMMT-ST: straight plug						
	Bending radius, moving cable	Cable characteristic	Ambient temperature	Cable length <sup>1)</sup>	Part no.	Type
	62 mm	Suitable for energy chains	-40 ... 80 °C	1 ... 25 m	1449605	NEBM-SM12G8-E-Q5-LE6
				1.5 m	★ 1449600	NEBM-SM12G8-E-1.5-Q5-LE6
				2.5 m	★ 1449601	NEBM-SM12G8-E-2.5-Q5-LE6
				5 m	★ 1449602	NEBM-SM12G8-E-5-Q5-LE6
				7 m	★ 1449603	NEBM-SM12G8-E-7-Q5-LE6
				10 m	★ 1449604	NEBM-SM12G8-E-10-Q5-LE6

1) Maximum 25 m. Available in 0.1 m increments.

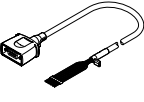
Motor cable for EMMS-ST-42/57 and motor controller CMMT-ST/CMMS-ST: straight plug						
	Bending radius, moving cable	Cable characteristic	Ambient temperature	Cable length <sup>1)</sup>	Part no.	Type
	62 mm	Suitable for energy chains	-40 ... 80 °C	1 ... 25 m	1450373	NEBM-S1G9-E-Q5-LE6
				1.5 m	★ 1450368	NEBM-S1G9-E-1.5-Q5-LE6
				2.5 m	★ 1450369	NEBM-S1G9-E-2.5-Q5-LE6
				5 m	★ 1450370	NEBM-S1G9-E-5-Q5-LE6
				7 m	★ 1450371	NEBM-S1G9-E-7-Q5-LE6
				10 m	★ 1450372	NEBM-S1G9-E-10-Q5-LE6

1) Maximum 25 m. Available in 0.1 m increments.

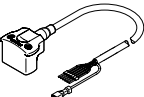
Motor cable for EMMS-ST-42/57 and motor controller CMMT-ST/CMMS-ST: angled plug						
	Bending radius, moving cable	Cable characteristic	Ambient temperature	Cable length <sup>1)</sup>	Part no.	Type
	62 mm	Suitable for energy chains	-40 ... 80 °C	1 ... 25 m	1450741	NEBM-S1W9-E-Q5-LE6

## Accessories

**Motor cable for EMMS-ST-42/57 and motor controller CMMT-ST/CMMS-ST: angled plug**

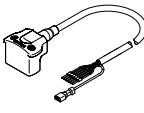
	Bending radius, moving cable	Cable characteristic	Ambient temperature	Cable length <sup>1)</sup>	Part no.	Type
	62 mm	Suitable for energy chains	-40 ... 80 °C	1.5 m	★ 1450736	NEBM-S1W9-E-1.5-Q5-LE6
				2.5 m	★ 1450737	NEBM-S1W9-E-2.5-Q5-LE6
				5 m	★ 1450738	NEBM-S1W9-E-5-Q5-LE6
				7 m	★ 1450739	NEBM-S1W9-E-7-Q5-LE6
				10 m	★ 1450740	NEBM-S1W9-E-10-Q5-LE6

1) Maximum 25 m. Available in 0.1 m increments.

Angled cables and leads can protrude into the area of the axis/drive.

**Motor cable for EMMS-ST-87 and motor controller CMMT-ST/CMMS-ST: straight plug**

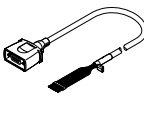
	Bending radius, moving cable	Cable characteristic	Ambient temperature	Cable length <sup>1)</sup>	Part no.	Type
	80 mm	Suitable for energy chains	-40 ... 80 °C	1 ... 25 m	1450839	NEBM-S1G15-E-Q7-LE6
				1.5 m	★ 1450834	NEBM-S1G15-E-1.5-Q7-LE6
				2.5 m	★ 1450835	NEBM-S1G15-E-2.5-Q7-LE6
				5 m	★ 1450836	NEBM-S1G15-E-5-Q7-LE6
				7 m	★ 1450837	NEBM-S1G15-E-7-Q7-LE6
				10 m	★ 1450838	NEBM-S1G15-E-10-Q7-LE6

1) Maximum 25 m. Available in 0.1 m increments.

**Motor cable for EMMS-ST-87 and motor controller CMMT-ST/CMMS-ST: angled plug**

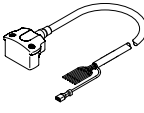
	Bending radius, moving cable	Cable characteristic	Ambient temperature	Cable length <sup>1)</sup>	Part no.	Type
	80 mm	Suitable for energy chains	-40 ... 80 °C	1 ... 25 m	1450948	NEBM-S1W15-E-Q7-LE6
				1.5 m	★ 1450943	NEBM-S1W15-E-1.5-Q7-LE6
				2.5 m	★ 1450944	NEBM-S1W15-E-2.5-Q7-LE6
				5 m	★ 1450945	NEBM-S1W15-E-5-Q7-LE6
				7 m	★ 1450946	NEBM-S1W15-E-7-Q7-LE6
				10 m	★ 1450947	NEBM-S1W15-E-10-Q7-LE6

1) Maximum 25 m. Available in 0.1 m increments.

Angled cables and leads can protrude into the area of the axis/drive.

**Encoder cable for motor controller CMMS-ST: straight connector**

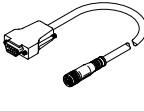
	Bending radius, moving cable	Cable characteristic	Ambient temperature	Cable length <sup>1)</sup>	Part no.	Type
	49 mm	Suitable for energy chains	-40 ... 70 °C	1 ... 25 m	550751	NEBM-M12G8-E-S1G9
				5 m	★ 550748	NEBM-M12G8-E-5-S1G9
				10 m	★ 550749	NEBM-M12G8-E-10-S1G9
				15 m	★ 550750	NEBM-M12G8-E-15-S1G9

1) Maximum 25 m. Available in 0.1 m increments.

**Encoder cable for motor controller CMMT-ST: straight plug**

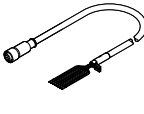
	Bending radius, moving cable	Cable characteristic	Ambient temperature	Cable length <sup>1)</sup>	Part no.	Type
	68 mm	Suitable for energy chains	-40 ... 80 °C	1 ... 25 m	1451591	NEBM-M12G8-E-LE8
				1.5 m	1451586	NEBM-M12G8-E-1.5-LE8
				2.5 m	★ 1451587	NEBM-M12G8-E-2.5-LE8
				5 m	★ 1451588	NEBM-M12G8-E-5-LE8
				7 m	★ 1451589	NEBM-M12G8-E-7-LE8
				10 m	★ 1451590	NEBM-M12G8-E-10-LE8

1) Maximum 25 m. Available in 0.1 m increments.

## Accessories

### Encoder cable for motor controller CMMT-ST: angled plug

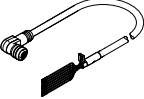
	Bending radius, moving cable	Cable characteristic	Ambient temperature	Cable length <sup>1)</sup>	Part no.	Type
	68 mm	Suitable for energy chains	-40 ... 80 °C	1 ... 25 m	1451679	NEBM-M12W8-E-LE8
				1.5 m	★ 1451674	NEBM-M12W8-E-1.5-LE8
				2.5 m	★ 1451675	NEBM-M12W8-E-2.5-LE8
				5 m	★ 1451676	NEBM-M12W8-E-5-LE8
				7 m	★ 1451677	NEBM-M12W8-E-7-LE8
				10 m	★ 1451678	NEBM-M12W8-E-10-LE8

1) Maximum 25 m. Available in 0.1 m increments.

Angled cables and leads can protrude into the area of the axis/drive.