



产品规格书

PRODUCT SPECIFICATION

客户名称 CUSTOMER: _____

产品型号 MODEL: HNB09A12

客户型号 USER'S MODEL: _____

日期 DATE: 2019-12-12

江苏华能电子有限公司			客户回签		
HUAWHA			CUSTOMER		
SERVE RATITY			CUSTOMER RATIGY		
拟制	审核	批准	检验	审核	批准
REPORT	CHECKED	APPROVED	TEST	CHECKED	APPROVED
唐华萍	工稿萍用章	张长华			

江苏华能电子有限公司

JIANGSU HUAWHA ELECTRONICS CO.,LTD

地址：江苏省泰州市兴化市陈堡镇工业园区

ADD:Chenbao Industrial Park, Chenbao Town, Xinghua,Taizhou City, Jiangsu China.

电话 [TEL:0523-83710666](tel:0523-83710666)

传真 [FAX:0523-83724866](tel:0523-83724866)

网址: www.huawha.com

邮箱: hndz_xf@huawha.com

1.基本规格/General specification

项目/Item		规格/Spec	条件/Condition
1	额定电压 Rated voltage	12VDC	
2	工作电压 Operation voltage	11~15VDC	
3	声压 Sound Pressure Level=SPL	Min 85dB	测试环境：标准状态，标准驱动电路， 额定电压 测试距离：0.1m Standard State,Standard Drive Circuit. Rated voltage,Distance at 0.1m
4	电流 current	Max30mA	
5	振荡频率 Oscillation frequency	2700±100Hz	
6	工作温度范围 Operating Temperature	-20~+70℃	
7	保存温度范围 Storage temperature	-40~+85℃	
8	外部尺寸 Externals size (mm)	Φ9*H5.5	参阅附图 Refer to the attached drawing
9	重量 Mass	0.7g	
10	材质 Housing Material	PBT	

2.电气和声学测试条件/Electrical And Acoustical Measuring Condition

<标准驱动电路>/<Standard Drive Circuit>

<标标测试治具>/<Standard Test Fixture>

Resonant frequency, 1/2 duty cycle. Square wave.

Signal amplitude should be large enough to saturate the transistor.

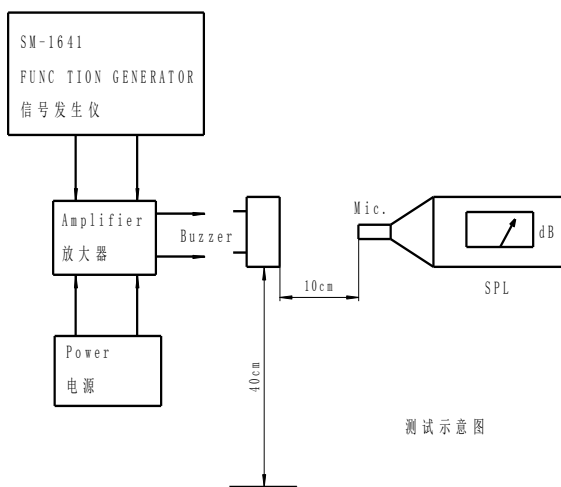
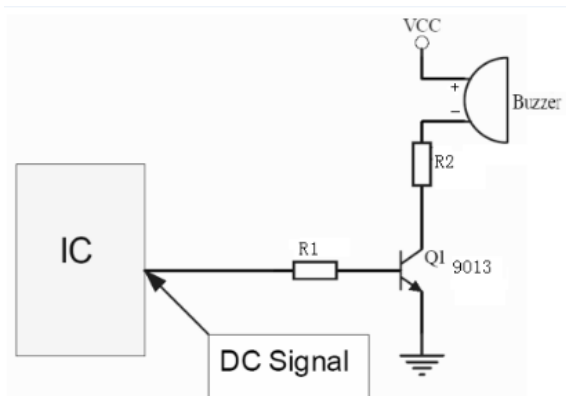

3. 可靠性测试/Reliability Test

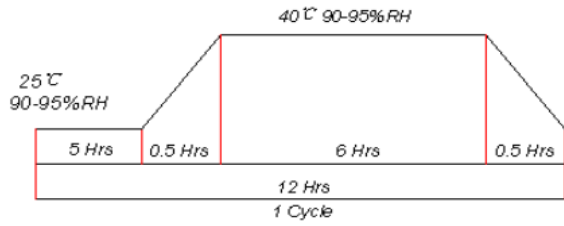
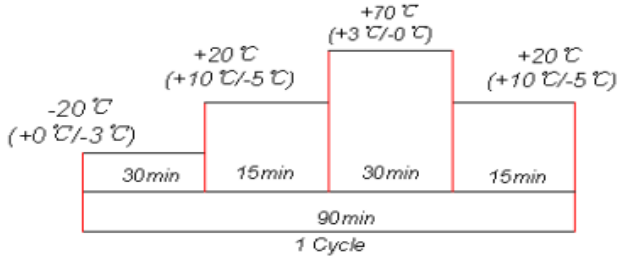
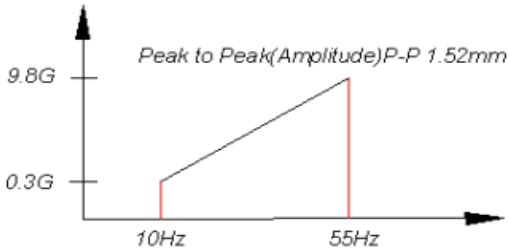
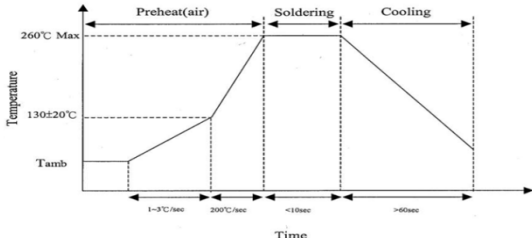
	项目 ITEM	测试方法 TEST
1	高温试验 High Temperature Test	在+80℃±2℃储存温度下存放 96 小时，恢复 2 小时后测试 After being placed in a chamber with +80±2℃ for 96 hours and then being placed in normal condition for 2 hours
2	低温试验 Low Temperature Test	在-20℃±2℃储存温度下存放 96 小时，恢复 2 小时后测试 After being placed in a chamber with -20±2℃ for 96 hours and then being placed in normal condition for 2 hours
3	恒定湿热试验 Humidity Test	 <p>The diagram shows a humidity test cycle. It starts at 25°C and 90-95% RH for 5 hours. Then, it ramps up to 40°C and 90-95% RH over 0.5 hours. It remains at 40°C and 90-95% RH for 6 hours. Finally, it ramps down to 25°C and 90-95% RH over 0.5 hours. The total duration of one cycle is 12 hours.</p>
4	温度变化试验 Temperature Cycle Test	 <p>The diagram shows a temperature cycle test. It starts at -20°C (+0°C/-3°C) for 30 minutes. Then, it ramps up to +20°C (+10°C/-5°C) over 15 minutes. It remains at +20°C for 30 minutes. Then, it ramps up to +70°C (+3°C/-0°C) over 15 minutes. It remains at +70°C for 30 minutes. Finally, it ramps down to +20°C (+10°C/-5°C) over 15 minutes. The total duration of one cycle is 90 minutes.</p>
5	振动试验 Vibration Test	 <p>The diagram shows a vibration test profile. The vertical axis is labeled 'Peak to Peak(Amplitude)P-P 1.52mm'. The horizontal axis is labeled 'Time'. The profile starts at 0.3G at 10Hz and ramps up to 9.8G at 55Hz. The total duration of the test is 1.52mm.</p>
6	跌落试验 Drop Test	70cm 高自由掉落到 40mm 的木板上，每个方向三次 Drop on a hard wood board of 40mm thick, any directions, three times, at the height of 70cm
7	插针的抗拉强度试验 Terminal Strength Pulling Test	插针承受 1.0kg 拉力，负荷时间 5s The force 5 seconds of 1.0kg is applied to each terminal.
8	可焊性试验 Solder ability Test	焊锡温度 255±5℃，浸润时间为 3±0.5s，试验后目测产品情况 Lead terminals are immersed in rosin for 5 seconds and then immersed in solder bath of 255±5℃ for 3±0.5 seconds.
9	波峰焊试验 Soldering Test	 <p>The diagram shows a soldering test profile. The vertical axis is labeled 'Temperature' and the horizontal axis is labeled 'Time'. The profile starts at Tamb, ramps up to 130±20°C at a rate of 1-3°C/sec. It then ramps up to 260°C Max at a rate of 200°C/sec. It remains at 260°C Max for <10sec. Finally, it ramps down at a rate of >60sec.</p>

4.尺寸图 Dimension

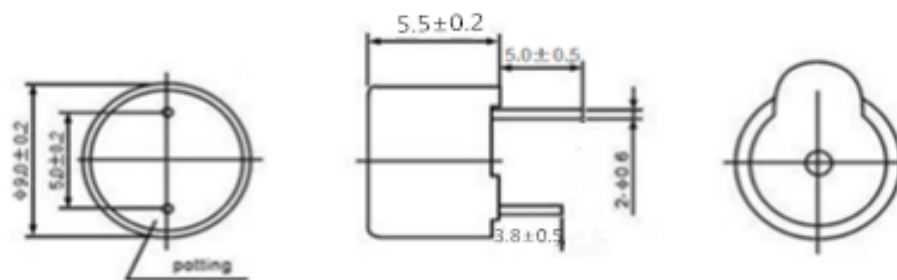

*Unit: mm; Tolerance: ± 0.3 mm Except Specified

*Housing Material: Black PBT

5.频率响应/Frequency Response

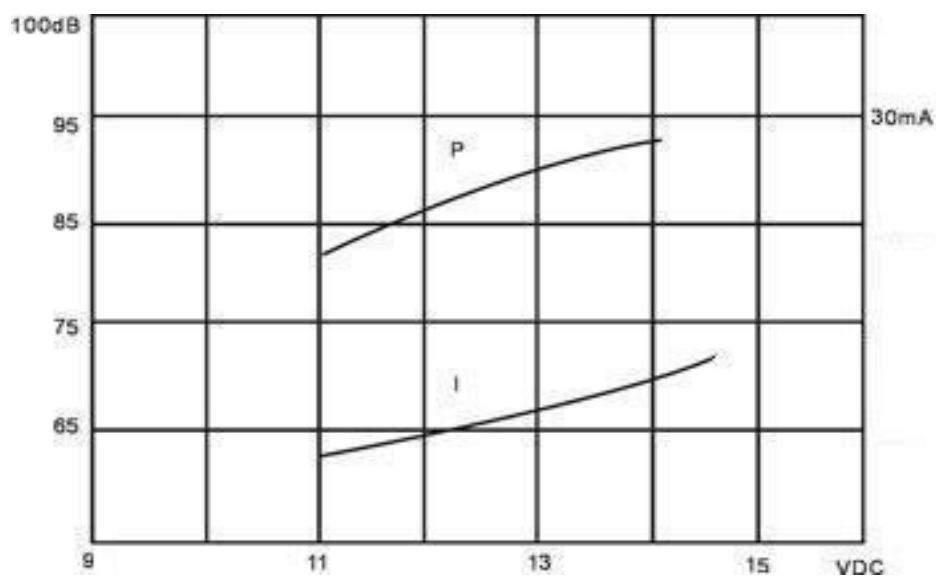

12Vo-p 50% duty Square wave, 10cm

5. 包装 picking

