

Three Level ANPC Q2Pack Module

NXH800A100L4Q2F2S1G/P1G, NXH800A100L4Q2F2S2G/P2G

This high-density, integrated power module combines high-performance IGBTs with rugged anti-parallel diodes.

Features

- Extremely Efficient Trench with Field Stop Technology
- Low Switching Loss Reduces System Power Dissipation
- Module Design Offers High Power Density
- Low Inductive Layout
- Low Package Height
- This is a Pb-Free Device

Typical Applications

- Solar Inverters
- Uninterruptable Power Supplies Systems

PACKAGE PICTURE

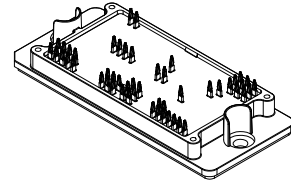

**Q2PACK POSITIVE PRESS FIT PINS
 CASE 180HG**

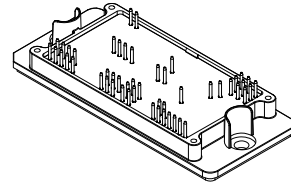

**Q2PACK POSITIVE SOLDER PINS
 CASE 180HH**

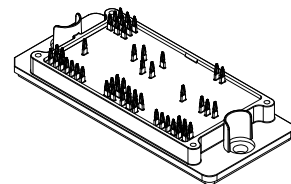

**Q2PACK NEGATIVE PRESS FIT PINS
 CASE 180CQ**

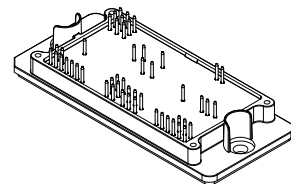

**Q2PACK NEGATIVE SOLDER PINS
 CASE 180BM**

MARKING DIAGRAMS

See detailed marking diagrams on page 2 of this data sheet.

PIN CONNECTIONS

See detailed pin connections on page 2 of this data sheet.

ORDERING INFORMATION

See detailed ordering and shipping information on page 8 of this data sheet.

NXH800A100L4Q2F2S1G/P1G, NXH800A100L4Q2F2S2G/P2G

SCHEMATICS

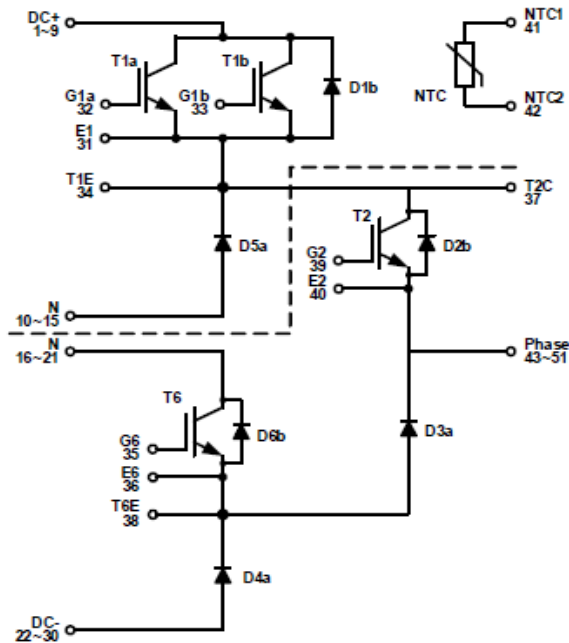

Figure 1. NXH800A100L4Q2F2X1G Schematic Diagram

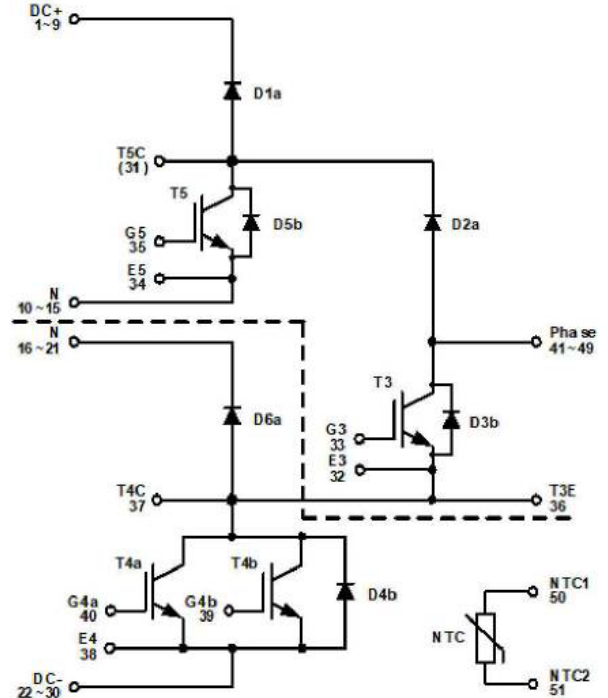
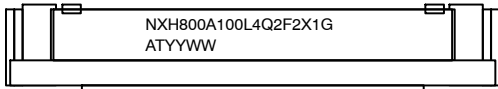

Figure 2. NXH800A100L4Q2F2X2G Schematic Diagram

MARKING DIAGRAMS



NXH800A100L4Q2F2 = Specific Device Code
 X = P or S
 G = Pb-Free Package
 AT = Assembly & Test Site Code
 YYWW = Year and Work Week Code

Figure 3. NXH800A100L4Q2F2X1G Marking Diagram

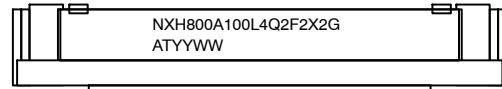

NXH800A100L4Q2F2 = Specific Device Code
 X = P or S
 G = Pb-Free Package
 AT = Assembly & Test Site Code
 YYWW = Year and Work Week Code

Figure 4. NXH800A100L4Q2F2X2G Marking Diagram

PIN CONNECTIONS

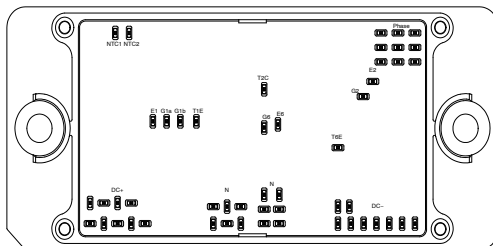

Figure 5. NXH800A100L4Q2F2X1G Pin Connection

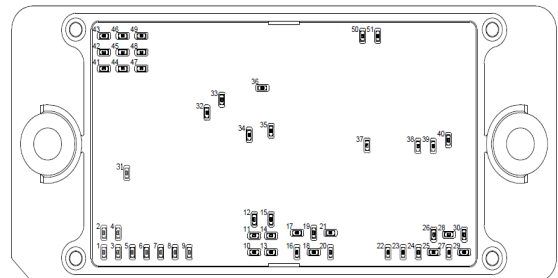

Figure 6. NXH800A100L4Q2F2X2G Pin Connection

NXH800A100L4Q2F2S1G/P1G, NXH800A100L4Q2F2S2G/P2G

Table 1. ABSOLUTE MAXIMUM RATINGS ($T_J = 25^\circ\text{C}$ unless otherwise noted)

Rating	Symbol	Value	Unit
OUTER IGBT (T1a, T1b, T4a, T4b)			
Collector-Emitter Voltage	V_{CES}	1000	V
Gate-Emitter Voltage Positive Transient Gate-Emitter Voltage ($T_{pulse} = 5 \mu\text{s}$, $D < 0.10$)	V_{GE}	± 20 30	V
Continuous Collector Current @ $T_C = 80^\circ\text{C}$	I_C	309	A
Pulsed Peak Collector Current @ $T_C = 80^\circ\text{C}$ ($T_J = 175^\circ\text{C}$)	$I_{C(Pulse)}$	927	A
Maximum Power Dissipation ($T_J = 175^\circ\text{C}$)	P_{tot}	714	W
Minimum Operating Junction Temperature	T_{JMIN}	-40	$^\circ\text{C}$
Maximum Operating Junction Temperature (Note 1)	T_{JMAX}	175	$^\circ\text{C}$
INNER IGBT (T2, T3)			
Collector-Emitter Voltage	V_{CES}	1000	V
Gate-Emitter Voltage Positive Transient Gate-Emitter Voltage ($T_{pulse} = 5 \mu\text{s}$, $D < 0.10$)	V_{GE}	± 20 30	V
Continuous Collector Current @ $T_C = 80^\circ\text{C}$	I_C	413	A
Pulsed Peak Collector Current @ $T_C = 80^\circ\text{C}$ ($T_J = 175^\circ\text{C}$)	$I_{C(Pulse)}$	1239	A
Maximum Power Dissipation ($T_J = 175^\circ\text{C}$)	P_{tot}	990	W
Minimum Operating Junction Temperature	T_{JMIN}	-40	$^\circ\text{C}$
Maximum Operating Junction Temperature (Note 1)	T_{JMAX}	175	$^\circ\text{C}$
NEUTRAL POINT IGBT (T5, T6)			
Collector-Emitter Voltage	V_{CES}	1000	V
Gate-Emitter Voltage Positive Transient Gate-Emitter Voltage ($T_{pulse} = 5 \mu\text{s}$, $D < 0.10$)	V_{GE}	± 20 30	V
Continuous Collector Current @ $T_C = 80^\circ\text{C}$	I_C	224	A
Pulsed Peak Collector Current @ $T_C = 80^\circ\text{C}$ ($T_J = 175^\circ\text{C}$)	$I_{C(Pulse)}$	672	A
Maximum Power Dissipation ($T_J = 175^\circ\text{C}$)	P_{tot}	543	W
Minimum Operating Junction Temperature	T_{JMIN}	-40	$^\circ\text{C}$
Maximum Operating Junction Temperature (Note 1)	T_{JMAX}	175	$^\circ\text{C}$
IGBT INVERSE DIODE (D1b, D2b, D3b, D4b, D5b, D6b)			
Peak Repetitive Reverse Voltage	V_{RRM}	1000	V
Continuous Forward Current @ $T_C = 80^\circ\text{C}$	I_F	61	A
Repetitive Peak Forward Current ($T_J = 175^\circ\text{C}$)	I_{FRM}	183	A
Maximum Power Dissipation ($T_J = 175^\circ\text{C}$)	P_{tot}	151	W
Minimum Operating Junction Temperature	T_{JMIN}	-40	$^\circ\text{C}$
Maximum Operating Junction Temperature	T_{JMAX}	175	$^\circ\text{C}$
DIODES (D1a, D2a, D3a, D4a)			
Peak Repetitive Reverse Voltage	V_{RRM}	1000	V
Continuous Forward Current @ $T_C = 80^\circ\text{C}$	I_F	177	A
Repetitive Peak Forward Current ($T_J = 175^\circ\text{C}$)	I_{FRM}	531	A
Maximum Power Dissipation ($T_J = 175^\circ\text{C}$)	P_{tot}	446	W
Minimum Operating Junction Temperature	T_{JMIN}	-40	$^\circ\text{C}$
Maximum Operating Junction Temperature	T_{JMAX}	175	$^\circ\text{C}$

NXH800A100L4Q2F2S1G/P1G, NXH800A100L4Q2F2S2G/P2G

Table 1. ABSOLUTE MAXIMUM RATINGS ($T_J = 25^\circ\text{C}$ unless otherwise noted) (continued)

Rating	Symbol	Value	Unit
NEUTRAL POINT DIODES (D5a, D6a)			
Peak Repetitive Reverse Voltage	V_{RRM}	1000	V
Continuous Forward Current @ $T_C = 80^\circ\text{C}$	I_F	238	A
Repetitive Peak Forward Current ($T_J = 175^\circ\text{C}$)	I_{FRM}	714	A
Maximum Power Dissipation ($T_J = 175^\circ\text{C}$)	P_{tot}	565	W
Minimum Operating Junction Temperature	T_{JMIN}	-40	$^\circ\text{C}$
Maximum Operating Junction Temperature	T_{JMAX}	175	$^\circ\text{C}$

Table 2. THERMAL AND INSULATION PROPERTIES ($T_J = 25^\circ\text{C}$ unless otherwise noted)

Rating	Symbol	Value	Unit
THERMAL PROPERTIES			
Operating Temperature under Switching Condition	T_{VJOP}	-40 to +150	$^\circ\text{C}$
Storage Temperature Range	T_{stg}	-40 to +125	$^\circ\text{C}$
INSULATION PROPERTIES			
Isolation Test Voltage, $t = 1$ s, 50 Hz	V_{is}	4000	V_{RMS}
Creepage Distance		12.7	mm
Comparative Tracking Index	CTI	> 600	

Stresses exceeding those listed in the Maximum Ratings table may damage the device. If any of these limits are exceeded, device functionality should not be assumed, damage may occur and reliability may be affected.

1. Refer to ELECTRICAL CHARACTERISTICS, RECOMMENDED OPERATING RANGES and/or APPLICATION INFORMATION for Safe Operating parameters.

NXH800A100L4Q2F2S1G/P1G, NXH800A100L4Q2F2S2G/P2G

ELECTRICAL CHARACTERISTICS (T_J = 25°C unless otherwise specified)

Characteristic	Test Conditions	Symbol	Min	Typ	Max	Unit
----------------	-----------------	--------	-----	-----	-----	------

IGBT (T1a, T1b, T4a, T4b) CHARACTERISTICS

Collector-Emitter Cutoff Current	V _{GE} = 0 V, V _{CE} = 1000 V	I _{CES}	–	–	20	μA
Collector-Emitter Saturation Voltage	V _{GE} = 15 V, I _C = 400 A, T _J = 25°C	V _{CE(sat)}	–	1.69	2.3	V
	V _{GE} = 15 V, I _C = 400 A, T _J = 175°C		–	1.95	–	
Gate-Emitter Threshold Voltage	V _{GE} = V _{CE} , I _C = 400 mA	V _{GE(TH)}	3.4	4.92	6.7	V
Gate Leakage Current	V _{GE} = ±20 V, V _{CE} = 0 V	I _{GES}	–	–	±2	μA
Turn-on Delay Time	T _J = 25°C V _{CE} = 600 V, I _C = 200 A V _{GE} = -9 V, 15 V R _{Goff} = 23 Ω, R _{Gon} = 15 Ω (T1a, T1b tested together)	t _{d(on)}	–	189.93	–	ns
Rise Time		t _r	–	52.06	–	
Turn-off Delay Time		t _{d(off)}	–	970.3	–	
Fall Time		t _f	–	22.56	–	
Turn-on Switching Loss per Pulse		E _{on}	–	7.71	–	mJ
Turn-off Switching Loss per Pulse		E _{off}	–	8.12	–	
Turn-on Delay Time		T _J = 125°C V _{CE} = 600 V, I _C = 200 A V _{GE} = -9 V, 15 V R _{Goff} = 23 Ω, R _{Gon} = 15 Ω (T1a, T1b tested together)	t _{d(on)}	–	164.22	–
Rise Time	t _r		–	59.58	–	
Turn-off Delay Time	t _{d(off)}		–	1088.34	–	
Fall Time	t _f		–	33.6	–	
Turn-on Switching Loss per Pulse	E _{on}		–	11.57	–	mJ
Turn-off Switching Loss per Pulse	E _{off}		–	10.77	–	
Input Capacitance	V _{CE} = 20 V, V _{GE} = 0 V, f = 100 kHz (T1a, T1b tested together)		C _{ies}	–	49700	–
Output Capacitance		C _{oes}	–	1530	–	
Reverse Transfer Capacitance		C _{res}	–	308	–	
Total Gate Charge	V _{CE} = 600 V, I _C = 300 A, V _{GE} = -15 V~15 V (T1a, T1b tested together)	Q _g	–	3040	–	nC
Thermal Resistance – Chip-to-Heatsink	Thermal grease, Thickness = 2.1 Mil ±2% λ = 2.9 W/mK	R _{thJH}	–	0.225	–	K/W
Thermal Resistance – Chip-to-Case		R _{thJC}	–	0.133	–	K/W

IGBT INVERSE DIODE (D1b, D2b, D3b, D4b, D5b, D6b) CHARACTERISTICS

Diode Forward Voltage	I _F = 100 A, T _J = 25°C	V _F	–	2.73	3.7	V
	I _F = 100 A, T _J = 175°C		–	2.39	–	
Thermal Resistance – Chip-to-Heatsink	Thermal grease, Thickness = 2.1 Mil ±2% λ = 2.9 W/mK	R _{thJH}	–	0.770	–	K/W
Thermal Resistance – Chip-to-Case		R _{thJC}	–	0.63	–	K/W

NXH800A100L4Q2F2S1G/P1G, NXH800A100L4Q2F2S2G/P2G

ELECTRICAL CHARACTERISTICS (T_J = 25°C unless otherwise specified) (continued)

Characteristic	Test Conditions	Symbol	Min	Typ	Max	Unit	
IGBT (T₂, T₃) CHARACTERISTICS							
Collector-Emitter Cutoff Current	V _{GE} = 0 V, V _{CE} = 1000 V	I _{CES}	–	–	20	μA	
Collector-Emitter Saturation Voltage	V _{GE} = 15 V, I _C = 600 A, T _J = 25°C	V _{CE(sat)}	–	1.75	2.3	V	
	V _{GE} = 15 V, I _C = 600 A, T _J = 175°C		–	2.15	–		
Gate-Emitter Threshold Voltage	V _{GE} = V _{CE} , I _C = 600 mA	V _{GE(TH)}	3.4	4.83	6.7	V	
Gate Leakage Current	V _{GE} = ±20 V, V _{CE} = 0 V	I _{GES}	–	–	±2	μA	
Turn-on Delay Time	T _J = 25°C V _{CE} = 600 V, I _C = 200 A V _{GE} = -9 V, 15 V R _{Gon} = 11 Ω, R _{Goff} = 23 Ω	t _{d(on)}	–	233.73	–	ns	
Rise Time		t _r	–	68	–		
Turn-off Delay Time		t _{d(off)}	–	1364.18	–		
Fall Time		t _f	–	79.12	–		
Turn-on Switching Loss per Pulse		E _{on}	–	7.83	–		mJ
Turn-off Switching Loss per Pulse		E _{off}	–	16.73	–		
Turn-on Delay Time	T _J = 125°C V _{CE} = 600 V, I _C = 200 A V _{GE} = -9 V, 15 V R _{Gon} = 11 Ω, R _{Goff} = 23 Ω	t _{d(on)}	–	213.78	–	ns	
Rise Time		t _r	–	75.99	–		
Turn-off Delay Time		t _{d(off)}	–	1514.94	–		
Fall Time		t _f	–	47.53	–		
Turn-on Switching Loss per Pulse		E _{on}	–	10.87	–		mJ
Turn-off Switching Loss per Pulse		E _{off}	–	17.39	–		
Input Capacitance	V _{CE} = 20 V, V _{GE} = 0 V, f = 100 kHz	C _{ies}	–	38100	–	pF	
Output Capacitance		C _{oes}	–	1230	–		
Reverse Transfer Capacitance		C _{res}	–	226	–		
Total Gate Charge	V _{CE} = 600 V, I _C = 300 A, V _{GE} = 15 V	Q _g	–	2230	–	nC	
Thermal Resistance – Chip-to-Heatsink	Thermal grease, Thickness = 2.1 Mil ±2% λ = 2.9 W/mK	R _{thJH}	–	0.168	–	K/W	
Thermal Resistance – Chip-to-Case		R _{thJC}	–	0.096	–	K/W	

DIODES (D1a, D2a, D3a, D4a) CHARACTERISTICS

Diode Forward Voltage	I _F = 300 A, T _J = 25°C	V _F	–	2.76	3.7	V
	I _F = 300 A, T _J = 175°C		–	2.43	–	
Reverse Recovery Time	T _J = 25°C V _{CE} = 600 V, I _C = 200 A V _{GE} = -9 V, 15 V, R _G = 11 Ω	t _{rr}	–	105.26	–	ns
Reverse Recovery Charge		Q _{rr}	–	4.344	–	μC
Peak Reverse Recovery Current		I _{RRM}	–	106.04	–	A
Peak Rate of Fall of Recovery Current		di/dt	–	3.242	–	A/ns
Reverse Recovery Energy		E _{rr}	–	1.304	–	mJ
Reverse Recovery Time		T _J = 125°C V _{CE} = 600 V, I _C = 200 A V _{GE} = -9 V, 15 V, R _G = 11 Ω	t _{rr}	–	176.9	–
Reverse Recovery Charge	Q _{rr}		–	12.771	–	μC
Peak Reverse Recovery Current	I _{RRM}		–	154.24	–	A
Peak Rate of Fall of Recovery Current	di/dt		–	2.795	–	A/ns
Reverse Recovery Energy	E _{rr}		–	4.318	–	mJ
Thermal Resistance – Chip-to-Heatsink	Thermal grease, Thickness = 2.1 Mil ±2% λ = 2.9 W/mK		R _{thJH}	–	0.315	–
Thermal Resistance – Chip-to-Case		R _{thJC}	–	0.213	–	K/W

NXH800A100L4Q2F2S1G/P1G, NXH800A100L4Q2F2S2G/P2G

ELECTRICAL CHARACTERISTICS (T_J = 25°C unless otherwise specified) (continued)

Characteristic	Test Conditions	Symbol	Min	Typ	Max	Unit	
IGBT (T5, T6) CHARACTERISTICS							
Collector-Emitter Cutoff Current	V _{GE} = 0 V, V _{CE} = 1000 V	I _{CES}	–	–	20	μA	
Collector-Emitter Saturation Voltage	V _{GE} = 15 V, I _C = 300 A, T _J = 25°C	V _{CE(sat)}	–	1.70	2.3	V	
	V _{GE} = 15 V, I _C = 300 A, T _J = 175°C		–	2.05	–		
Gate-Emitter Threshold Voltage	V _{GE} = V _{CE} , I _C = 300 mA	V _{GE(TH)}	4.1	5.03	6.0	V	
Gate Leakage Current	V _{GE} = ±20 V, V _{CE} = 0 V	I _{GES}	–	–	±2	μA	
Turn-on Delay Time	T _J = 25°C V _{CE} = 600 V, I _C = 200 A V _{GE} = -9 V, 15 V, R _{Gon} = 11 Ω, R _{Goff} = 23 Ω	t _{d(on)}	–	120.19	–	ns	
Rise Time		t _r	–	50.18	–		
Turn-off Delay Time		t _{d(off)}	–	682.65	–		
Fall Time		t _f	–	39.56	–		
Turn-on Switching Loss per Pulse		E _{on}	–	8.58	–		mJ
Turn-off Switching Loss per Pulse		E _{off}	–	7.82	–		
Turn-on Delay Time		T _J = 125°C V _{CE} = 600 V, I _C = 200 A V _{GE} = -9 V, 15 V, R _{Gon} = 11 Ω, R _{Goff} = 23 Ω	t _{d(on)}	–	112.48		–
Rise Time	t _r		–	57.46	–		
Turn-off Delay Time	t _{d(off)}		–	747.87	–		
Fall Time	t _f		–	23.765	–		
Turn-on Switching Loss per Pulse	E _{on}		–	13.77	–	mJ	
Turn-off Switching Loss per Pulse	E _{off}		–	10.41	–		
Input Capacitance	V _{CE} = 20 V, V _{GE} = 0 V, f = 100 kHz		C _{ies}	–	17400	–	pF
Output Capacitance		C _{oes}	–	654	–		
Reverse Transfer Capacitance		C _{res}	–	101	–		
Total Gate Charge	V _{CE} = 600 V, I _C = 300 A, V _{GE} = 15 V	Q _g	–	1004	–	nC	
Thermal Resistance – Chip-to-Heatsink	Thermal grease, Thickness = 2.1 Mil ±2% λ = 2.9 W/mK	R _{thJH}	–	0.264	–	K/W	
Thermal Resistance – Chip-to-Case		R _{thJC}	–	0.175	–	K/W	

DIODES (D5a, D6a) CHARACTERISTICS

Diode Forward Voltage	I _F = 400 A, T _J = 25°C	V _F	–	2.83	3.7	V
	I _F = 400 A, T _J = 175°C		–	2.42	–	
Reverse Recovery Time	T _J = 25°C V _{CE} = 600 V, I _C = 200 A V _{GE} = -9 V, 15 V, R _G = 15 Ω	t _{rr}	–	92.74	–	ns
Reverse Recovery Charge		Q _{rr}	–	5.66	–	μC
Peak Reverse Recovery Current		I _{RRM}	–	136.18	–	A
Peak Rate of Fall of Recovery Current		di/dt	–	3.14	–	A/ns
Reverse Recovery Energy		E _{rr}	–	2.03	–	mJ
Reverse Recovery Time		T _J = 125°C V _{CE} = 600 V, I _C = 200 A V _{GE} = -9 V, 15 V, R _G = 15 Ω	t _{rr}	–	159.63	–
Reverse Recovery Charge	Q _{rr}		–	17.00	–	μC
Peak Reverse Recovery Current	I _{RRM}		–	223.97	–	A
Peak Rate of Fall of Recovery Current	di/dt		–	2.71	–	A/ns
Reverse Recovery Energy	E _{rr}		–	6.80	–	mJ
Thermal Resistance – Chip-to-Heatsink	Thermal grease, Thickness = 2.1 Mil ±2% λ = 2.9 W/mK		R _{thJH}	–	0.244	–
Thermal Resistance – Chip-to-Case		R _{thJC}	–	0.168	–	K/W

NXH800A100L4Q2F2S1G/P1G, NXH800A100L4Q2F2S2G/P2G

ELECTRICAL CHARACTERISTICS (T_J = 25°C unless otherwise specified) (continued)

Characteristic	Test Conditions	Symbol	Min	Typ	Max	Unit
THERMISTOR CHARACTERISTICS						
Nominal Resistance	T = 25°C	R ₂₅	–	22	–	kΩ
Nominal Resistance	T = 100°C	R ₁₀₀	–	1504	–	Ω
Deviation of R25		ΔR/R	–1	–	1	%
Power Dissipation		P _D	–	187.5	–	mW
Power Dissipation Constant			–	1.5	–	mW/K
B-value	B(25/100), tolerance ±3%		–	3980	–	K

Product parametric performance is indicated in the Electrical Characteristics for the listed test conditions, unless otherwise noted. Product performance may not be indicated by the Electrical Characteristics if operated under different conditions.

ORDERING INFORMATION

Part Number	Marking	Package	Shipping
NXH800A100L4Q2F2S1G	NXH800A100L4Q2F2S1G	Q2PACK – Case 180HH (Pb-Free/Halide-Free)	12 Units / Blister Tray
NXH800A100L4Q2F2P1G	NXH800A100L4Q2F2P1G	Q2PACK – Case 180HG (Pb-Free/Halide-Free)	12 Units / Blister Tray
NXH800A100L4Q2F2S2G	NXH800A100L4Q2F2S2G	Q2PACK – Case 180BM (Pb-Free/Halide-Free)	12 Units / Blister Tray
NXH800A100L4Q2F2P2G	NXH800A100L4Q2F2P2G	Q2PACK – Case 180CQ (Pb-Free/Halide-Free)	12 Units / Blister Tray

NXH800A100L4Q2F2S1G/P1G, NXH800A100L4Q2F2S2G/P2G

TYPICAL CHARACTERISTICS – IGBT T1/T4 AND D5A/D6A DIODE

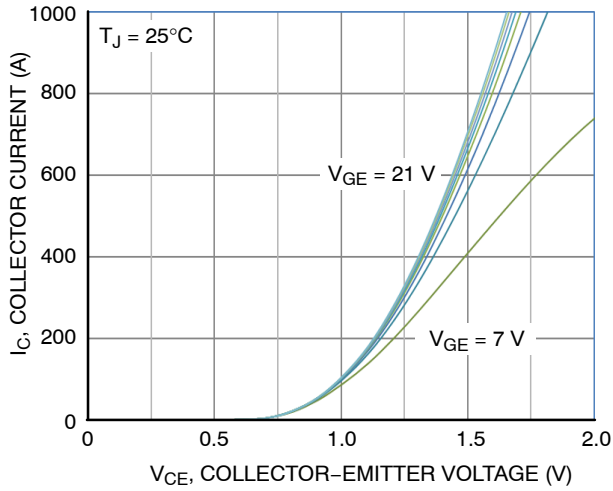

Figure 7. Typical Output Characteristics

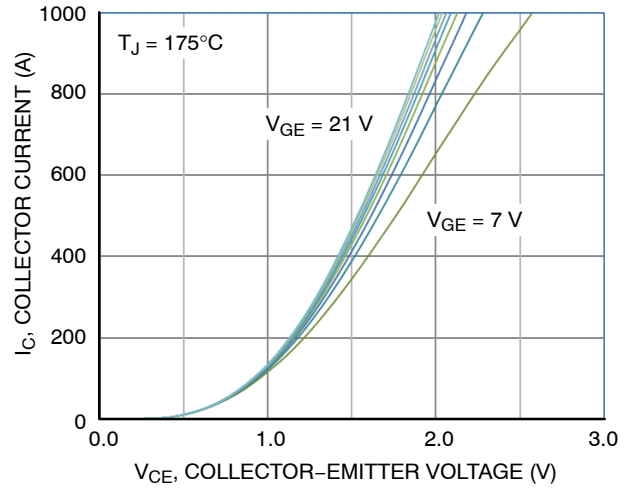

Figure 8. Typical Output Characteristics

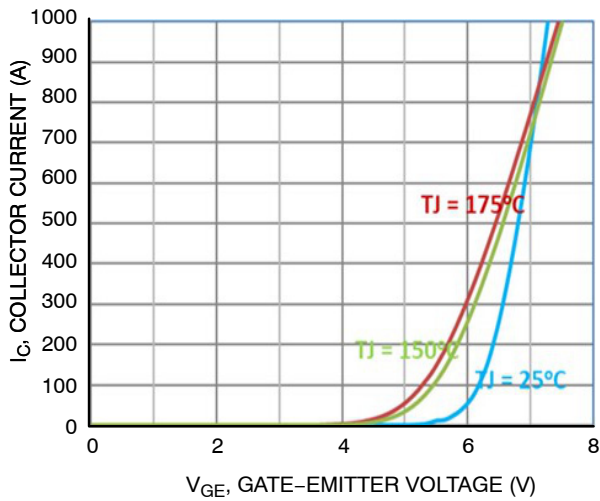

Figure 9. Transfer Characteristics

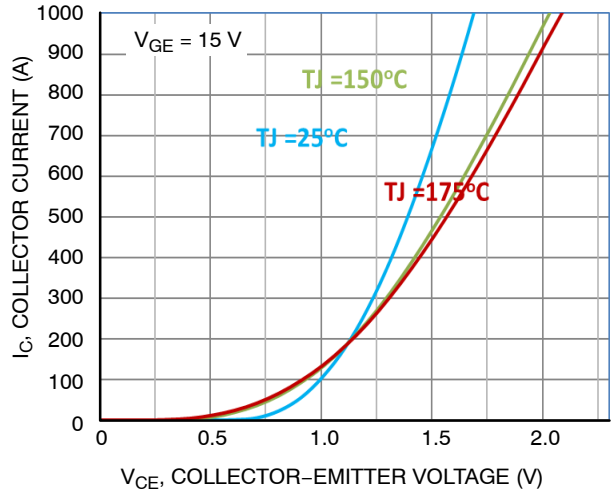

Figure 10. Saturation Voltage Characteristics

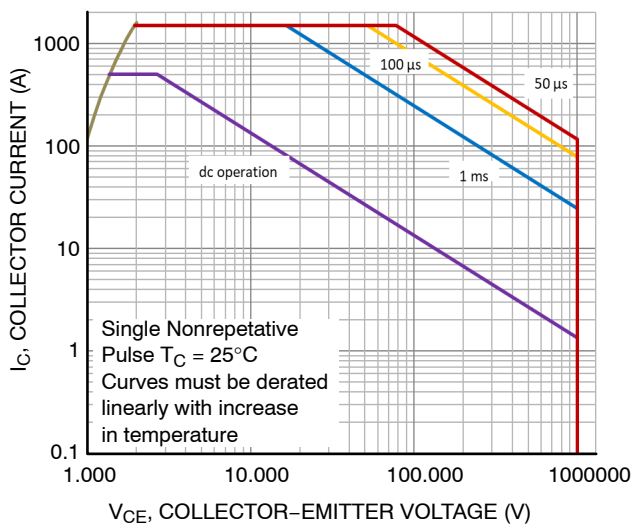

Figure 11. FBSOA

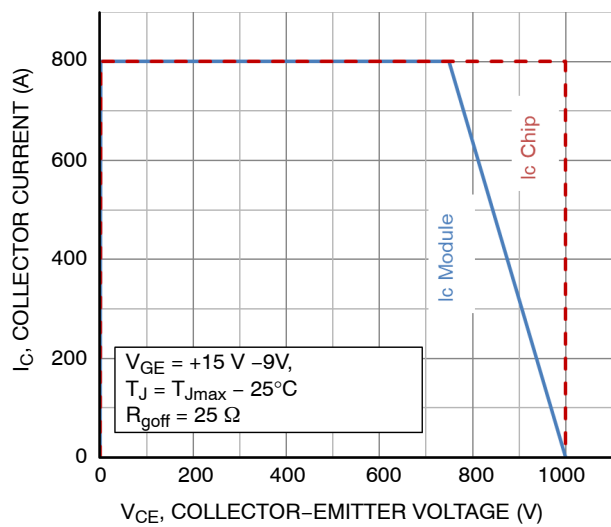

Figure 12. RBSOA

NXH800A100L4Q2F2S1G/P1G, NXH800A100L4Q2F2S2G/P2G

TYPICAL CHARACTERISTICS – IGBT T1/T4 AND D5A/D6A DIODE (CONTINUED)

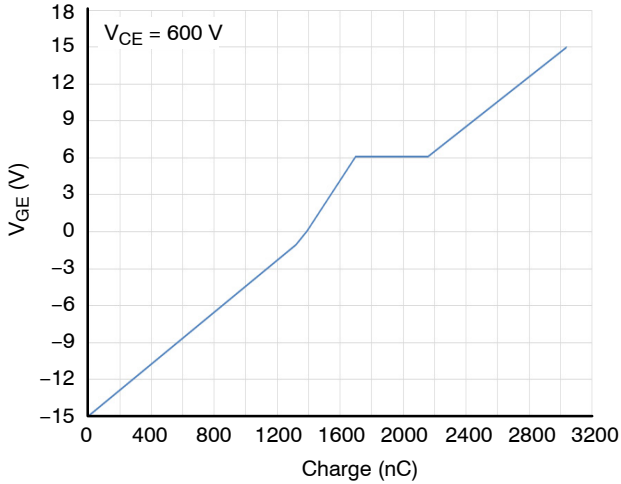

Figure 13. Gate Voltage vs. Gate Charge (T1a + T1b)

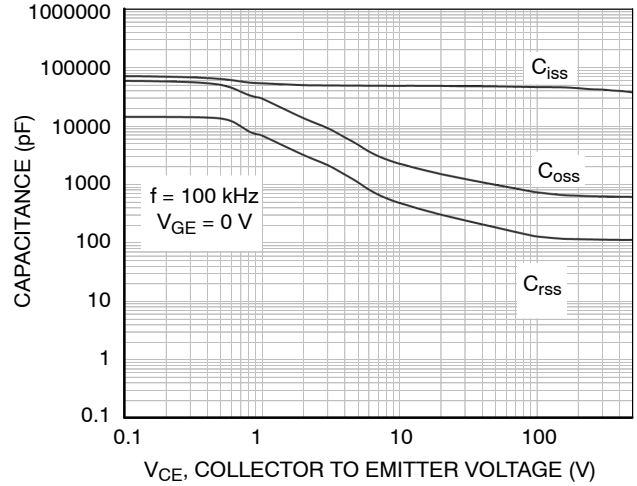

Figure 14. Capacitance (T1, T4)

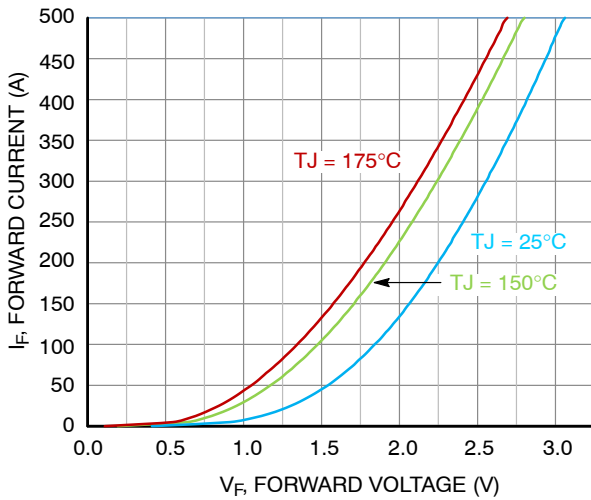

Figure 15. Diode Forward Characteristics

TYPICAL CHARACTERISTICS – IGBT T2/T3 AND D1A/D4A, D2A/D3A DIODE

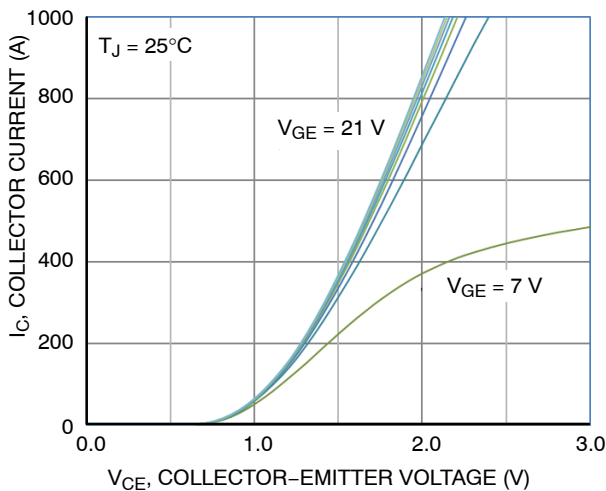

Figure 16. Typical Output Characteristics

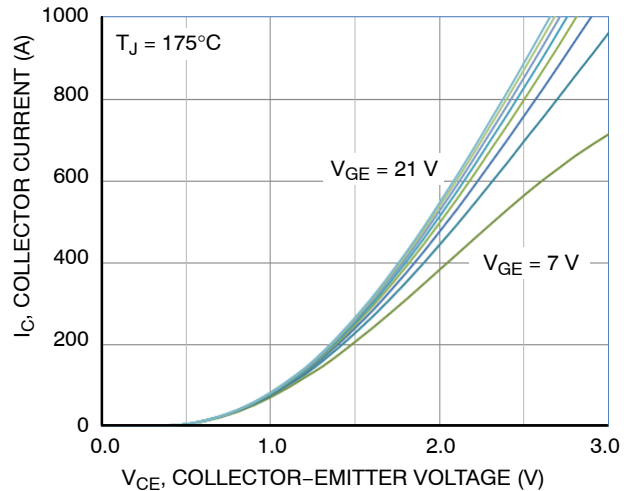

Figure 17. Typical Output Characteristics

NXH800A100L4Q2F2S1G/P1G, NXH800A100L4Q2F2S2G/P2G

TYPICAL CHARACTERISTICS – IGBT T2/T3 AND D1A/D4A, D2A/D3A DIODE (CONTINUED)

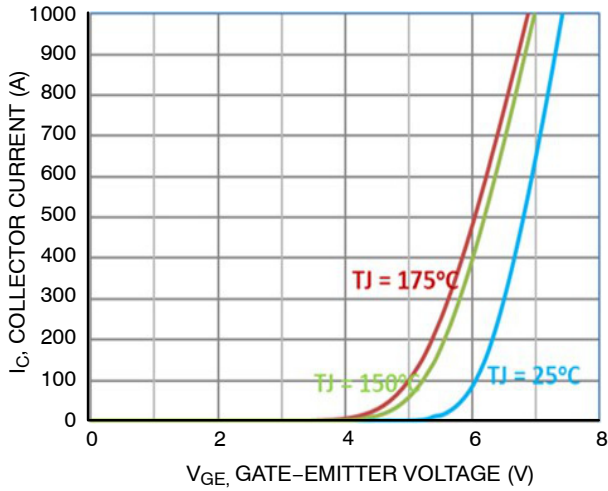

Figure 18. Transfer Characteristics

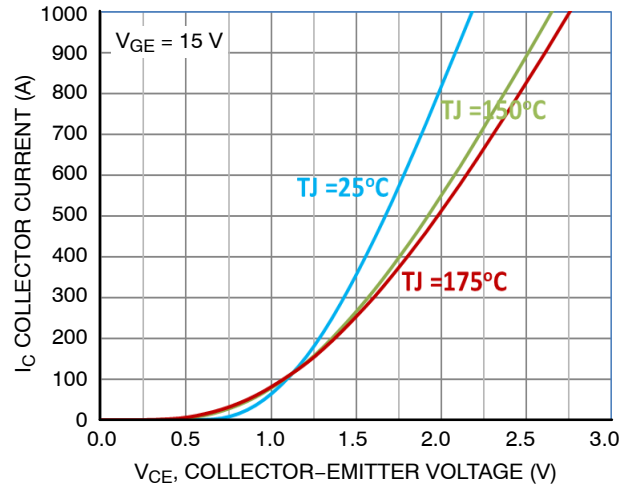

Figure 19. Saturation Voltage Characteristic

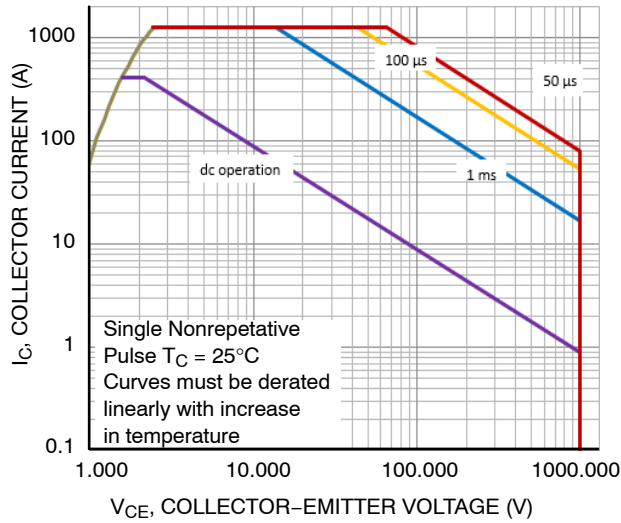

Figure 20. FBSOA

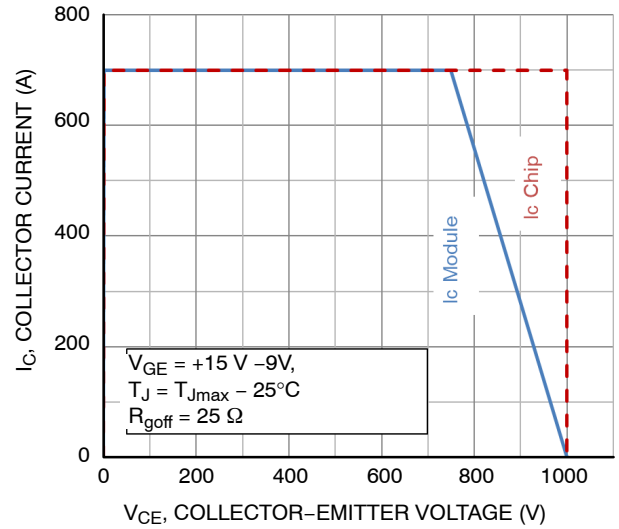

Figure 21. RBSOA

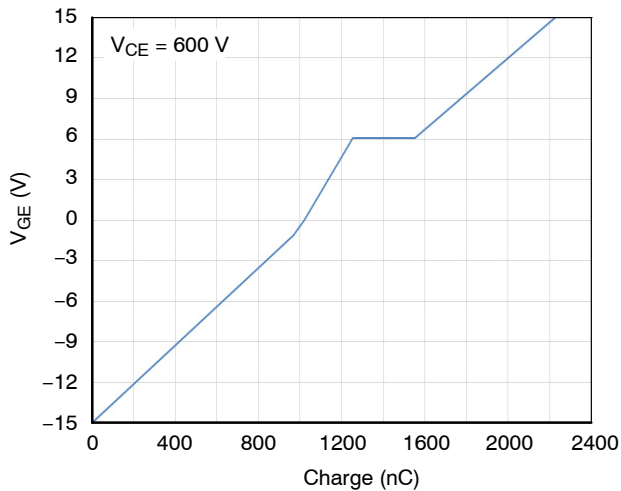

Figure 22. Gate Voltage vs. Gate Charge

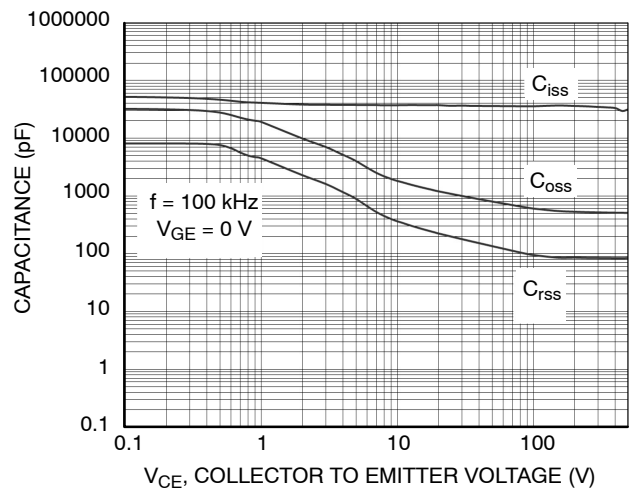

Figure 23. Capacitance

NXH800A100L4Q2F2S1G/P1G, NXH800A100L4Q2F2S2G/P2G

TYPICAL CHARACTERISTICS – IGBT T2/T3 AND D1A/D4A, D2A/D3A DIODE (CONTINUED)

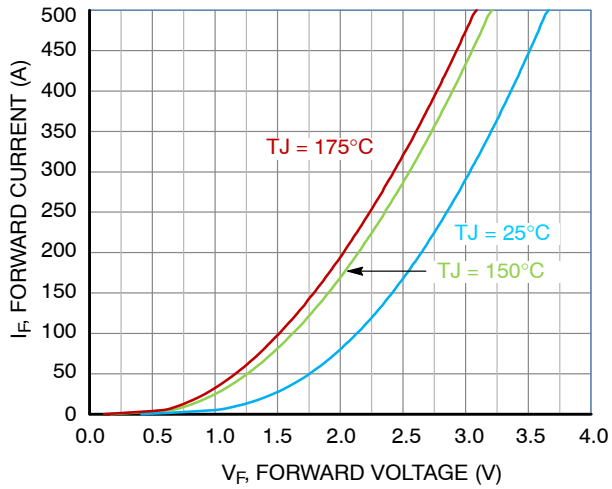

Figure 24. Diode Forward Characteristics

TYPICAL CHARACTERISTICS – IGBT T5/T6 AND D1B/D2B/D6B, D3B/D4B/D5B DIODE (CONTINUED)

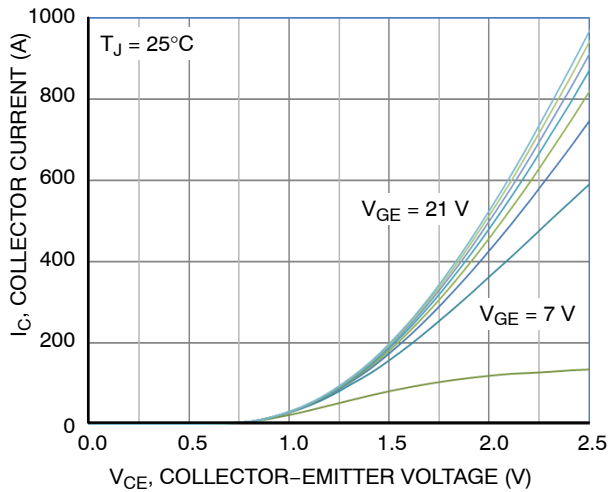

Figure 25. Typical Output Characteristics

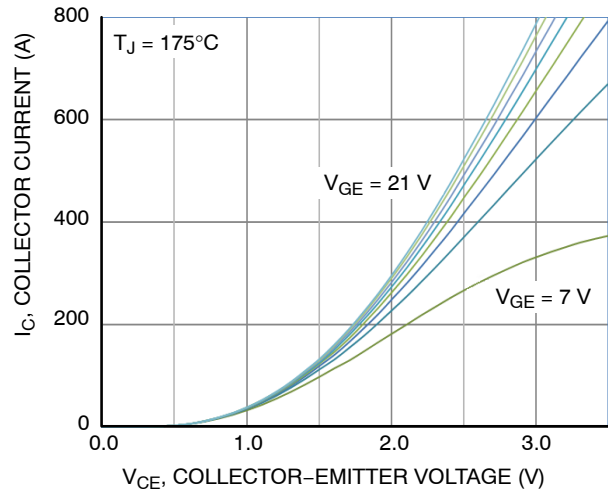

Figure 26. Typical Output Characteristics

NXH800A100L4Q2F2S1G/P1G, NXH800A100L4Q2F2S2G/P2G

TYPICAL CHARACTERISTICS – IGBT T5/T6 AND D1B/D2B/D6B, D3B/D4B/D5B DIODE (CONTINUED)

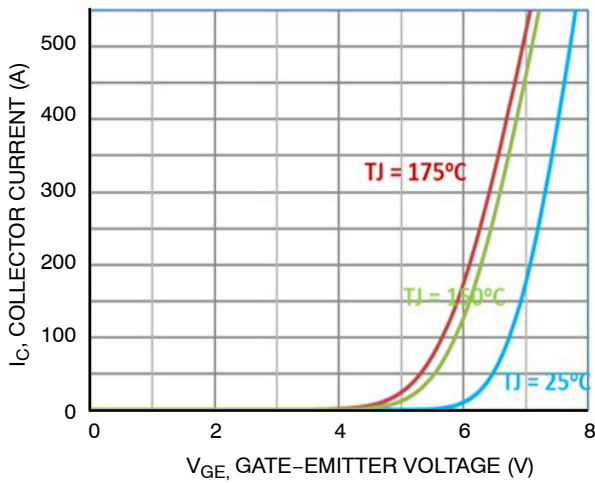

Figure 27. Transfer Characteristics

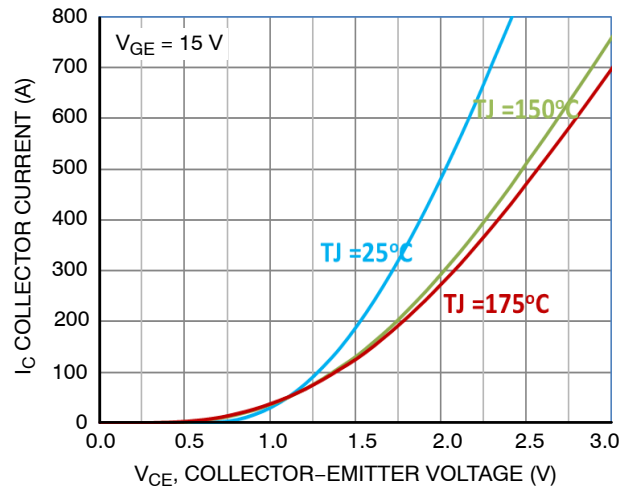

Figure 28. Saturation Voltage Characteristic

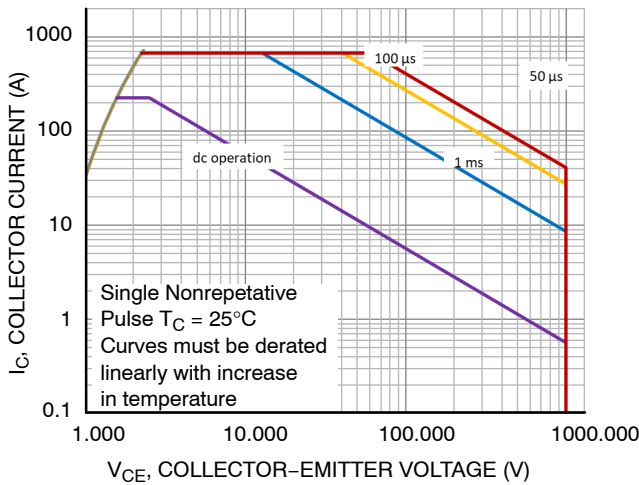

Figure 29. FBSOA

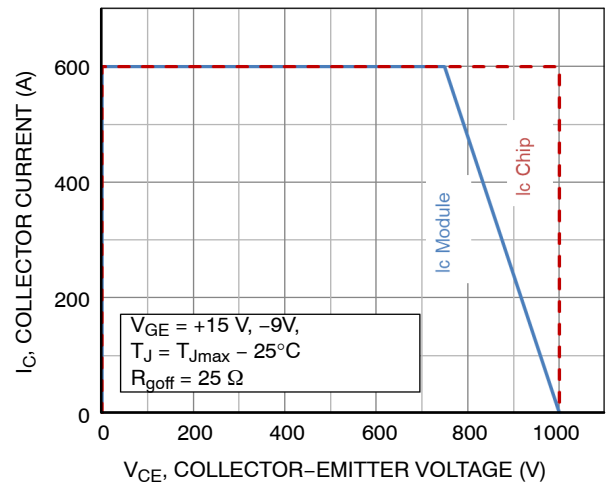

Figure 30. RBSOA

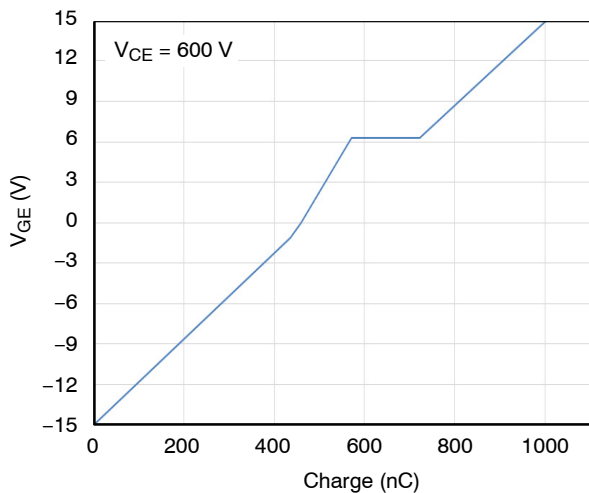

Figure 31. Gate Voltage vs. Gate Charge

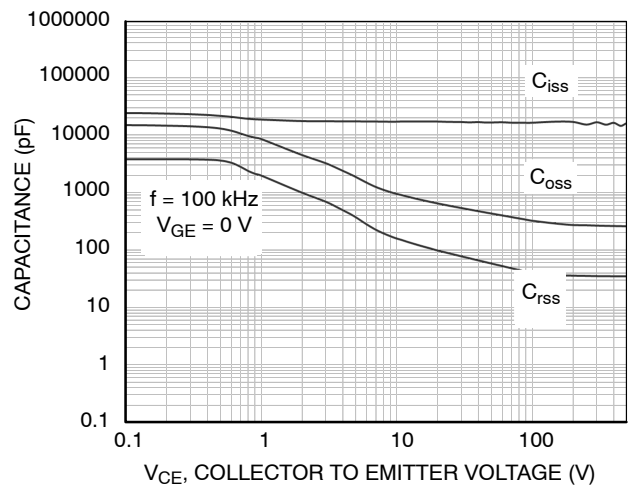

Figure 32. Capacitance

NXH800A100L4Q2F2S1G/P1G, NXH800A100L4Q2F2S2G/P2G

TYPICAL CHARACTERISTICS – IGBT T5/T6 AND D1B/D2B/D6B, D3B/D4B/D5B DIODE (CONTINUED)

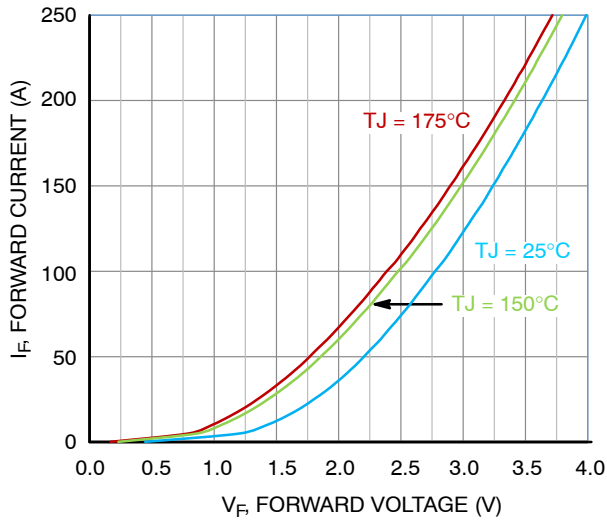

Figure 33. Diode Forward Characteristics

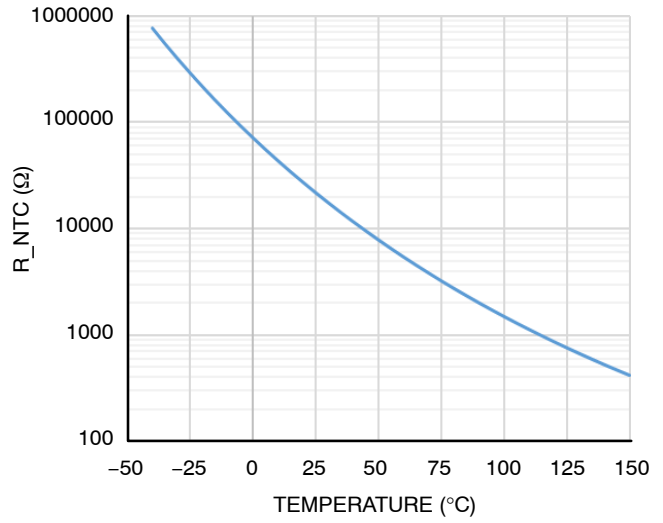

Figure 34. Temperature vs. NTC Value

TYPICAL CHARACTERISTICS – IGBT AND DIODE

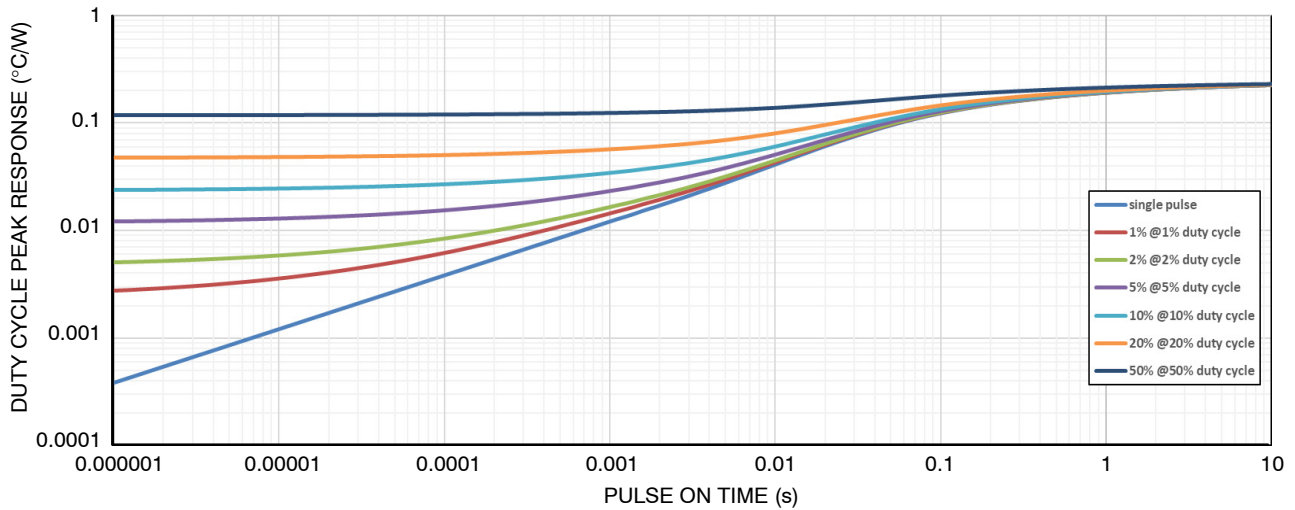

Figure 35. Transient Thermal Impedance (T1a, T1b, T4a, T4b)

NXH800A100L4Q2F2S1G/P1G, NXH800A100L4Q2F2S2G/P2G

TYPICAL CHARACTERISTICS – IGBT AND DIODE (CONTINUED)

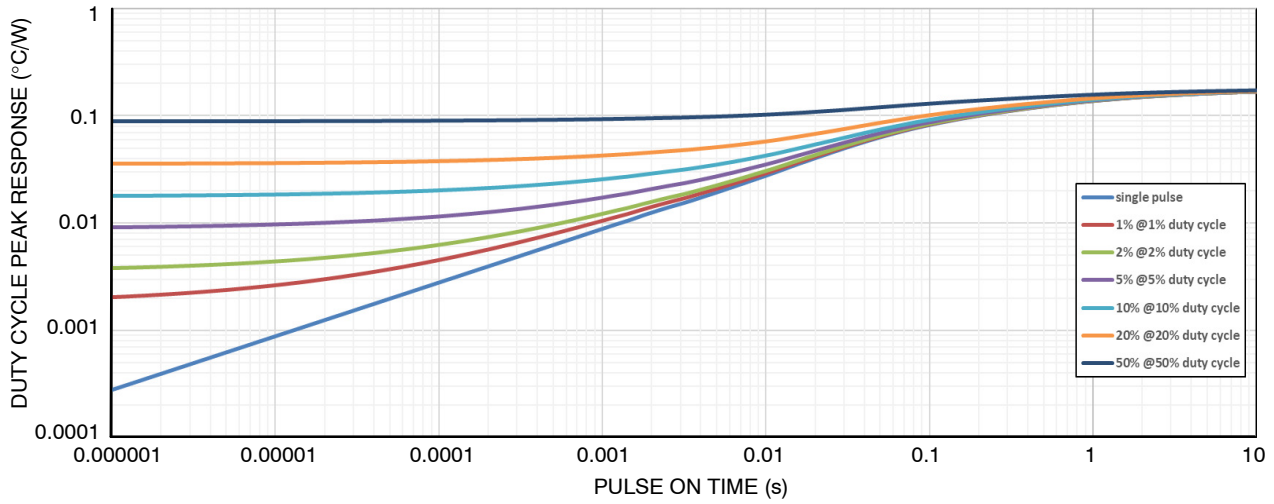

Figure 36. Transient Thermal Impedance (T2, T3)

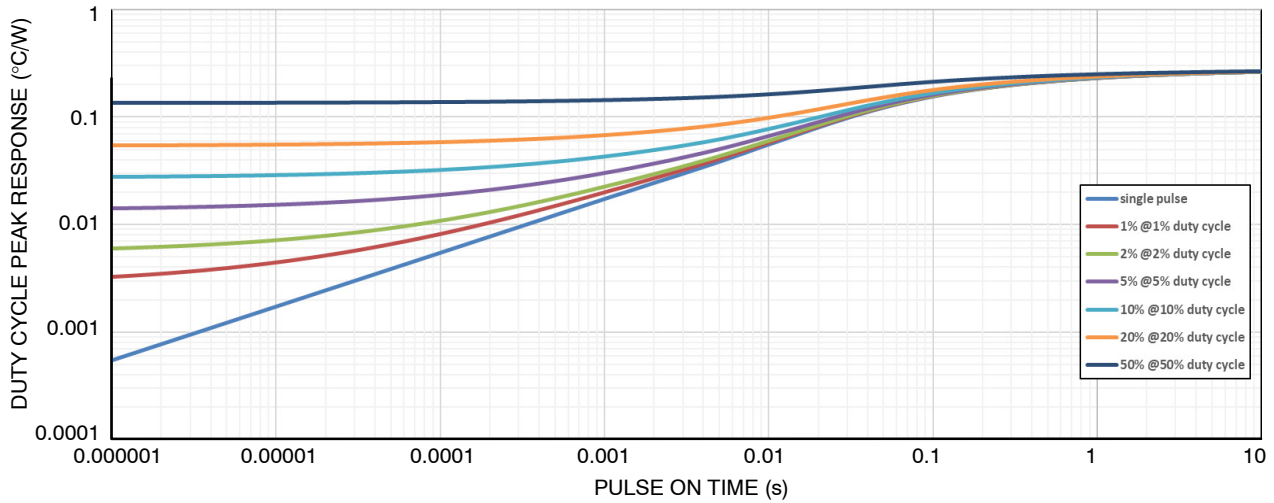

Figure 37. Transient Thermal Impedance (T5, T6)

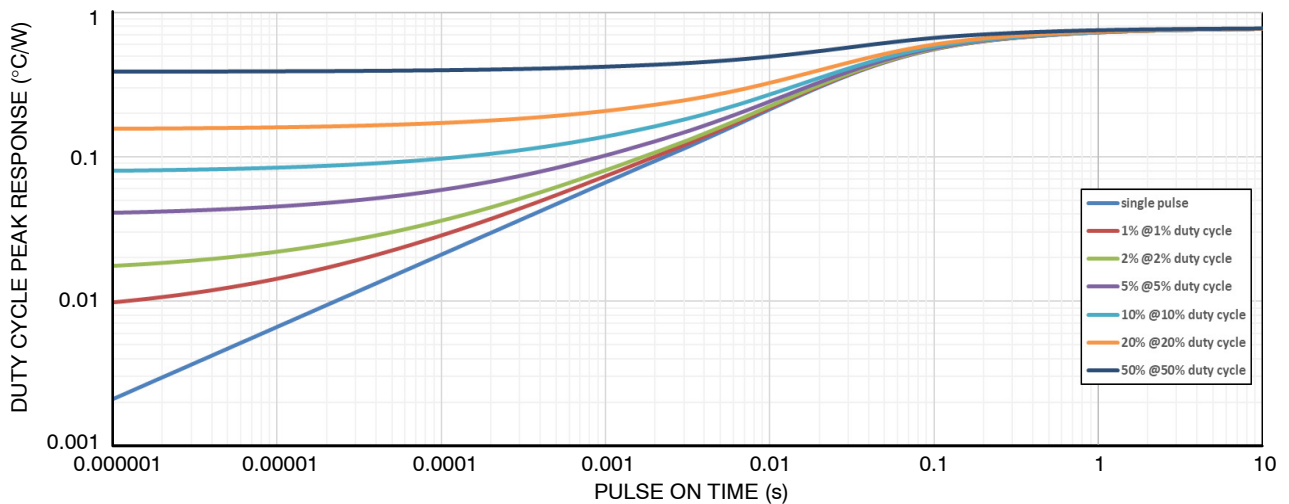

Figure 38. Transient Thermal Impedance (D1b, D2b, D3b, D4b, D5b, D6b)

NXH800A100L4Q2F2S1G/P1G, NXH800A100L4Q2F2S2G/P2G

TYPICAL CHARACTERISTICS – IGBT AND DIODE (CONTINUED)

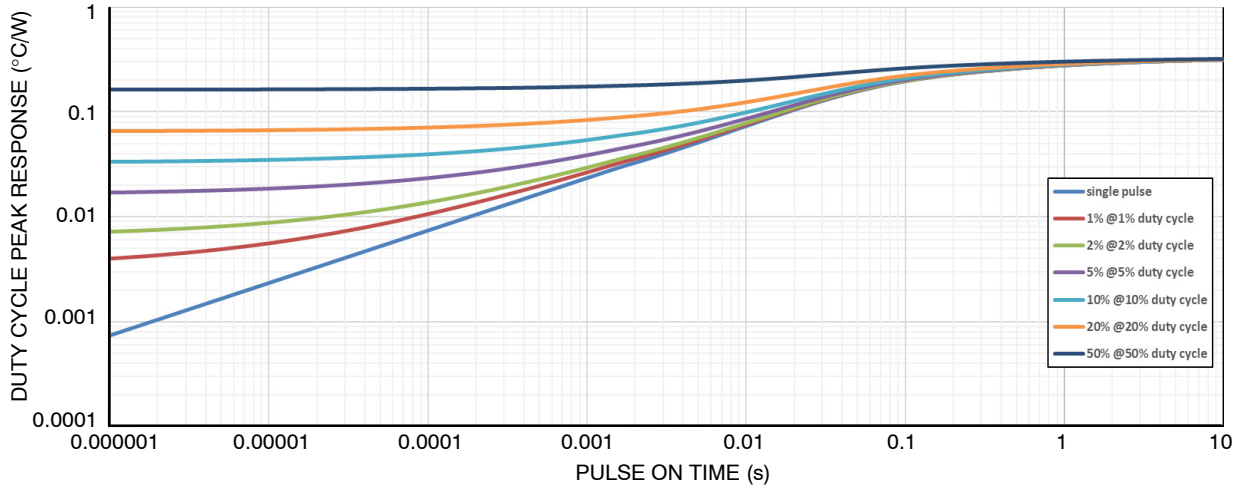

Figure 39. Transient Thermal Impedance (D1a, D2a, D3a, D4a)

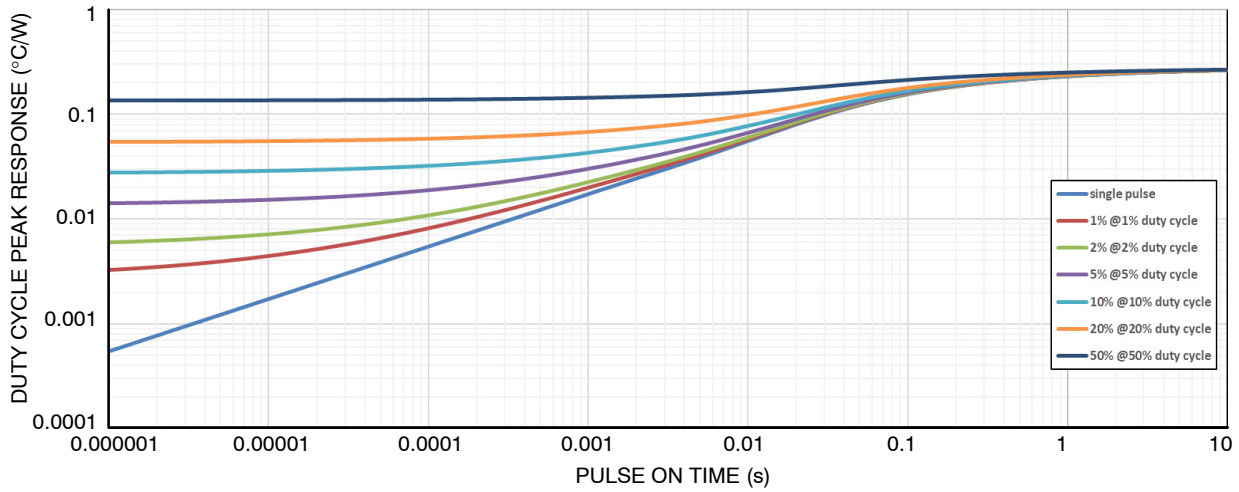

Figure 40. Transient Thermal Impedance (D5a, D6a)

TYPICAL CHARACTERISTICS – T1↵D5A OR T4↵D6A

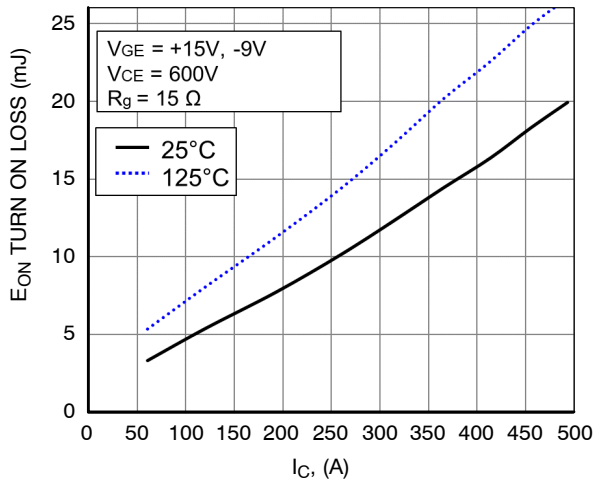

Figure 41. Typical Turn On Loss vs. I_C

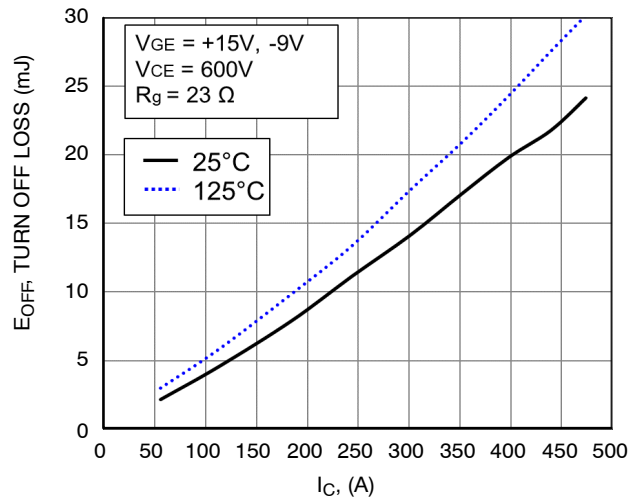

Figure 42. Typical Turn Off Loss vs. I_C

NXH800A100L4Q2F2S1G/P1G, NXH800A100L4Q2F2S2G/P2G

TYPICAL CHARACTERISTICS – T1UD5A OR T4UD6A (CONTINUED)

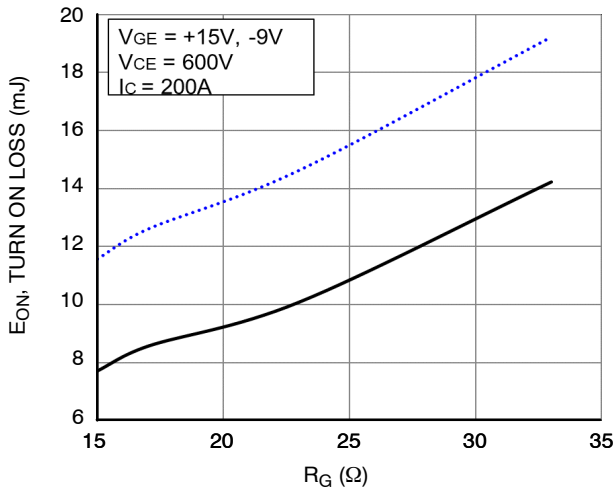

Figure 43. Typical Turn On Loss vs. R_G

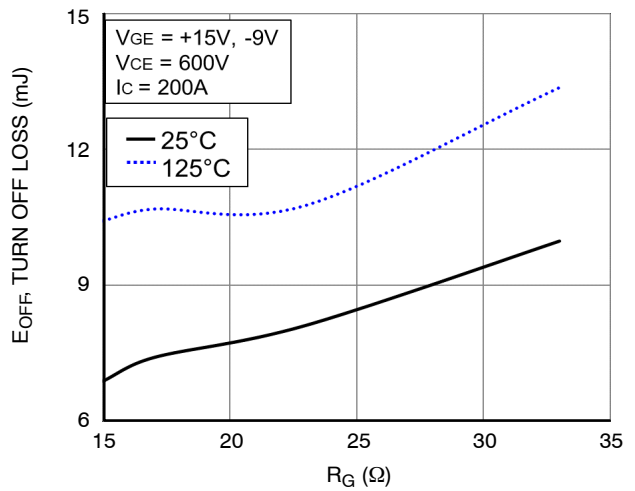

Figure 44. Typical Turn Off Loss vs. R_G

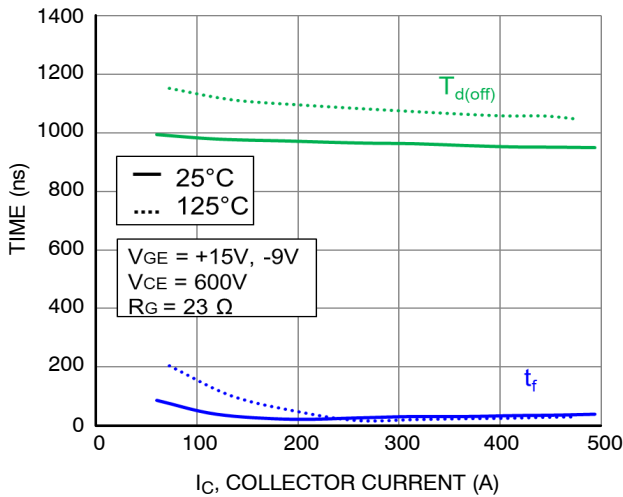

Figure 45. Typical Turn-Off Switching Time vs. I_C

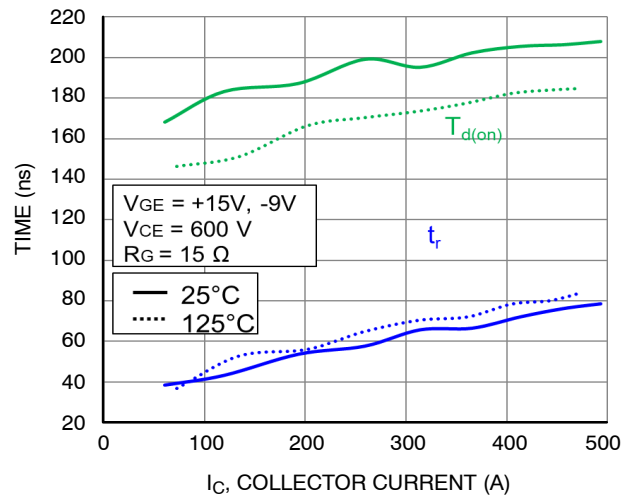

Figure 46. Typical Turn-On Switching Time vs. I_C

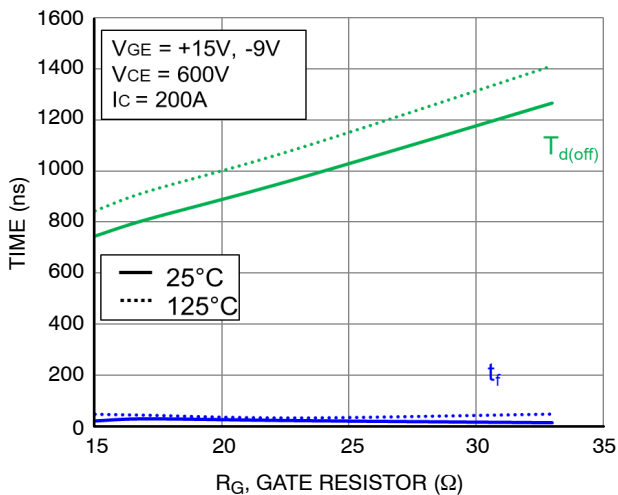

Figure 47. Typical Turn-Off Switching Time vs. R_G

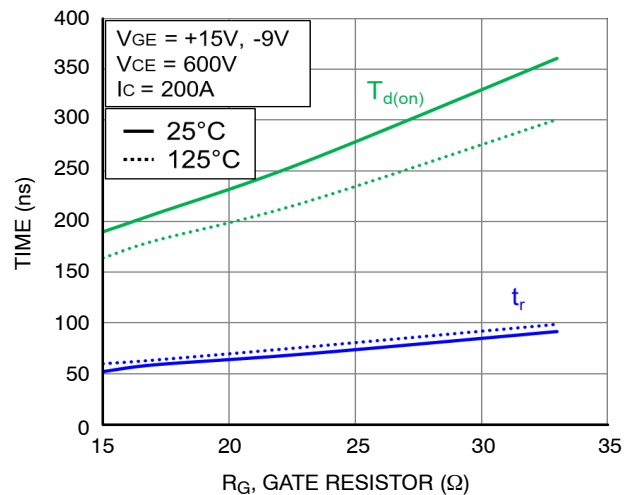

Figure 48. Typical Turn-On Switching Time vs. R_G

NXH800A100L4Q2F2S1G/P1G, NXH800A100L4Q2F2S2G/P2G

TYPICAL CHARACTERISTICS – T1D5A OR T4D6A (CONTINUED)

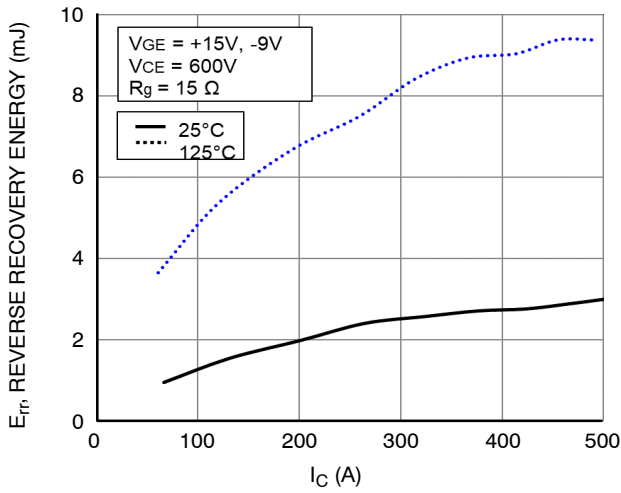

Figure 49. Typical Reverse Recovery Energy Loss vs. I_C

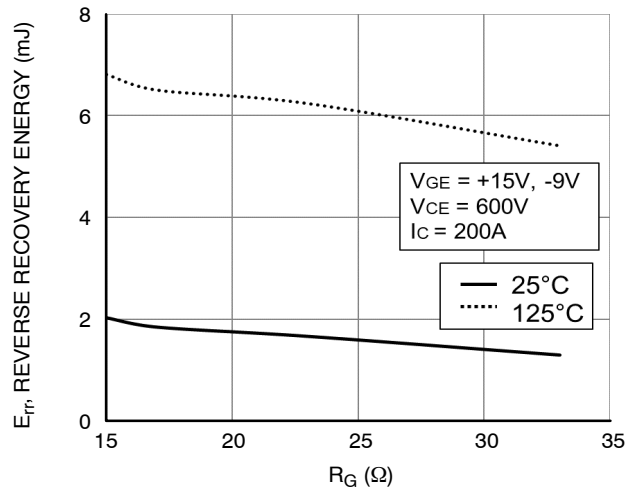

Figure 50. Typical Reverse Recovery Energy Loss vs. R_G

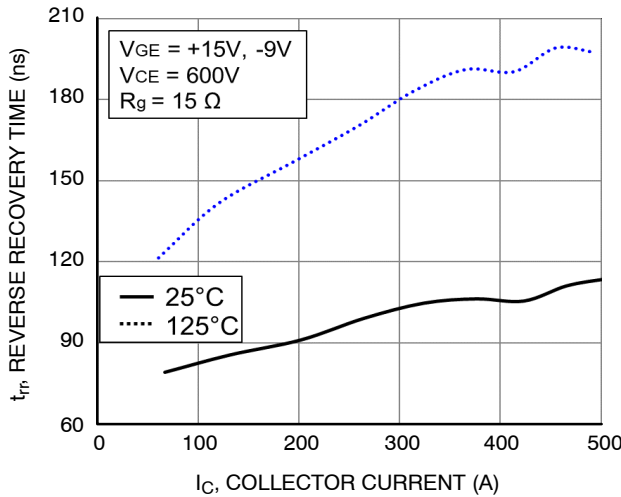

Figure 51. Typical Reverse Recovery Time vs. I_C

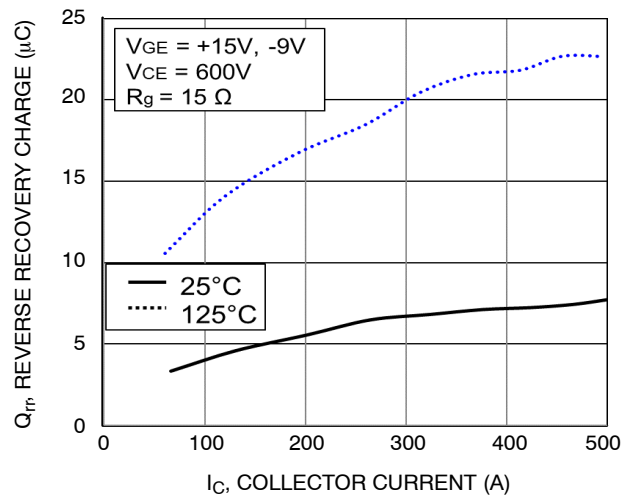

Figure 52. Typical Reverse Recovery Charge vs. I_C

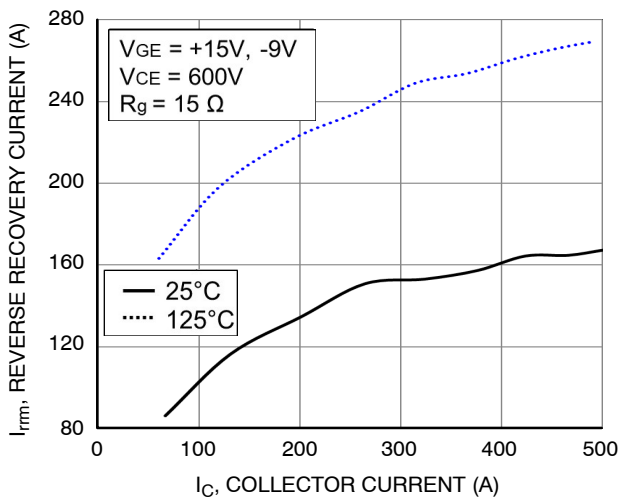

Figure 53. Typical Reverse Recovery Current vs. I_C

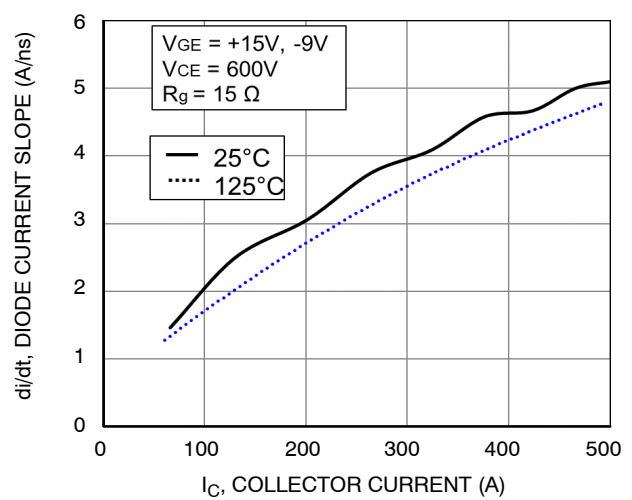

Figure 54. Typical di/dt vs. I_C

NXH800A100L4Q2F2S1G/P1G, NXH800A100L4Q2F2S2G/P2G

TYPICAL CHARACTERISTICS – T1/D5A OR T4/D6A (CONTINUED)

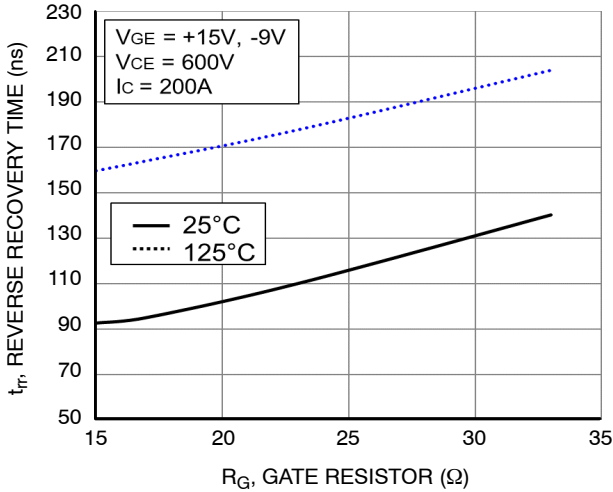

Figure 55. Typical Reverse Recovery Time vs. R_G

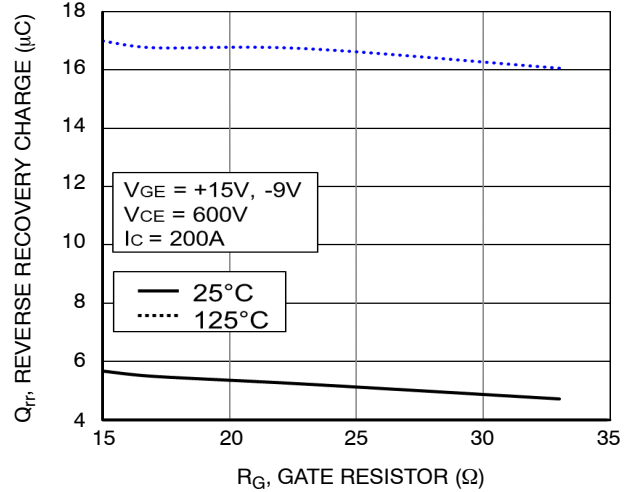

Figure 56. Typical Reverse Recovery Charge vs. R_G

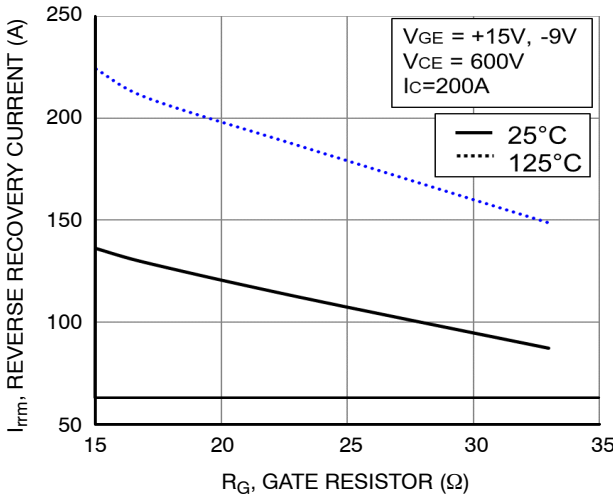

Figure 57. Typical Reverse Recovery Peak Current vs. R_G

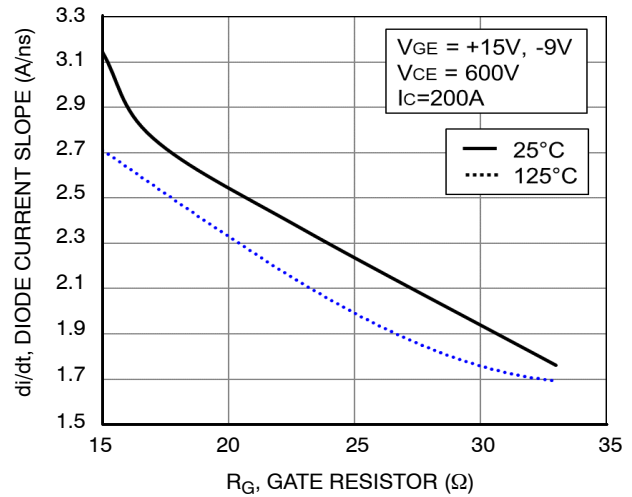

Figure 58. Typical di/dt vs. R_G

TYPICAL CHARACTERISTICS – T2/D3A + D4A OR T3/D1A + D2A

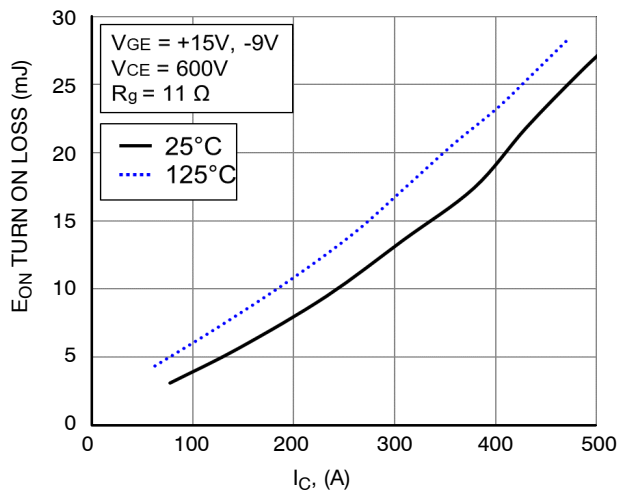

Figure 59. Typical Turn On Loss vs. I_C

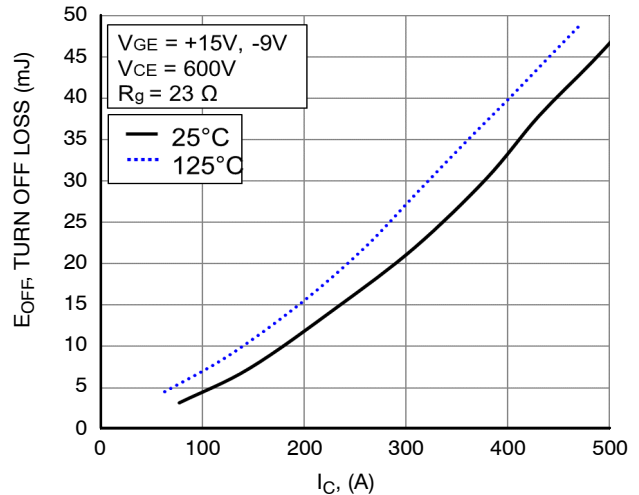

Figure 60. Typical Turn Off Loss vs. I_C

NXH800A100L4Q2F2S1G/P1G, NXH800A100L4Q2F2S2G/P2G

TYPICAL CHARACTERISTICS – T₂UD3A + D4A OR T₃UD1A + D2A (CONTINUED)

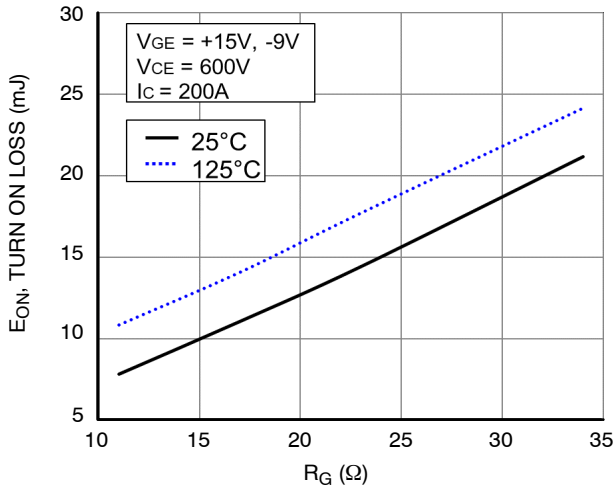

Figure 61. Typical Turn On Loss vs. R_G

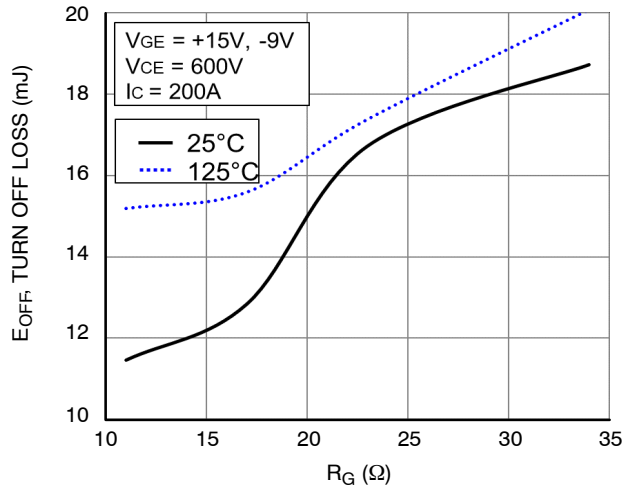

Figure 62. Typical Turn Off Loss vs. R_G

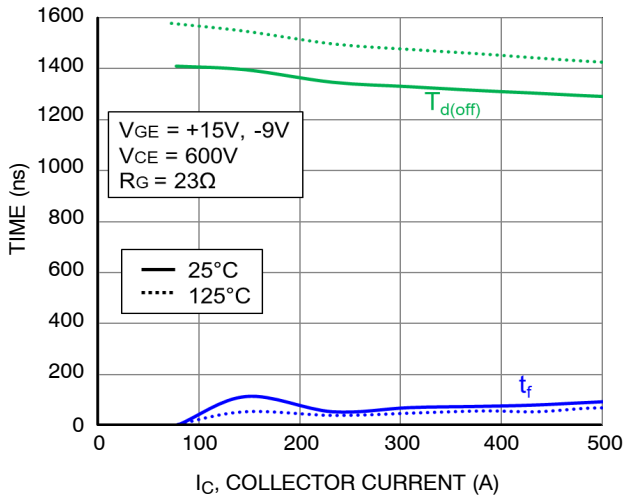

Figure 63. Typical Turn-Off Switching Time vs. I_C

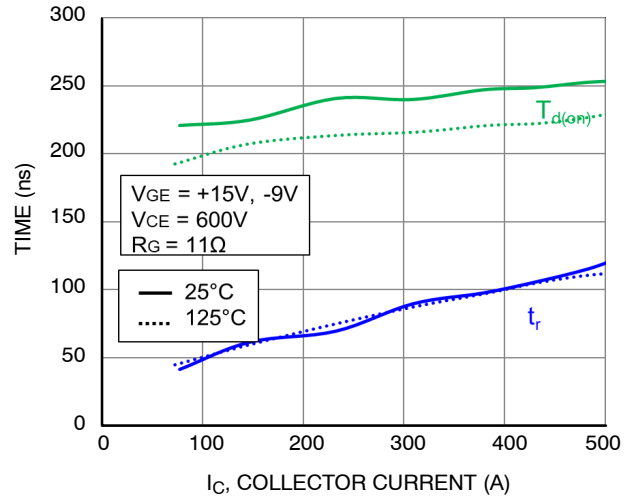

Figure 64. Typical Turn-On Switching Time vs. I_C

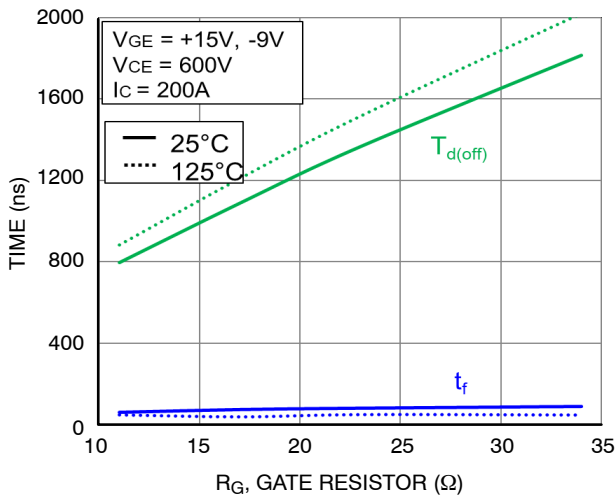

Figure 65. Typical Turn-Off Switching Time vs. R_G

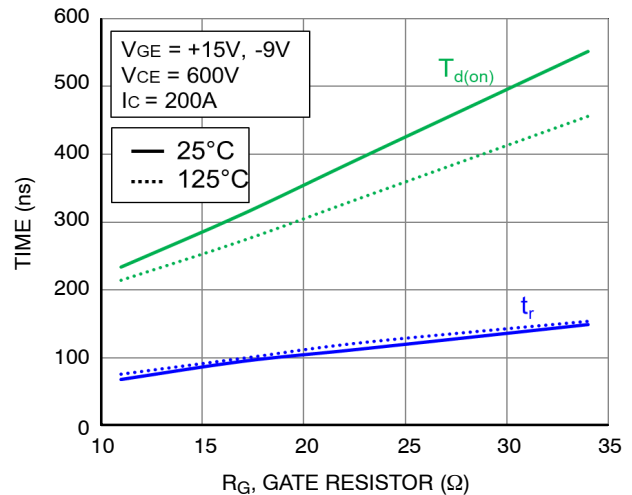

Figure 66. Typical Turn-On Switching Time vs. R_G

NXH800A100L4Q2F2S1G/P1G, NXH800A100L4Q2F2S2G/P2G

TYPICAL CHARACTERISTICS – T₂UD3A + D4A OR T3UD1A + D2A (CONTINUED)

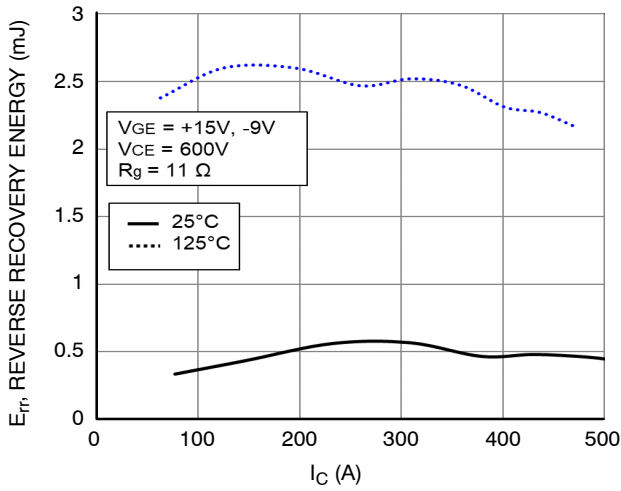

Figure 67. Typical Reverse Recovery Energy Loss vs. I_C

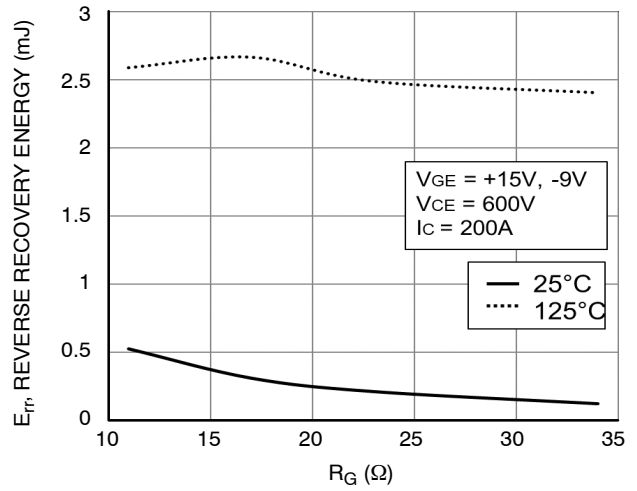

Figure 68. Typical Reverse Recovery Energy Loss vs. R_G

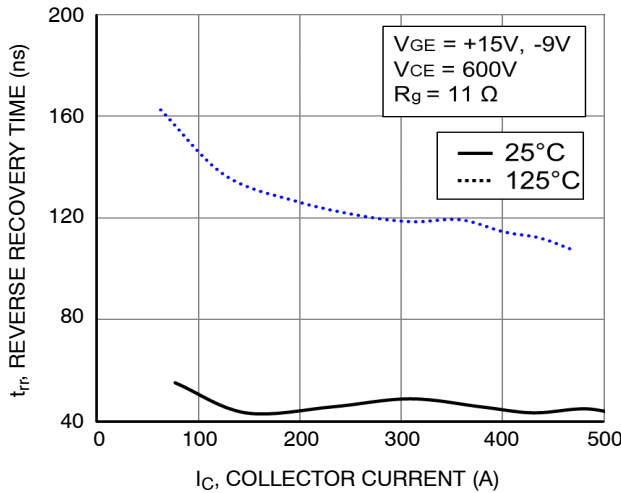

Figure 69. Typical Reverse Recovery Time vs. I_C

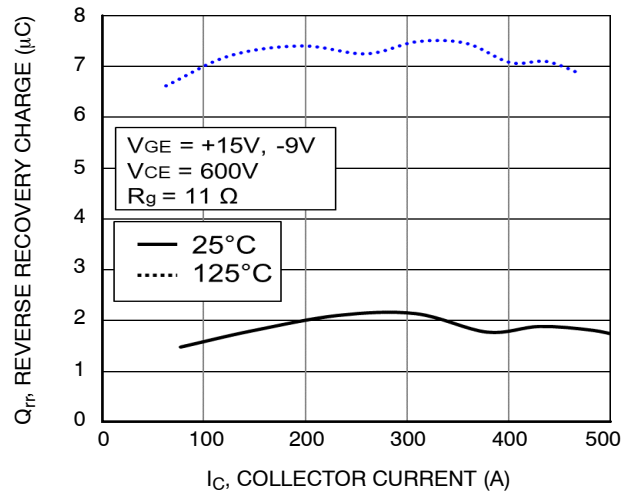

Figure 70. Typical Reverse Recovery Charge vs. I_C

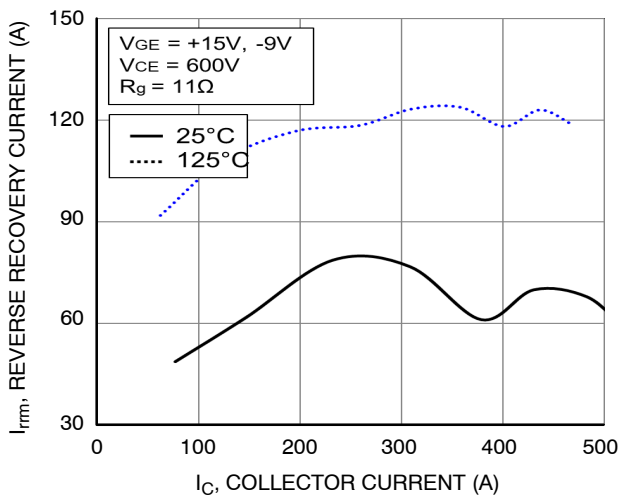

Figure 71. Typical Reverse Recovery Current vs. I_C

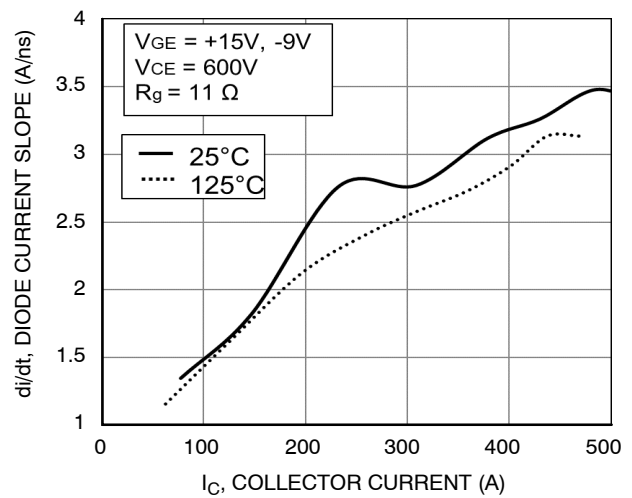

Figure 72. Typical di/dt vs. I_C

NXH800A100L4Q2F2S1G/P1G, NXH800A100L4Q2F2S2G/P2G

TYPICAL CHARACTERISTICS – T₂ D3A + D4A OR T₃ D1A + D2A (CONTINUED)

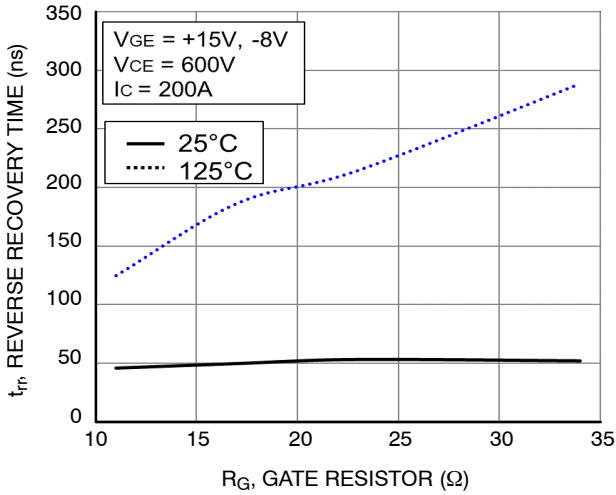

Figure 73. Typical Reverse Recovery Time vs. R_G

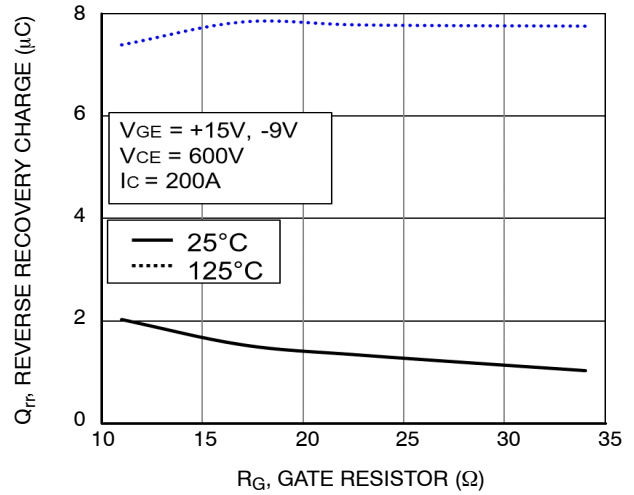

Figure 74. Typical Reverse Recovery Charge vs. R_G

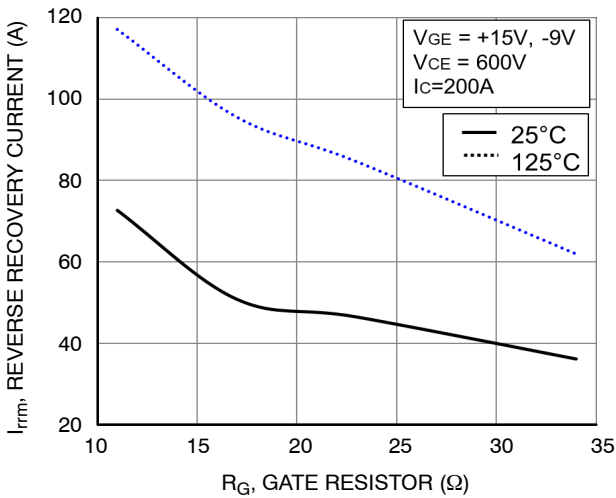

Figure 75. Typical Reverse Recovery Peak Current vs. R_G

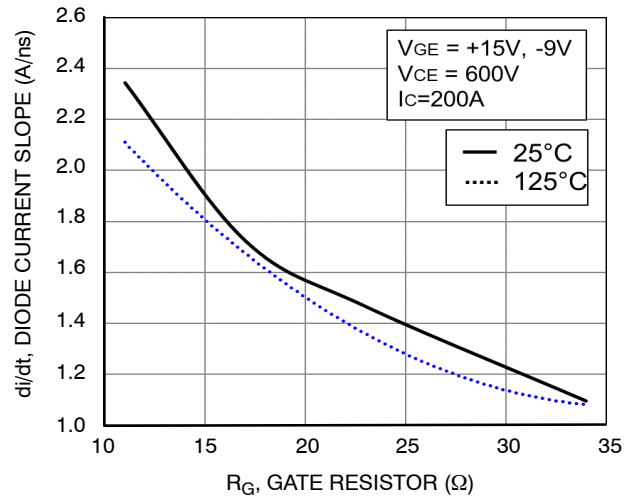

Figure 76. Typical di/dt vs. R_G

TYPICAL CHARACTERISTICS – T₆ D4A OR T₅ D1A

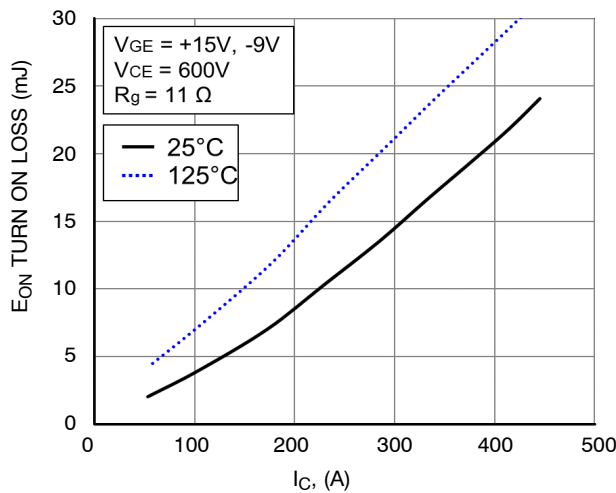

Figure 77. Typical Turn On Loss vs. I_C

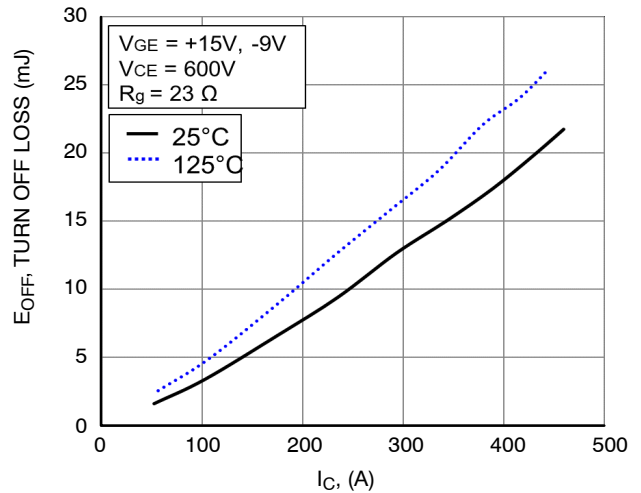

Figure 78. Typical Turn Off Loss vs. I_C

NXH800A100L4Q2F2S1G/P1G, NXH800A100L4Q2F2S2G/P2G

TYPICAL CHARACTERISTICS – T₆₀D4A OR T₅₀D1A (CONTINUED)

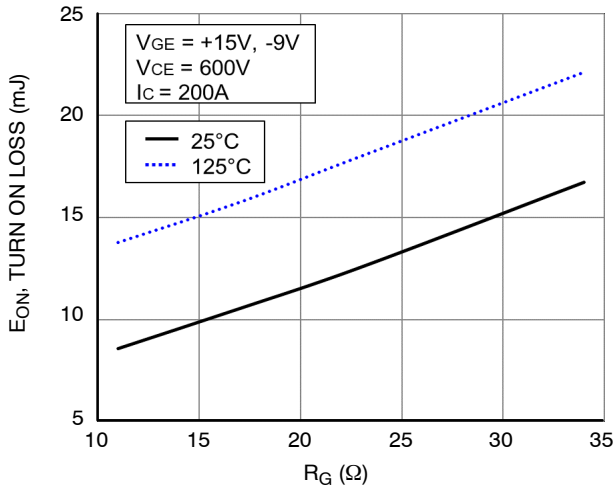

Figure 79. Typical Turn On Loss vs. R_G

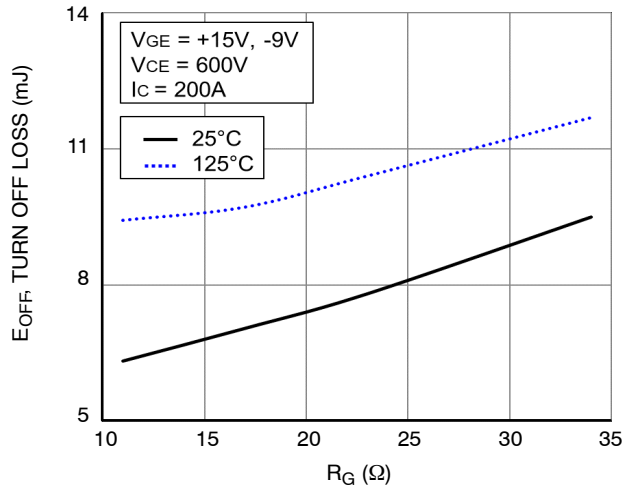

Figure 80. Typical Turn Off Loss vs. R_G

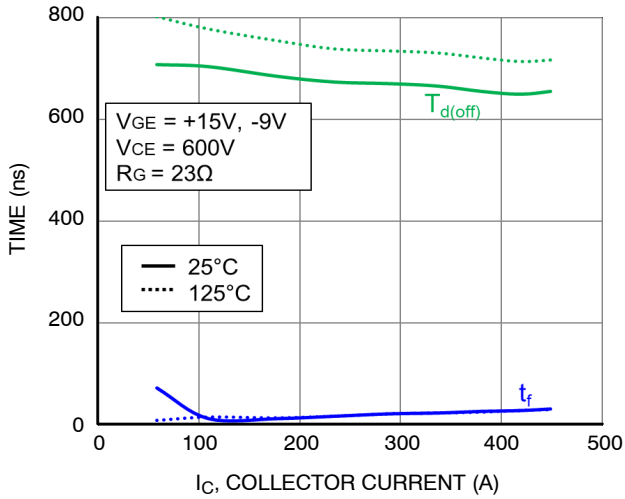

Figure 81. Typical Turn-Off Switching Time vs. I_C

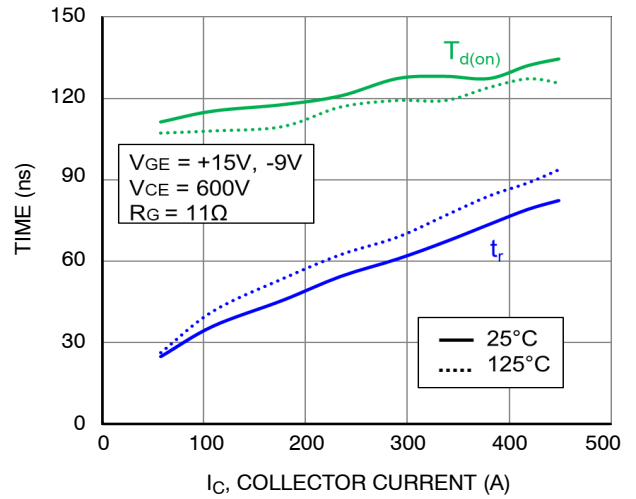

Figure 82. Typical Turn-On Switching Time vs. I_C

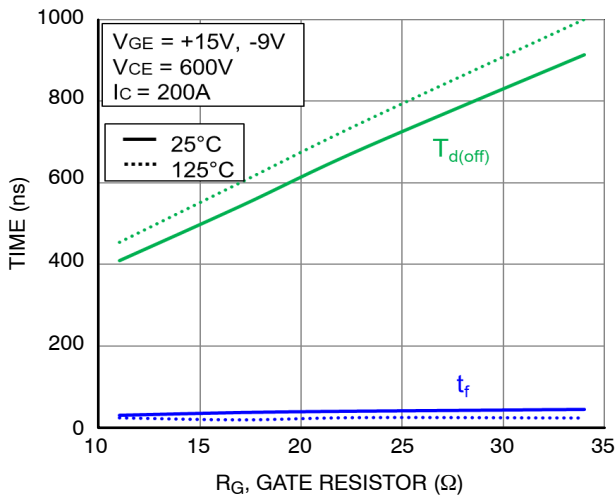

Figure 83. Typical Turn-Off Switching Time vs. R_G

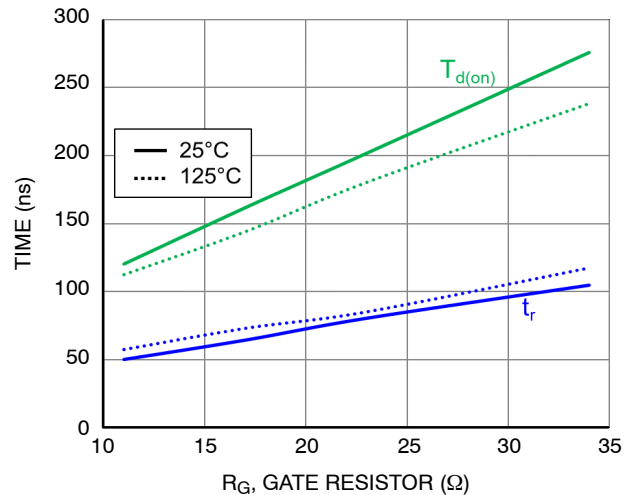

Figure 84. Typical Turn-On Switching Time vs. R_G

NXH800A100L4Q2F2S1G/P1G, NXH800A100L4Q2F2S2G/P2G

TYPICAL CHARACTERISTICS – T6UD4A OR T5UD1A (CONTINUED)

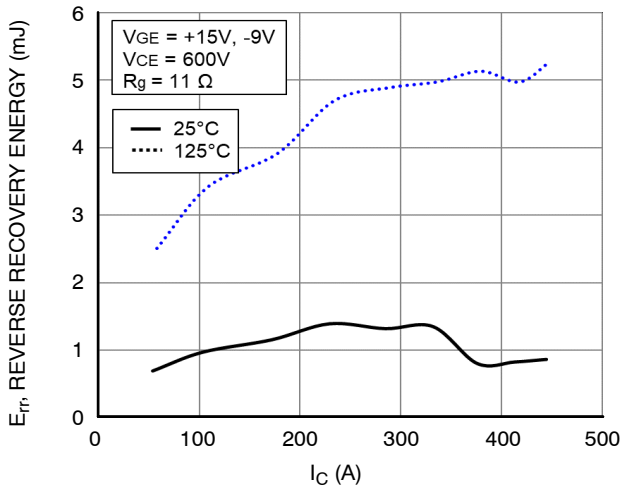

Figure 85. Typical Reverse Recovery Energy Loss vs. I_C

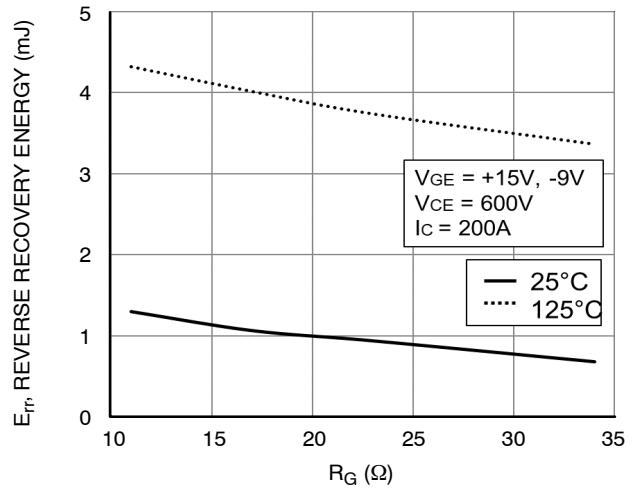

Figure 86. Typical Reverse Recovery Energy Loss vs. R_G

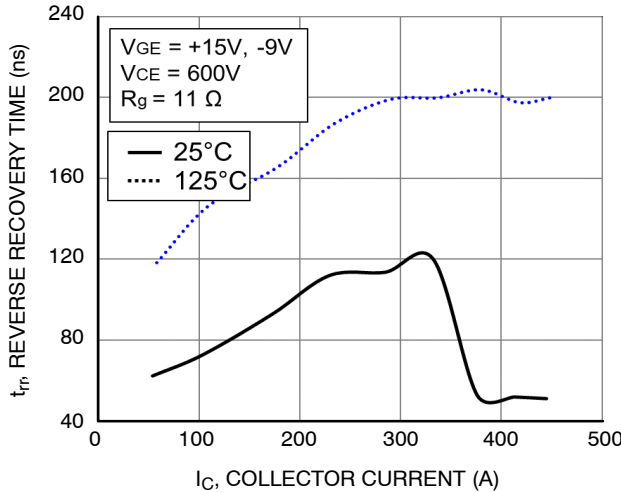

Figure 87. Typical Reverse Recovery Time vs. I_C

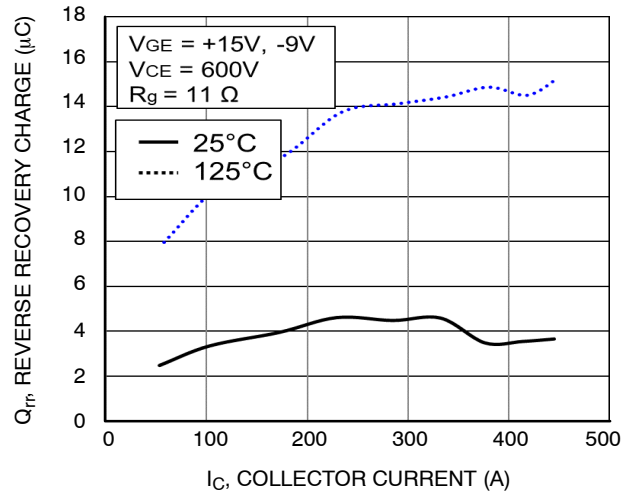

Figure 88. Typical Reverse Recovery Charge vs. I_C

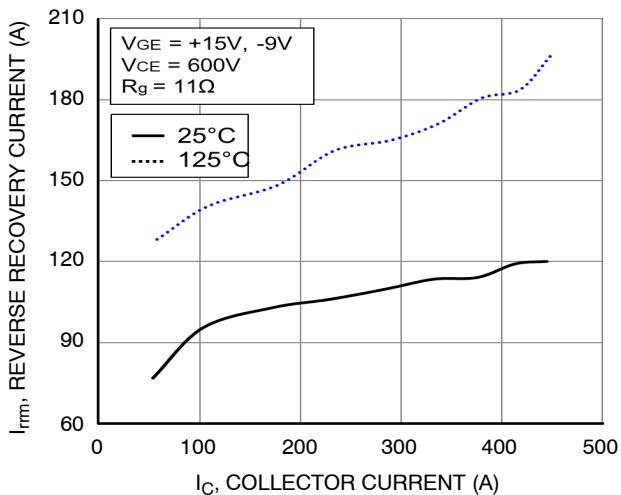

Figure 89. Typical Reverse Recovery Current vs. I_C

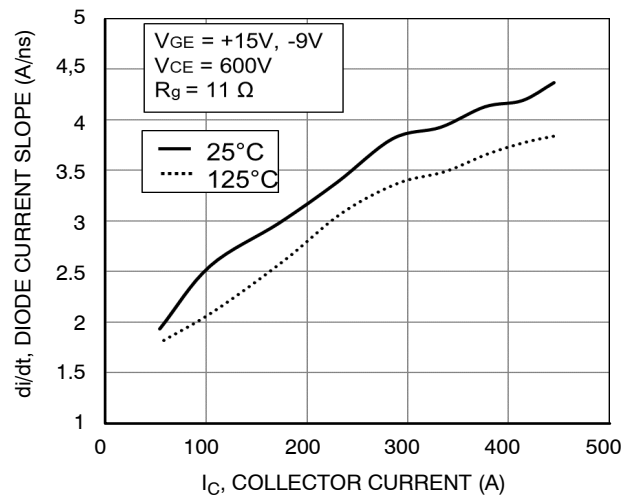

Figure 90. Typical di/dt vs. I_C

NXH800A100L4Q2F2S1G/P1G, NXH800A100L4Q2F2S2G/P2G

TYPICAL CHARACTERISTICS – T6D4A OR T5D1A (CONTINUED)

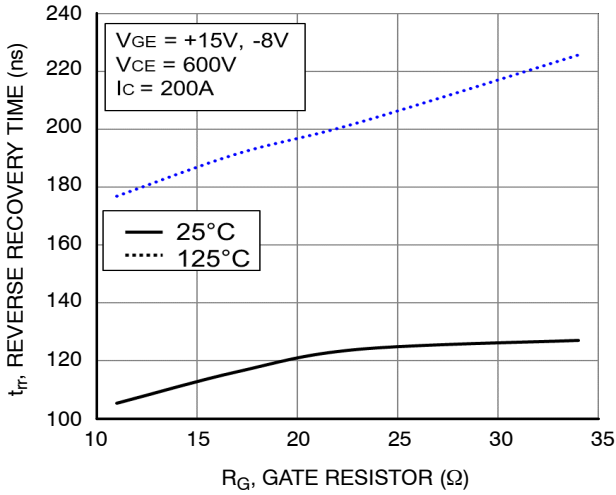

Figure 91. Typical Reverse Recovery Time vs. R_G

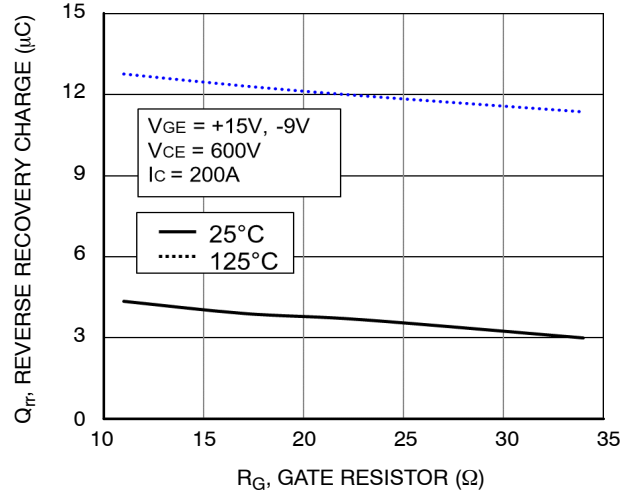

Figure 92. Typical Reverse Recovery Charge vs. R_G

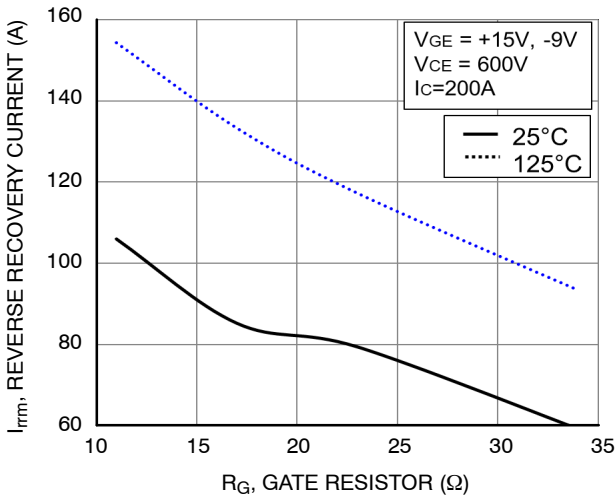

Figure 93. Typical Reverse Recovery Peak Current vs. R_G

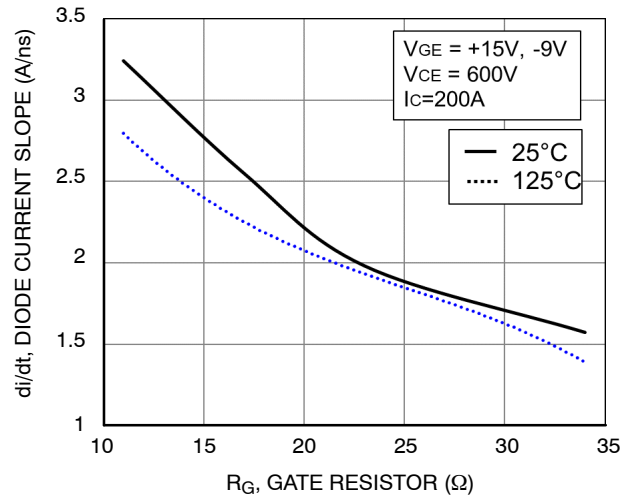
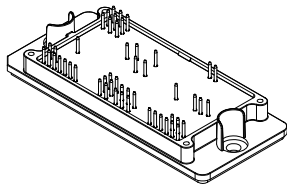

Figure 94. Typical di/dt vs. R_G

MECHANICAL CASE OUTLINE PACKAGE DIMENSIONS



**PIM51, 93x47 (SOLDER PIN)
CASE 180BM
ISSUE O**

DATE 27 OCT 2021

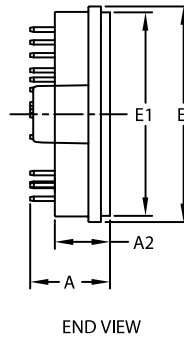
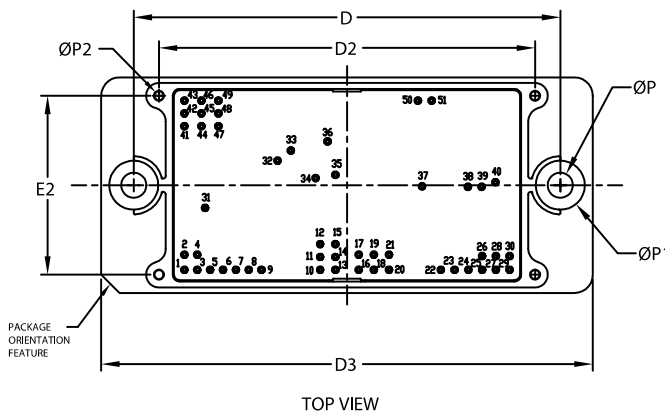
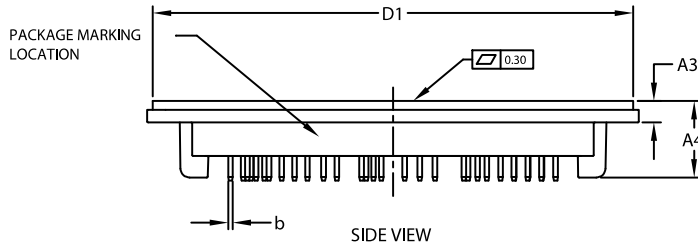

NOTES:

1. DIMENSIONING AND TOLERANCING PER ASME Y14.5M, 2009
2. CONTROLLING DIMENSION : MILLIMETERS
3. DIMENSIONS b AND b1 APPLY TO THE PLATED TERMINALS AND ARE MEASURED AT DIMENSION A1
4. PIN POSITION TOLERANCE IS $\pm 0.4\text{mm}$
5. PACKAGE MARKING IS LOCATED AS SHOWN ON THE SIDE OPPOSITE THE PACKAGE ORIENTATION FEATURES

DIM	MILLIMETERS		
	MIN.	NOM.	MAX.
A	17.00	17.40	17.80
A2	11.70	12.00	12.30
A3	4.40	4.70	5.00
A4	16.40	16.70	17.00
b	0.95	1.00	1.05
D	92.90	93.00	93.10
D1	104.45	104.75	105.05
D2	81.80	82.00	82.20
D3	106.90	107.20	107.50
E	46.70	47.00	47.30
E1	44.10	44.40	44.70
E2	38.80	39.00	39.20
P	5.40	5.50	5.60
P1	10.60	10.70	10.80
P2	1.80	2.00	2.20

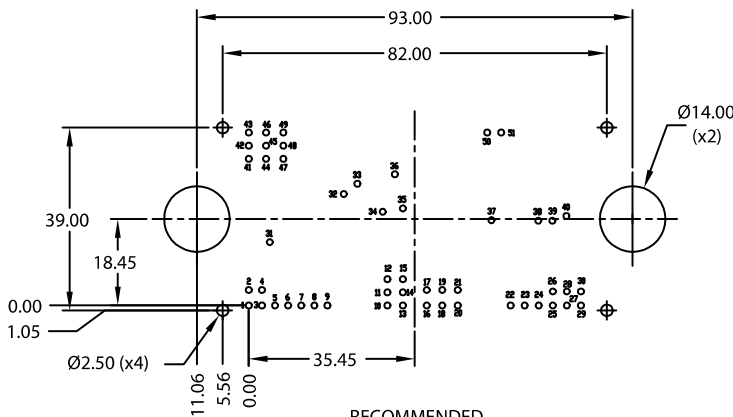

**RECOMMENDED
MOUNTING PATTERN**

* For additional information on our Pb-Free strategy and soldering details, please download the ON Semiconductor Soldering and Mounting Techniques Reference Manual, SOLDERRM/D.

NOTE 4

PIN	PIN POSITION		PIN	PIN POSITION	
	X	Y		X	Y
1	0.00	0.00	27	67.90	0.00
2	0.00	3.30	28	67.90	3.00
3	2.80	0.00	29	70.90	0.00
4	2.80	3.30	30	70.90	3.00
5	5.60	0.00	31	4.50	13.50
6	8.40	0.00	32	20.30	23.80
7	11.20	0.00	33	23.20	26.00
8	14.00	0.00	34	28.60	20.00
9	16.80	0.00	35	32.90	20.70
10	29.60	0.00	36	31.20	28.00
11	29.60	2.80	37	51.80	18.20
12	29.60	5.60	38	61.80	18.10
13	32.90	0.00	39	64.80	18.10
14	32.90	2.80	40	67.80	19.10
15	32.90	5.60	41	0.00	31.30
16	38.00	0.00	42	0.00	34.10
17	38.00	3.30	43	0.00	36.90
18	41.30	0.00	44	3.70	31.30
19	41.30	3.30	45	3.70	34.10
20	44.60	0.00	46	3.70	36.90
21	44.60	3.30	47	7.40	31.30
22	55.90	0.00	48	7.40	34.10
23	58.90	0.00	49	7.40	36.90
24	61.90	0.00	50	50.90	36.90
25	64.90	0.00	51	53.90	36.90
26	64.90	3.00			

DOCUMENT NUMBER:	98AON39387H	Electronic versions are uncontrolled except when accessed directly from the Document Repository. Printed versions are uncontrolled except when stamped "CONTROLLED COPY" in red.
DESCRIPTION:	PIM51 93X47 (SOLDER PIN)	PAGE 1 OF 2

onsemi and ONSEMI are trademarks of Semiconductor Components Industries, LLC dba onsemi or its subsidiaries in the United States and/or other countries. onsemi reserves the right to make changes without further notice to any products herein. onsemi makes no warranty, representation or guarantee regarding the suitability of its products for any particular purpose, nor does onsemi assume any liability arising out of the application or use of any product or circuit, and specifically disclaims any and all liability, including without limitation special, consequential or incidental damages. onsemi does not convey any license under its patent rights nor the rights of others.

PIM51, 93x47 (SOLDER PIN)
CASE 180BM
ISSUE 0

DATE 27 OCT 2021

GENERIC MARKING DIAGRAM*

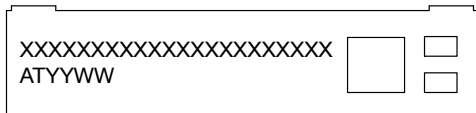

FRONTSIDE MARKING

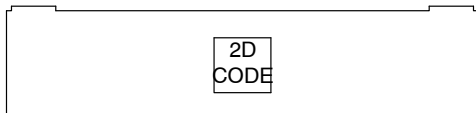

BACKSIDE MARKING

XXXXX = Specific Device Code
 AT = Assembly & Test Site Code
 YYWW = Year and Work Week Code

*This information is generic. Please refer to device data sheet for actual part marking. Pb-Free indicator, "G" or microdot "▪", may or may not be present. Some products may not follow the Generic Marking.

DOCUMENT NUMBER:	98AON39387H	Electronic versions are uncontrolled except when accessed directly from the Document Repository. Printed versions are uncontrolled except when stamped "CONTROLLED COPY" in red.
DESCRIPTION:	PIM51 93X47 (SOLDER PIN)	PAGE 2 OF 2

onsemi and **ONSEMI** are trademarks of Semiconductor Components Industries, LLC dba **onsemi** or its subsidiaries in the United States and/or other countries. **onsemi** reserves the right to make changes without further notice to any products herein. **onsemi** makes no warranty, representation or guarantee regarding the suitability of its products for any particular purpose, nor does **onsemi** assume any liability arising out of the application or use of any product or circuit, and specifically disclaims any and all liability, including without limitation special, consequential or incidental damages. **onsemi** does not convey any license under its patent rights nor the rights of others.

MECHANICAL CASE OUTLINE PACKAGE DIMENSIONS

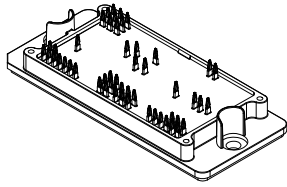

**PIM51, 93x47 (PRESS FIT)
CASE 180CQ
ISSUE O**

DATE 28 OCT 2021

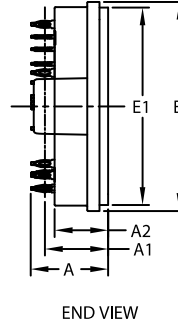
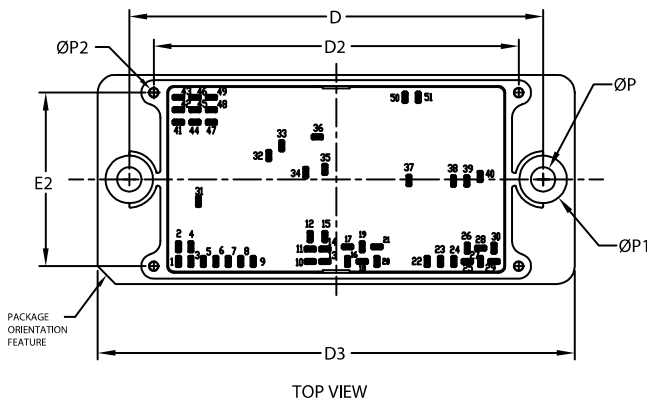
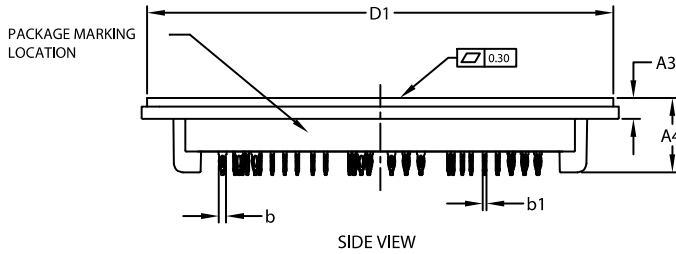

NOTES:

1. DIMENSIONING AND TOLERANCING PER ASME Y14.5M, 2009
2. CONTROLLING DIMENSION: MILLIMETERS
3. DIMENSIONS b AND b1 APPLY TO THE PLATED TERMINALS AND ARE MEASURED AT DIMENSION A1
4. PIN POSITION TOLERANCE IS $\pm 0.4\text{mm}$
5. PACKAGE MARKING IS LOCATED AS SHOWN ON THE SIDE OPPOSITE THE PACKAGE ORIENTATION FEATURES

DIM	MILLIMETERS		
	MIN.	NOM.	MAX.
A	16.90	17.30	17.70
A1	14.18(REF)		
A2	11.70	12.00	12.30
A3	4.40	4.70	5.00
A4	16.40	16.70	17.00
b	1.61	1.66	1.71
b1	0.75	0.80	0.85
D	92.90	93.00	93.10
D1	104.45	104.75	105.05
D2	81.80	82.00	82.20
D3	106.90	107.20	107.50
E	46.70	47.00	47.30
E1	44.10	44.40	44.70
E2	38.80	39.00	39.20
P	5.40	5.50	5.60
P1	10.60	10.70	10.80
P2	1.80	2.00	2.20

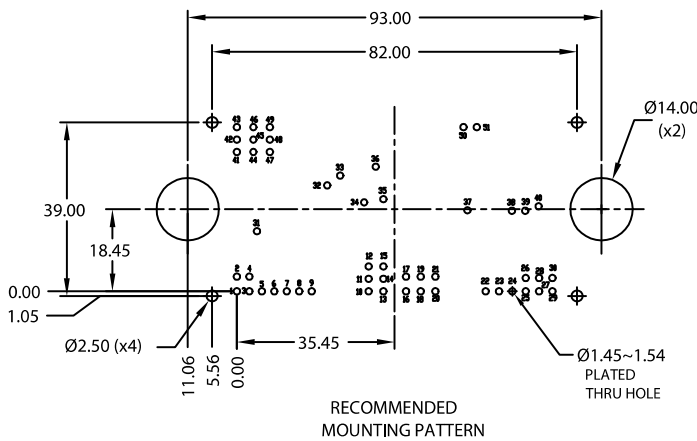

NOTE 4

PIN	PIN POSITION		PIN	PIN POSITION	
	X	Y		X	Y
1	0.00	0.00	27	67.90	0.00
2	0.00	3.30	28	67.90	3.00
3	2.80	0.00	29	70.90	0.00
4	2.80	3.30	30	70.90	3.00
5	5.60	0.00	31	4.50	13.50
6	8.40	0.00	32	20.30	23.80
7	11.20	0.00	33	23.20	26.00
8	14.00	0.00	34	28.60	20.00
9	16.80	0.00	35	32.90	20.70
10	29.60	0.00	36	31.20	28.00
11	29.60	2.80	37	51.80	18.20
12	29.60	5.60	38	61.80	18.10
13	32.90	0.00	39	64.80	18.10
14	32.90	2.80	40	67.80	19.10
15	32.90	5.60	41	0.00	31.30
16	38.00	0.00	42	0.00	34.10
17	38.00	3.30	43	0.00	36.90
18	41.30	0.00	44	3.70	31.30
19	41.30	3.30	45	3.70	34.10
20	44.60	0.00	46	3.70	36.90
21	44.60	3.30	47	7.40	31.30
22	55.90	0.00	48	7.40	34.10
23	58.90	0.00	49	7.40	36.90
24	61.90	0.00	50	50.90	36.90
25	64.90	0.00	51	53.90	36.90
26	64.90	3.00			

DOCUMENT NUMBER:	98AON39256H	Electronic versions are uncontrolled except when accessed directly from the Document Repository. Printed versions are uncontrolled except when stamped "CONTROLLED COPY" in red.
DESCRIPTION:	PIM51 93X47 (PRESS FIT)	PAGE 1 OF 2

onsemi and ONSEMI are trademarks of Semiconductor Components Industries, LLC dba onsemi or its subsidiaries in the United States and/or other countries. onsemi reserves the right to make changes without further notice to any products herein. onsemi makes no warranty, representation or guarantee regarding the suitability of its products for any particular purpose, nor does onsemi assume any liability arising out of the application or use of any product or circuit, and specifically disclaims any and all liability, including without limitation special, consequential or incidental damages. onsemi does not convey any license under its patent rights nor the rights of others.

PIM51, 93x47 (PRESS FIT)
CASE 180CQ
ISSUE 0

DATE 30 OCT 2021

GENERIC MARKING DIAGRAM*

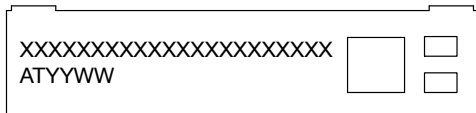

FRONTSIDE MARKING

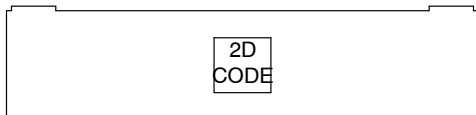

BACKSIDE MARKING

XXXXX = Specific Device Code
AT = Assembly & Test Site Code
YYWW = Year and Work Week Code

*This information is generic. Please refer to device data sheet for actual part marking. Pb-Free indicator, "G" or microdot "▪", may or may not be present. Some products may not follow the Generic Marking.

DOCUMENT NUMBER:	98AON39256H	Electronic versions are uncontrolled except when accessed directly from the Document Repository. Printed versions are uncontrolled except when stamped "CONTROLLED COPY" in red.
DESCRIPTION:	PIM51 93X47 (PRESS FIT)	PAGE 2 OF 2

onsemi and **ONSEMI** are trademarks of Semiconductor Components Industries, LLC dba **onsemi** or its subsidiaries in the United States and/or other countries. **onsemi** reserves the right to make changes without further notice to any products herein. **onsemi** makes no warranty, representation or guarantee regarding the suitability of its products for any particular purpose, nor does **onsemi** assume any liability arising out of the application or use of any product or circuit, and specifically disclaims any and all liability, including without limitation special, consequential or incidental damages. **onsemi** does not convey any license under its patent rights nor the rights of others.

MECHANICAL CASE OUTLINE PACKAGE DIMENSIONS

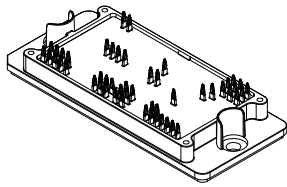

**PIM51, 93x47 (PRESS FIT)
CASE 180HG
ISSUE O**

DATE 10 NOV 2021

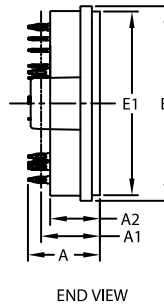
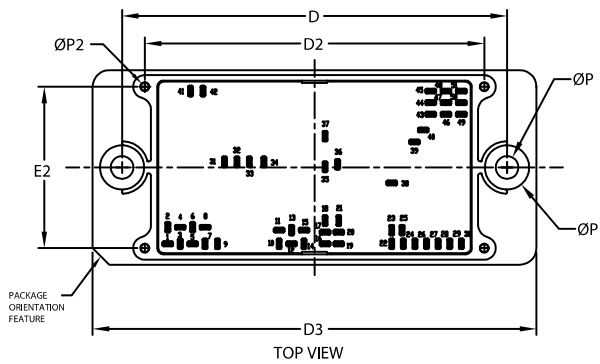
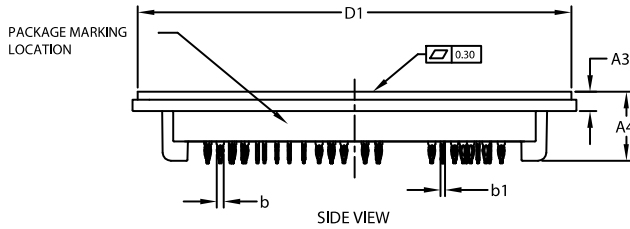

NOTES:

1. DIMENSIONING AND TOLERANCING PER ASME Y14.5M, 2009
2. CONTROLLING DIMENSION : MILLIMETERS
3. DIMENSIONS b AND b1 APPLY TO THE PLATED TERMINALS AND ARE MEASURED AT DIMENSION A1
4. PIN POSITION TOLERANCE IS $\pm 0.4\text{mm}$
5. PACKAGE MARKING IS LOCATED AS SHOWN ON THE SIDE OPPOSITE THE PACKAGE ORIENTATION FEATURES

DIM	MILLIMETERS		
	MIN.	NOM.	MAX.
A	16.90	17.30	17.70
A1	14.18(REF)		
A2	11.70	12.00	12.30
A3	4.40	4.70	5.00
A4	16.40	16.70	17.00
b	1.61	1.66	1.71
b1	0.75	0.80	0.85
D	92.90	93.00	93.10
D1	104.45	104.75	105.05
D2	81.80	82.00	82.20
D3	106.90	107.20	107.50
E	46.70	47.00	47.30
E1	44.10	44.40	44.70
E2	38.80	39.00	39.20
P	5.40	5.50	5.60
P1	10.60	10.70	10.80
P2	1.80	2.00	2.20

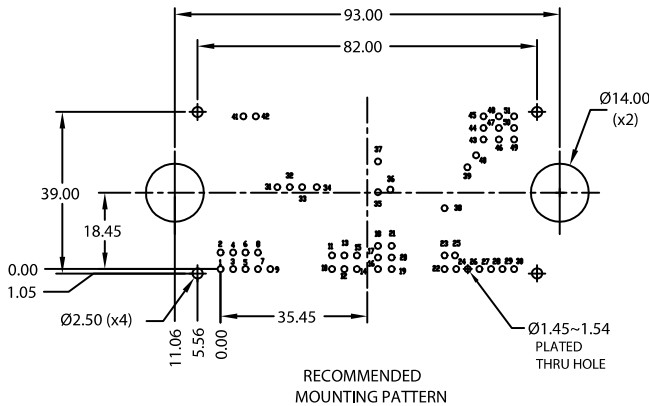

NOTE 4

PIN	PIN POSITION		PIN	PIN POSITION	
	X	Y		X	Y
1	0.00	0.00	27	62.50	0.00
2	0.00	4.00	28	65.30	0.00
3	3.00	0.00	29	68.10	0.00
4	3.00	4.00	30	70.90	0.00
5	6.00	0.00	31	13.70	19.80
6	6.00	4.00	32	16.70	19.80
7	9.00	0.00	33	19.70	19.80
8	9.00	4.00	34	23.20	19.80
9	12.00	0.00	35	38.00	18.60
10	26.90	0.00	36	41.00	19.20
11	26.90	3.30	37	38.00	26.00
12	29.90	0.00	38	54.10	14.70
13	29.90	3.30	39	59.60	24.60
14	32.90	0.00	40	61.70	27.50
15	32.90	3.30	41	5.50	36.90
16	38.00	0.00	42	8.50	36.90
17	38.00	2.80	43	63.50	31.30
18	38.00	5.60	44	63.50	34.10
19	41.30	0.00	45	63.50	36.90
20	41.30	2.80	46	67.20	31.30
21	41.30	5.60	47	67.20	34.10
22	54.10	0.00	48	67.20	36.90
23	54.10	3.30	49	70.90	31.30
24	56.90	0.00	50	70.90	34.10
25	56.60	3.30	51	70.90	36.90
26	59.70	0.00			

DOCUMENT NUMBER:	98AON39438H	Electronic versions are uncontrolled except when accessed directly from the Document Repository. Printed versions are uncontrolled except when stamped "CONTROLLED COPY" in red.
DESCRIPTION:	PIM51 93X47 (PRESS FIT)	PAGE 1 OF 2

onsemi and ONSEMI are trademarks of Semiconductor Components Industries, LLC dba onsemi or its subsidiaries in the United States and/or other countries. onsemi reserves the right to make changes without further notice to any products herein. onsemi makes no warranty, representation or guarantee regarding the suitability of its products for any particular purpose, nor does onsemi assume any liability arising out of the application or use of any product or circuit, and specifically disclaims any and all liability, including without limitation special, consequential or incidental damages. onsemi does not convey any license under its patent rights nor the rights of others.

PIM51, 93x47 (PRESS FIT)
CASE 180HG
ISSUE 0

DATE 08 NOV 2021

GENERIC MARKING DIAGRAM*

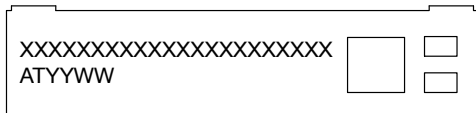

FRONTSIDE MARKING

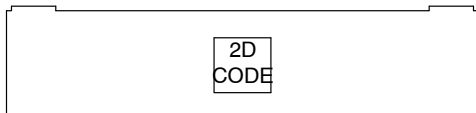

BACKSIDE MARKING

XXXXX = Specific Device Code
AT = Assembly & Test Site Code
YYWW = Year and Work Week Code

*This information is generic. Please refer to device data sheet for actual part marking. Pb-Free indicator, "G" or microdot "▪", may or may not be present. Some products may not follow the Generic Marking.

DOCUMENT NUMBER:	98AON39438H	Electronic versions are uncontrolled except when accessed directly from the Document Repository. Printed versions are uncontrolled except when stamped "CONTROLLED COPY" in red.
DESCRIPTION:	PIM51 93X47 (PRESS FIT)	PAGE 2 OF 2

onsemi and **ONSEMI** are trademarks of Semiconductor Components Industries, LLC dba **onsemi** or its subsidiaries in the United States and/or other countries. **onsemi** reserves the right to make changes without further notice to any products herein. **onsemi** makes no warranty, representation or guarantee regarding the suitability of its products for any particular purpose, nor does **onsemi** assume any liability arising out of the application or use of any product or circuit, and specifically disclaims any and all liability, including without limitation special, consequential or incidental damages. **onsemi** does not convey any license under its patent rights nor the rights of others.

MECHANICAL CASE OUTLINE PACKAGE DIMENSIONS

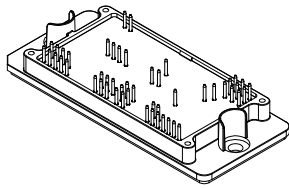

PIM51, 93x47 (SOLDER PIN) CASE 180HH ISSUE O

DATE 16 NOV 2021

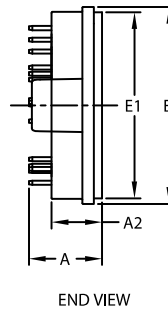
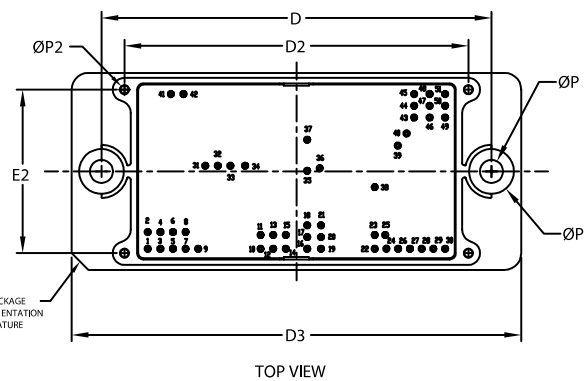
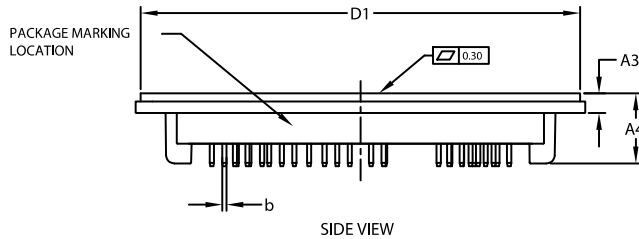

NOTES:

1. DIMENSIONING AND TOLERANCING PER ASME Y14.5M, 2009
2. CONTROLLING DIMENSION : MILLIMETERS
3. DIMENSIONS b AND b1 APPLY TO THE PLATED TERMINALS AND ARE MEASURED AT DIMENSION A1
4. PIN POSITION TOLERANCE IS $\pm 0.4\text{mm}$
5. PACKAGE MARKING IS LOCATED AS SHOWN ON THE SIDE OPPOSITE THE PACKAGE ORIENTATION FEATURES

DIM	MILLIMETERS		
	MIN.	NOM.	MAX.
A	17.00	17.40	17.80
A2	11.70	12.00	12.30
A3	4.40	4.70	5.00
A4	16.40	16.70	17.00
b	0.95	1.00	1.05
D	92.90	93.00	93.10
D1	104.45	104.75	105.05
D2	81.80	82.00	82.20
D3	106.90	107.20	107.50
E	46.70	47.00	47.30
E1	44.10	44.40	44.70
E2	38.80	39.00	39.20
P	5.40	5.50	5.60
P1	10.60	10.70	10.80
P2	1.80	2.00	2.20

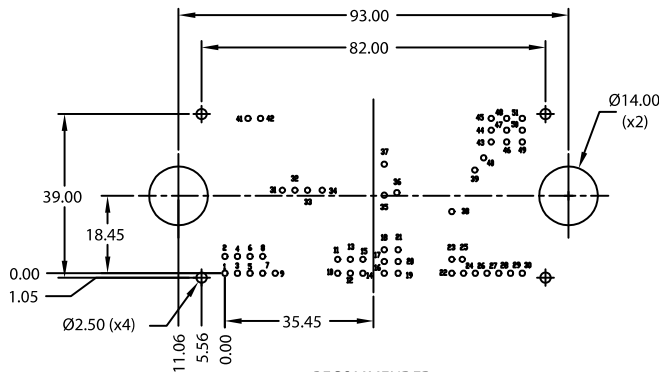

RECOMMENDED
MOUNTING PATTERN

* For additional information on our Pb-Free strategy and soldering details, please download the ON Semiconductor Soldering and Mounting Techniques Reference Manual, SOLDERM/D.

NOTE 4

PIN	PIN POSITION		PIN	PIN POSITION	
	X	Y		X	Y
1	0.00	0.00	27	62.50	0.00
2	0.00	4.00	28	65.30	0.00
3	3.00	0.00	29	68.10	0.00
4	3.00	4.00	30	70.90	0.00
5	6.00	0.00	31	13.70	19.80
6	6.00	4.00	32	16.70	19.80
7	9.00	0.00	33	19.70	19.80
8	9.00	4.00	34	23.20	19.80
9	12.00	0.00	35	38.00	18.60
10	26.90	0.00	36	41.00	19.20
11	26.90	3.30	37	38.00	26.00
12	29.90	0.00	38	54.10	14.70
13	29.90	3.30	39	59.60	24.60
14	32.90	0.00	40	61.70	27.50
15	32.90	3.30	41	5.50	36.90
16	38.00	0.00	42	8.50	36.90
17	38.00	2.80	43	63.50	31.30
18	38.00	5.60	44	63.50	34.10
19	41.30	0.00	45	63.50	36.90
20	41.30	2.80	46	67.20	31.30
21	41.30	5.60	47	67.20	34.10
22	54.10	0.00	48	67.20	36.90
23	54.10	3.30	49	70.90	31.30
24	56.90	0.00	50	70.90	34.10
25	56.60	3.30	51	70.90	36.90
26	59.70	0.00			

DOCUMENT NUMBER:	98AON39619H	Electronic versions are uncontrolled except when accessed directly from the Document Repository. Printed versions are uncontrolled except when stamped "CONTROLLED COPY" in red.
DESCRIPTION:	PIM51 93X47 (SOLDER PIN)	PAGE 1 OF 2

onsemi and ONSEMI are trademarks of Semiconductor Components Industries, LLC dba onsemi or its subsidiaries in the United States and/or other countries. onsemi reserves the right to make changes without further notice to any products herein. onsemi makes no warranty, representation or guarantee regarding the suitability of its products for any particular purpose, nor does onsemi assume any liability arising out of the application or use of any product or circuit, and specifically disclaims any and all liability, including without limitation special, consequential or incidental damages. onsemi does not convey any license under its patent rights nor the rights of others.

PIM51, 93x47 (SOLDER PIN)
CASE 180HH
ISSUE 0

DATE 16 NOV 2021

GENERIC MARKING DIAGRAM*

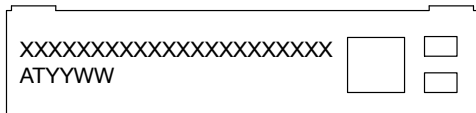

FRONTSIDE MARKING

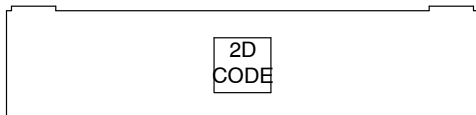

BACKSIDE MARKING

XXXXX = Specific Device Code
AT = Assembly & Test Site Code
YYWW = Year and Work Week Code

*This information is generic. Please refer to device data sheet for actual part marking. Pb-Free indicator, "G" or microdot "▪", may or may not be present. Some products may not follow the Generic Marking.

DOCUMENT NUMBER:	98AON39619H	Electronic versions are uncontrolled except when accessed directly from the Document Repository. Printed versions are uncontrolled except when stamped "CONTROLLED COPY" in red.
DESCRIPTION:	PIM51 93X47 (SOLDER PIN)	PAGE 2 OF 2

onsemi and **ONSEMI** are trademarks of Semiconductor Components Industries, LLC dba **onsemi** or its subsidiaries in the United States and/or other countries. **onsemi** reserves the right to make changes without further notice to any products herein. **onsemi** makes no warranty, representation or guarantee regarding the suitability of its products for any particular purpose, nor does **onsemi** assume any liability arising out of the application or use of any product or circuit, and specifically disclaims any and all liability, including without limitation special, consequential or incidental damages. **onsemi** does not convey any license under its patent rights nor the rights of others.

onsemi, **Onsemi**, and other names, marks, and brands are registered and/or common law trademarks of Semiconductor Components Industries, LLC dba "**onsemi**" or its affiliates and/or subsidiaries in the United States and/or other countries. **onsemi** owns the rights to a number of patents, trademarks, copyrights, trade secrets, and other intellectual property. A listing of **onsemi**'s product/patent coverage may be accessed at www.onsemi.com/site/pdf/Patent-Marking.pdf. **onsemi** reserves the right to make changes at any time to any products or information herein, without notice. The information herein is provided "as-is" and **onsemi** makes no warranty, representation or guarantee regarding the accuracy of the information, product features, availability, functionality, or suitability of its products for any particular purpose, nor does **onsemi** assume any liability arising out of the application or use of any product or circuit, and specifically disclaims any and all liability, including without limitation special, consequential or incidental damages. Buyer is responsible for its products and applications using **onsemi** products, including compliance with all laws, regulations and safety requirements or standards, regardless of any support or applications information provided by **onsemi**. "Typical" parameters which may be provided in **onsemi** data sheets and/or specifications can and do vary in different applications and actual performance may vary over time. All operating parameters, including "Typicals" must be validated for each customer application by customer's technical experts. **onsemi** does not convey any license under any of its intellectual property rights nor the rights of others. **onsemi** products are not designed, intended, or authorized for use as a critical component in life support systems or any FDA Class 3 medical devices or medical devices with a same or similar classification in a foreign jurisdiction or any devices intended for implantation in the human body. Should Buyer purchase or use **onsemi** products for any such unintended or unauthorized application, Buyer shall indemnify and hold **onsemi** and its officers, employees, subsidiaries, affiliates, and distributors harmless against all claims, costs, damages, and expenses, and reasonable attorney fees arising out of, directly or indirectly, any claim of personal injury or death associated with such unintended or unauthorized use, even if such claim alleges that **onsemi** was negligent regarding the design or manufacture of the part. **onsemi** is an Equal Opportunity/Affirmative Action Employer. This literature is subject to all applicable copyright laws and is not for resale in any manner.

ADDITIONAL INFORMATION

TECHNICAL PUBLICATIONS:

Technical Library: www.onsemi.com/design/resources/technical-documentation
onsemi Website: www.onsemi.com

ONLINE SUPPORT: www.onsemi.com/support

For additional information, please contact your local Sales Representative at www.onsemi.com/support/sales