

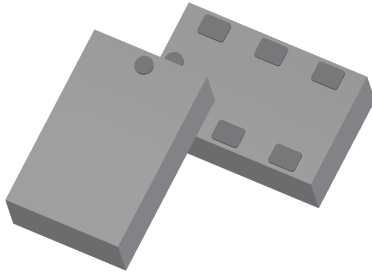

**Ultra Low Profile 0805
3 dB, 90° Hybrid Coupler**



Description:

The C0409J5003AHF is a low cost, low profile sub-miniature high performance 3 dB Hybrid coupler in an easy to use Xinger style surface mount package. It is designed for 400-900 MHz applications including: LTE, 5G and ISM. The C0409J5003AHF is ideal for balanced power signal distribution and other applications where high isolation, low insertion loss and tight amplitude and phase balance are required. The C0409J5003AHF is available on tape and reel for pick and place high volume manufacturing.

All of the Xinger components are constructed from ceramic filled PTFE composites which possess excellent electrical and mechanical stability. All parts have been subjected to rigorous Xinger qualification testing and units are 100% RF tested.

Features:

- 400 – 900 MHz
- 0.72 mm Height Profile
- 5G, LTE & ISM
- High Isolation & Low Loss
- Surface Mountable
- Tape & Reel
- Non-conductive Surface
- RoHS Compliant

Electrical Specifications*:

Parameter (@25°C)	Min.	Typ.	Max	Unit
Frequency	400		900	MHz
Port Impedance		50		Ω
Return Loss	15	20		dB
Isolation	18	24		dB
Insertion Loss		0.6	0.8	dB
Amplitude Balance		1.3	1.8	dB
Phase Balance (relative to 90°)		5	8	Degrees
Power Handling @85°C		4		Watts
Power Handling @105°C		3		Watts
Operating Temperature	-55		+140	°C

* Specifications subject to change without notice.

Outline Drawing:

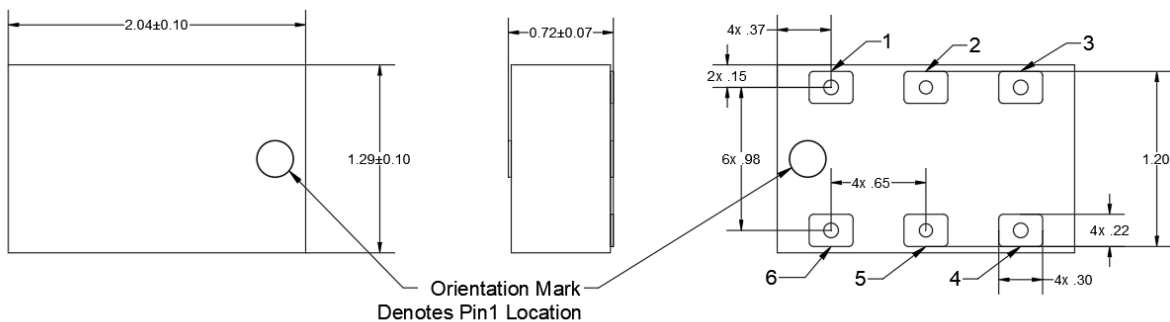

Dimensions are in Millimeters
Tolerance are Non-Cumulative

Pin	Configuration 1	Configuration 2	Configuration 3	Configuration 4
1	Input	Isolated	Direct	Coupled
2	GND	GND	GND	GND
3	Isolated	Input	Coupled	Direct
4	Direct	Coupled	Input	Isolated
5	GND	GND	GND	GND
6	Coupled	Direct	Isolated	Input

Insertion Loss and Power Derating Curves:

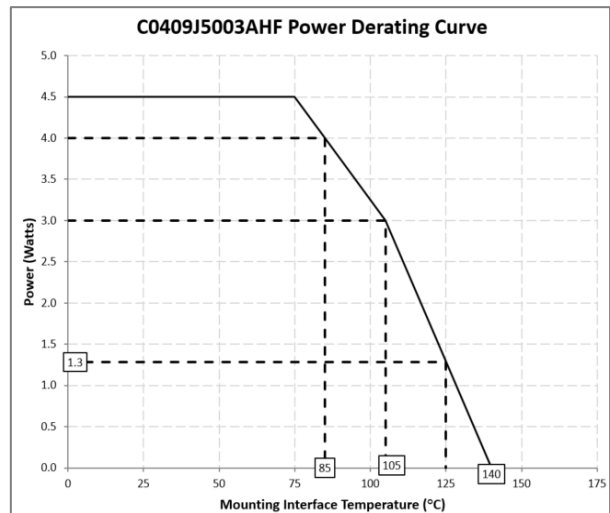
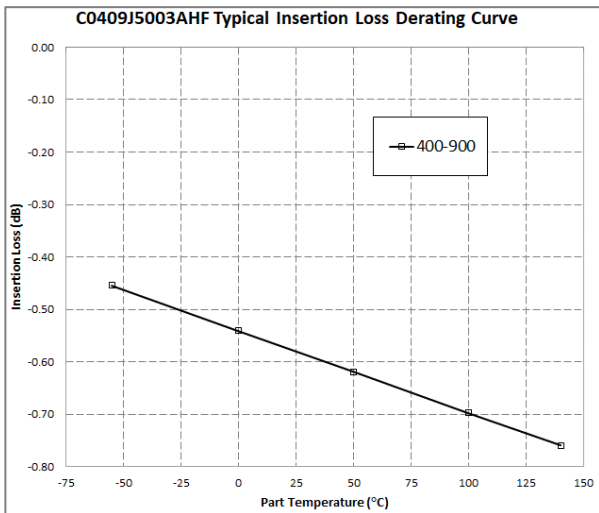

Insertion Loss Derating:

The insertion loss, at a given frequency, of the coupler is measured at 25°C and then averaged. The measurements are performed under small signal conditions (i.e. using a Vector Network Analyzer). The process is repeated at -55°C to 140°C. A best-fit line for the measured data is computed and then plotted from -55°C to 140°C.

Power Derating:

The power handling and corresponding power derating plots are a function of the thermal resistance, mounting surface temperature (base plate temperature), maximum continuous operating temperature of the coupler, and the thermal insertion loss. The thermal insertion loss is defined in the Power Handling section of the data sheet.

As the mounting interface temperature approaches the maximum continuous operating temperature, the power handling decreases to zero.

If mounting temperature is greater than 105°C, coupler will perform reliably as long as the input power is derated to the curve above.

Typical Performance: 300 MHz to 1000 MHz

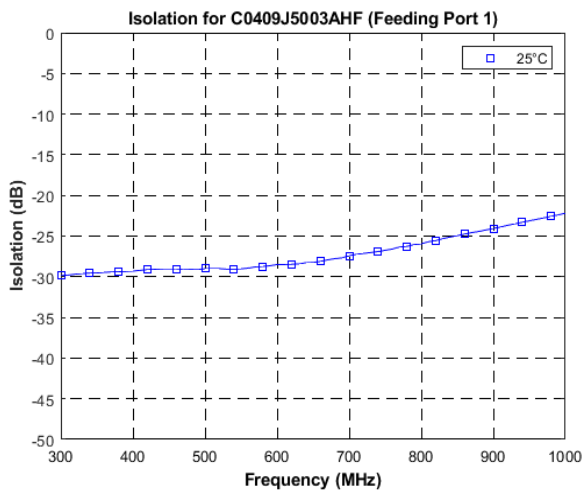
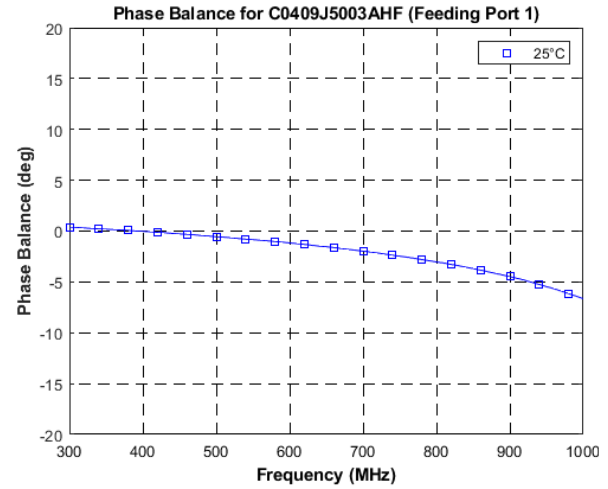
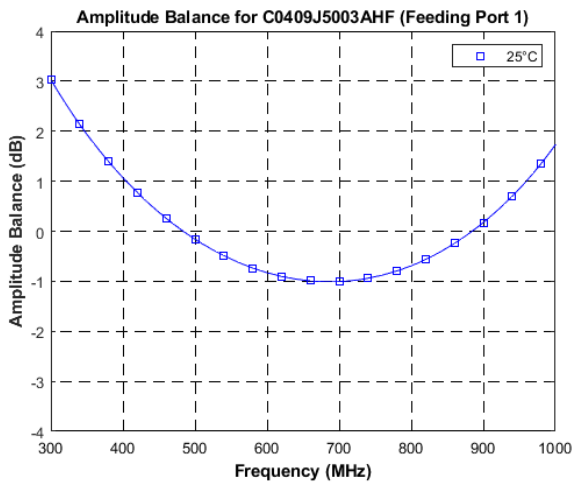
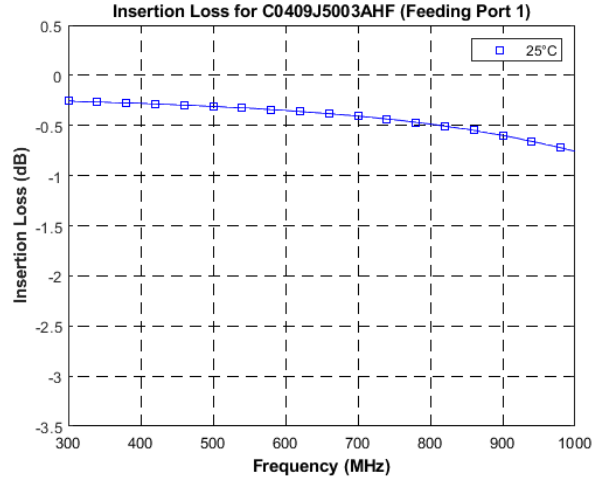
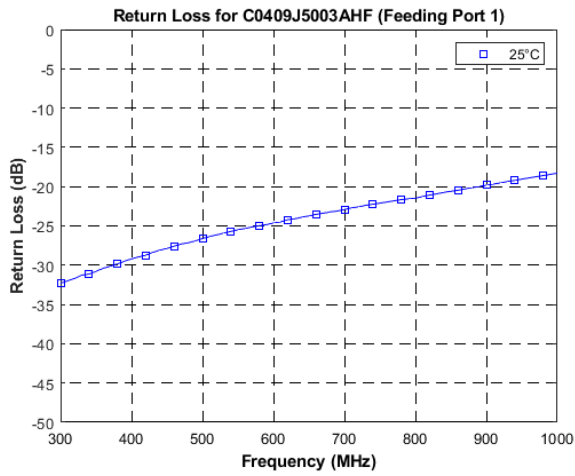

Typical Broadband Performance: 10 MHz to 8010 MHz

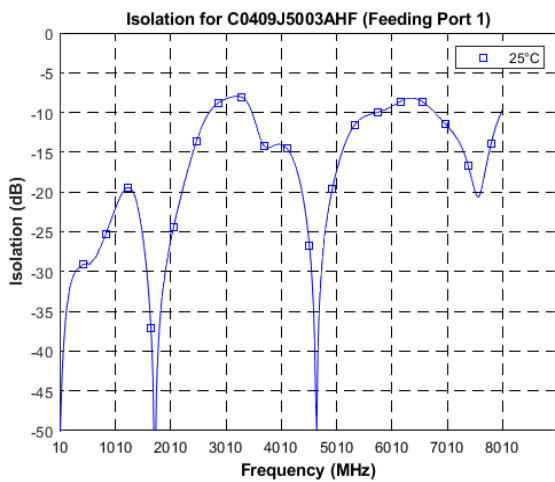
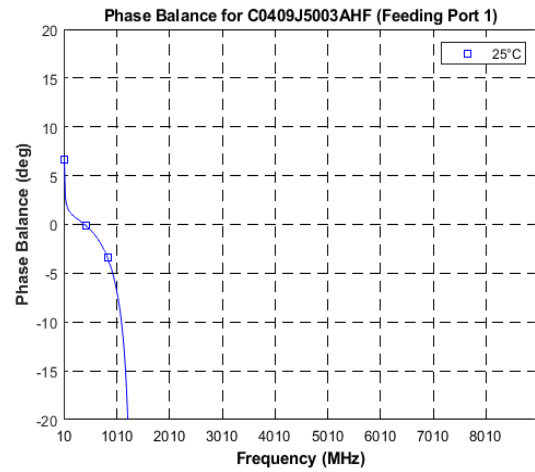
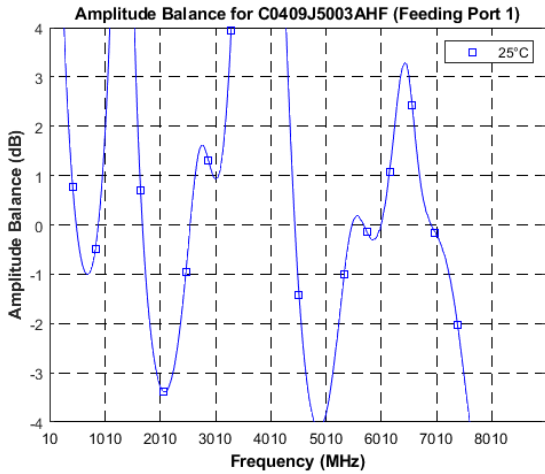
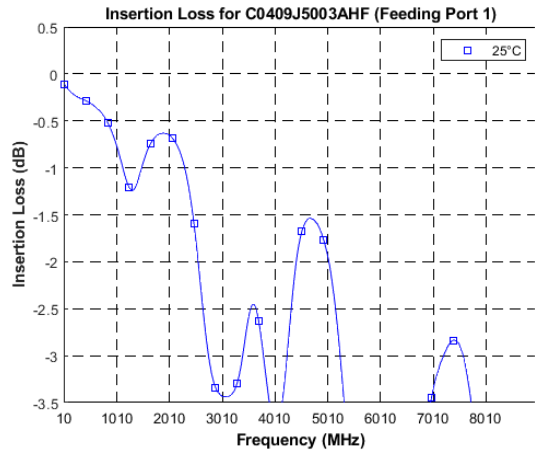
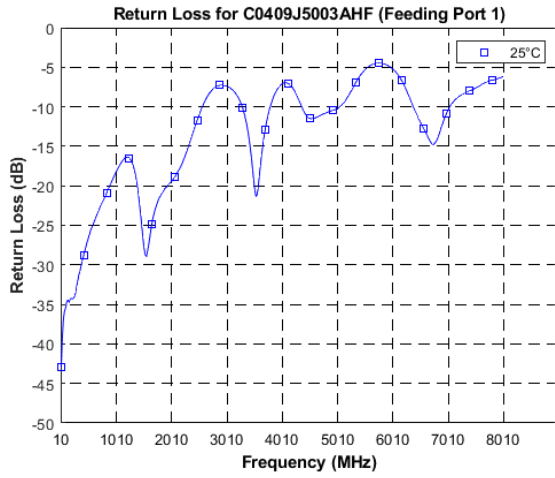

Definition of Measured Specifications:

Parameter	Definition	Mathematical Representation
VSWR (Voltage Standing Wave Ratio)	The impedance match of the coupler to a 50Ω system. A VSWR of 1:1 is optimal.	$VSWR = \frac{V_{max}}{V_{min}}$ Vmax = voltage maxima of a standing wave Vmin = voltage minima of a standing wave
Return Loss	The impedance match of the coupler to a 50Ω system. Return Loss is an alternate means to express VSWR.	$Return\ Loss(dB) = 20\log \frac{VSWR + 1}{VSWR - 1}$
Insertion Loss	The input power divided by the sum of the power at the two output ports.	$Insertion\ Loss(dB) = 10\log \frac{P_{in}}{P_{cpl} + P_{direct}}$
Isolation	The input power divided by the power at the isolated port.	$Isolation(dB) = 10\log \frac{P_{in}}{P_{iso}}$
Amplitude Balance	The power at each output divided by the average power of the two outputs.	$10\log \frac{P_{cpl}}{(P_{cpl} + P_{direct})/2}$ and $10\log \frac{P_{direct}}{(P_{cpl} + P_{direct})/2}$
Phase Balance	The difference in phase angle between the two output ports.	<i>Phase at coupled port – Phase at direct port</i>
Group Delay (GD-C)	Group delay is average of group delay's from input port to the coupled port	<i>Average (GD – C)</i>
Group Delay (GD-DC)	Group delay is average of group delay's from input port to the direct port	<i>Average (GD – DC)</i>

*100% RF test is performed per spec definition for pin configuration 1 (refer to page 1 for pin configuration).

Peak Power Handling:

High-Pot testing of these components during the qualification procedure resulted in a minimum breakdown voltage of 1Kv (minimum recorded value). This voltage level corresponds to a breakdown resistance capable of handling at least 12dB peak over average power levels, for very short durations. The breakdown location consistently occurred across the pads and the ground pads (see illustration below). The breakdown levels at these points will be affected by any contamination in the gap area around these pads. These areas must be kept clean for optimum performance. It is recommended that the user test for voltage breakdown under the maximum operating conditions and over worst case modulation induced power peaking. This evaluation should also include extreme environmental conditions (such as high humidity).

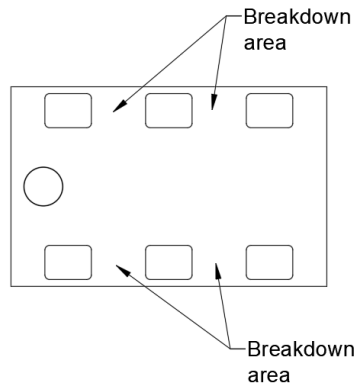

Packaging and Ordering Information:

Parts are available in reel and are packaged per EIA 481. Parts are oriented in tape and reel as shown below. Minimum order quantities are 4000 per reel.

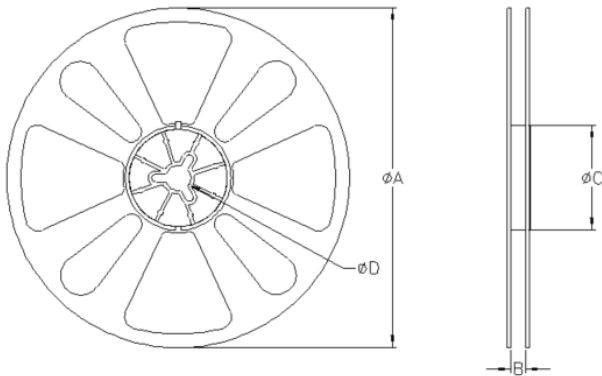
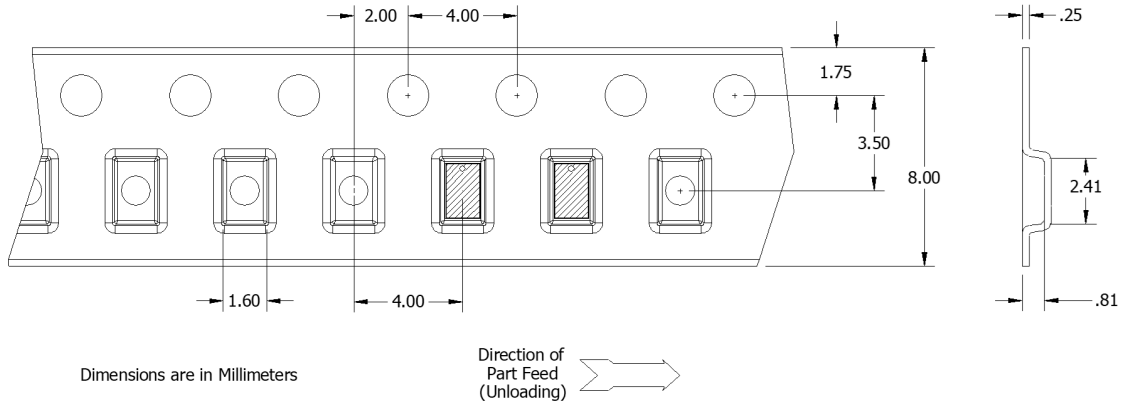

TABLE 1		
QUANTITY/REEL	REEL DIMENSIONS mm	
4000	φA	177.80
	B	8.00
	φC	50.80
	φD	13.00

Contact us:
rf&s_support@ttm.com