

DATA SHEET

# DME, DMF, DMJ Series: Silicon Beam-Lead Schottky Mixer Diode (Singles, Pairs, and Quads) Bondable Beam-Lead Devices

## Applications

- Microwave Integrated Circuits
- Mixers
- Detectors

## Features

- Low 1/f noise
- Low intermodulation distortion
- Statistical Process Control wafer fabrication



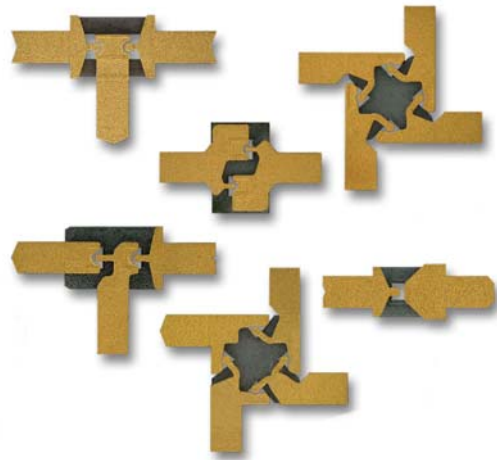
Skyworks Green™ products are compliant with all applicable legislation and are halogen-free. For additional information, refer to *Skyworks Definition of Green™*, document number SQ04-0074.

## Description

Skyworks beam-lead silicon Schottky barrier mixer diodes are designed for applications through 40 GHz. The beam-lead design reduces the problem of bonding to the very small area characteristic of low capacitance junctions.

Beam-lead Schottky barrier mixer diodes are made by the deposition of a suitable barrier metal on an epitaxial silicon substrate to form the junction. The process and choice of materials result in low series resistance with a narrow spread of capacitance values for close impedance control.

A variety of forward voltages are available ranging from low values for low, or starved, local oscillator drive levels to high values for high drive, low distortion mixer applications. Capacitance ranges and series resistances are comparable with the beam-lead devices that are available up to, and including, the Ka-band. These diodes are well suited for use in Microwave Integrated Circuits (MICs).



Beam-lead Schottky barrier diodes are categorized by universal mixer applications in six frequency ranges: S, C, X, Ku, K, and Ka bands as noted in Table 1. They can also be used as modulators and high-speed switches.

Beam-lead diodes are suited for balanced mixers, due to their low parasitics and uniformity.

**Table 1. Frequency Table**

| Frequency Band | Frequency (GHz) |
|----------------|-----------------|
| S              | 2 to 4          |
| C              | 4 to 8          |
| X              | 8.2 to 12.4     |
| Ku             | 12.4 to 18.0    |
| K              | 18.0 to 26.5    |
| Ka             | 26.5 to 40.0    |

**Electrical and Mechanical Specifications**

The absolute maximum ratings of the DME, DMF, and DMJ series of Schottky mixer diodes are provided in Table 2. Electrical and physical specifications are provided in Tables 3 through 8.

Typical performance characteristics are shown in Figures 1 through 3. Typical mixer circuits are shown in Figure 4.

**Table 2. Absolute Maximum Ratings (Note 1)**

| Parameter                           | Symbol           | Minimum | Typical | Maximum | Units       |
|-------------------------------------|------------------|---------|---------|---------|-------------|
| Maximum current                     | I <sub>max</sub> |         |         | 100     | mA          |
| Power dissipation (continuous wave) | P <sub>d</sub>   |         |         | 75      | mW/junction |
| Storage temperature                 | T <sub>STG</sub> | -65     |         | +175    | °C          |
| Operating temperature               | T <sub>A</sub>   | -65     |         | +175    | °C          |

**Note 1:** Exposure to maximum rating conditions for extended periods may reduce device reliability. There is no damage to device with only one parameter set at the limit and all other parameters set at or below their nominal value. Exceeding any of the limits listed here may result in permanent damage to the device.

**CAUTION:** Although these devices are designed to be as robust as possible, electrostatic discharge (ESD) can damage them. These devices must be protected at all times from ESD. Static charges may easily produce potentials of several kilovolts on the human body or equipment, which can discharge without detection. Industry-standard ESD precautions should be used at all times.

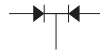
**Table 3. Electrical Specifications: Beam-Lead Single N-Type Low, Medium, High Drive Schottky Diodes**



| Part Number | Frequency Band | C <sub>J</sub> @ 0 V, 1 MHz (pF) | Rs @ 5 mA (Ω) | V <sub>B</sub> @ 10 μA (V) | V <sub>F</sub> @ 1 mA (mV) | Drive Level | Outline Drawing |
|-------------|----------------|----------------------------------|---------------|----------------------------|----------------------------|-------------|-----------------|
|             |                |                                  | Max.          | Min.                       |                            |             |                 |
| DMF2820-000 | S, C           | 0.30 to 0.50                     | 5             | 2                          | 200 to 260                 | low         | 491-011         |
| DME2127-000 | S, C           | 0.30 to 0.50                     | 5             | 3                          | 300 to 400                 | medium      | 491-011         |
| DMJ2823-000 | S, C           | 0.30 to 0.50                     | 5             | 4                          | 500 to 600                 | high        | 491-011         |
| DMF2821-000 | X              | 0.15 to 0.30                     | 8             | 2                          | 220 to 300                 | low         | 491-011         |
| DME2957-000 | X              | 0.15 to 0.30                     | 8             | 3                          | 325 to 425                 | medium      | 491-011         |
| DMJ2777-000 | X              | 0.15 to 0.30                     | 8             | 4                          | 550 to 650                 | high        | 491-011         |
| DMF2344-000 | Ku             | 0.05 to 0.15                     | 13            | 2                          | 260 to 330                 | low         | 491-011         |
| DME2333-000 | Ku             | 0.05 to 0.15                     | 13            | 3                          | 350 to 450                 | medium      | 491-011         |
| DMJ2824-000 | Ku             | 0.05 to 0.15                     | 13            | 4                          | 500 to 680                 | high        | 491-011         |
| DMF2822-000 | K, Ka          | 0.1 max                          | 18            | 2                          | 270 to 350                 | low         | 491-011         |
| DME2458-000 | K, Ka          | 0.1 max                          | 18            | 3                          | 375 to 550                 | medium      | 491-011         |
| DMJ2825-000 | K, Ka          | 0.1 max                          | 18            | 4                          | 600 to 700                 | high        | 491-011         |

**Table 4. Electrical Specifications: Beam-Lead Series Pair, N-Type Low, Medium, High Drive Schottky Diodes**

| Part Number | Frequency Band | C <sub>J</sub> @ 0 V, 1 MHz (pF) | Rs @ 5 mA (Ω) | V <sub>B</sub> @ 10 μA (V) | V <sub>F</sub> @ 1 mA (mV) | Drive Level | Outline Drawing |
|-------------|----------------|----------------------------------|---------------|----------------------------|----------------------------|-------------|-----------------|
|             |                |                                  | Max.          | Min.                       |                            |             |                 |
| DMF2835-000 | S, C           | 0.30 to 0.50                     | 5             | 2                          | 200 to 260                 | low         | 504-012         |
| DME2050-000 | S, C           | 0.30 to 0.50                     | 5             | 3                          | 300 to 400                 | medium      | 504-012         |
| DMJ2092-000 | S, C           | 0.30 to 0.50                     | 5             | 4                          | 500 to 600                 | high        | 504-012         |
| DMF2826-000 | X              | 0.15 to 0.30                     | 8             | 2                          | 220 to 300                 | low         | 504-012         |
| DME2829-000 | X              | 0.15 to 0.30                     | 8             | 3                          | 325 to 425                 | medium      | 504-012         |
| DMJ2093-000 | X              | 0.15 to 0.30                     | 8             | 4                          | 550 to 650                 | high        | 504-012         |
| DMF2827-000 | Ku             | 0.05 to 0.15                     | 13            | 2                          | 260 to 330                 | low         | 504-012         |
| DME2830-000 | Ku             | 0.05 to 0.15                     | 13            | 3                          | 350 to 450                 | medium      | 504-012         |
| DMJ2832-000 | Ku             | 0.05 to 0.15                     | 13            | 4                          | 500 to 680                 | high        | 504-012         |
| DMF2828-000 | K, Ka          | 0.1 max                          | 18            | 2                          | 270 to 350                 | low         | 504-012         |
| DME2831-000 | K, Ka          | 0.1 max                          | 18            | 3                          | 375 to 550                 | medium      | 504-012         |
| DMJ2833-000 | K, Ka          | 0.1 max                          | 18            | 4                          | 600 to 700                 | high        | 504-012         |

**Table 5. Electrical Specifications: Beam-Lead Common Cathode, N-Type Low, Medium, High Drive Schottky Diodes**

| Part Number | Frequency Band | C <sub>J</sub> @ 0 V, 1 MHz (pF) | Rs @ 5 mA (Ω) | V <sub>B</sub> @ 10 μA (V) | V <sub>F</sub> @ 1 mA (mV) | Drive Level | Outline Drawing |
|-------------|----------------|----------------------------------|---------------|----------------------------|----------------------------|-------------|-----------------|
|             |                |                                  | Max.          | Min.                       |                            |             |                 |
| DMF2182-000 | S, C           | 0.30 to 0.50                     | 5             | 2                          | 200 to 260                 | low         | 504-013         |
| DME2205-000 | S, C           | 0.30 to 0.50                     | 5             | 3                          | 300 to 400                 | medium      | 504-013         |
| DMJ2208-000 | S, C           | 0.30 to 0.50                     | 5             | 4                          | 500 to 600                 | high        | 504-013         |
| DMF2183-000 | X              | 0.15 to 0.30                     | 8             | 2                          | 220 to 300                 | low         | 504-013         |
| DME2206-000 | X              | 0.15 to 0.30                     | 8             | 3                          | 325 to 425                 | medium      | 504-013         |
| DMJ2209-000 | X              | 0.15 to 0.30                     | 8             | 4                          | 550 to 650                 | high        | 504-013         |
| DMF2184-000 | Ku             | 0.05 to 0.15                     | 13            | 2                          | 260 to 330                 | low         | 504-013         |
| DME2207-000 | Ku             | 0.05 to 0.15                     | 13            | 3                          | 350 to 450                 | medium      | 504-013         |
| DMJ2210-000 | Ku             | 0.05 to 0.15                     | 13            | 4                          | 500 to 680                 | high        | 504-013         |
| DMF2834-000 | K, Ka          | 0.1 max                          | 18            | 2                          | 270 to 350                 | low         | 504-013         |
| DME2864-000 | K, Ka          | 0.1 max                          | 18            | 3                          | 375 to 550                 | medium      | 504-013         |
| DMJ2836-000 | K, Ka          | 0.1 max                          | 18            | 4                          | 600 to 700                 | high        | 504-013         |

**Table 6. Electrical Specifications: Beam-Lead Anti-Parallel, N-Type Low, Medium, High Drive Schottky Diodes**



| Part Number | Frequency Band | C <sub>J</sub> @ 0 V, 1 MHz (pF) | Rs @ 5 mA (Ω) | V <sub>B</sub> @ 10 μA (V) | V <sub>F</sub> @ 1 mA (mV) | Drive Level | Outline Drawing |
|-------------|----------------|----------------------------------|---------------|----------------------------|----------------------------|-------------|-----------------|
|             |                |                                  | Max.          | Min.                       |                            |             |                 |
| DMF2185-000 | S, C           | 0.30 to 0.50                     | 5             | 2                          | 200 to 260                 | low         | 522-025         |
| DME2282-000 | S, C           | 0.30 to 0.50                     | 5             | 3                          | 300 to 400                 | medium      | 522-025         |
| DMJ2303-000 | S, C           | 0.30 to 0.50                     | 5             | 4                          | 500 to 600                 | high        | 522-025         |
| DMF2186-000 | X              | 0.15 to 0.30                     | 8             | 2                          | 220 to 300                 | low         | 522-025         |
| DME2283-000 | X              | 0.15 to 0.30                     | 8             | 3                          | 325 to 425                 | medium      | 522-025         |
| DMJ2304-000 | X              | 0.15 to 0.30                     | 8             | 4                          | 550 to 650                 | high        | 522-025         |
| DMF2187-000 | Ku             | 0.05 to 0.15                     | 13            | 2                          | 260 to 330                 | low         | 522-025         |
| DME2284-000 | Ku             | 0.05 to 0.15                     | 13            | 3                          | 350 to 450                 | medium      | 522-025         |
| DMJ2246-000 | Ku             | 0.05 to 0.15                     | 13            | 4                          | 500 to 680                 | high        | 522-025         |
| DMF2837-000 | K, Ka          | 0.1 max                          | 18            | 2                          | 270 to 350                 | low         | 522-025         |
| DME2838-000 | K, Ka          | 0.1 max                          | 18            | 3                          | 375 to 550                 | medium      | 522-025         |
| DMJ2839-000 | K, Ka          | 0.1 max                          | 18            | 4                          | 600 to 700                 | high        | 522-025         |

**Table 7. Electrical Specifications: Beam-Lead Ring Quad, N-Type Low, Medium, High Drive Schottky Diodes**



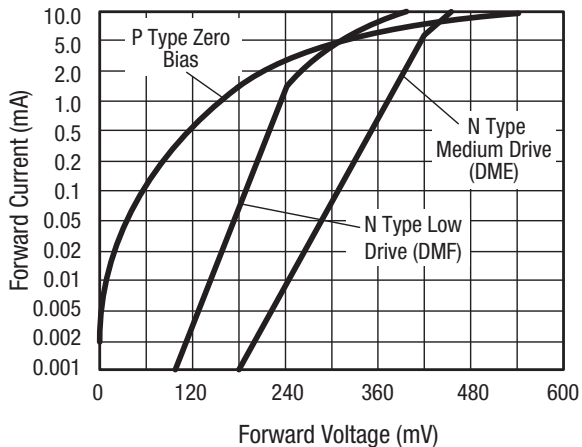
| Part Number | Frequency Band | C <sub>J</sub> @ 0 V, 1 MHz (pF) | Rs @ 5 mA (Ω) | V <sub>B</sub> @ 10 μA (V) | V <sub>F</sub> @ 1 mA (mV) | Drive Level | Outline Drawing |
|-------------|----------------|----------------------------------|---------------|----------------------------|----------------------------|-------------|-----------------|
|             |                |                                  | Max.          | Min.                       |                            |             |                 |
| DMF2865-000 | S, C           | 0.30 to 0.50                     | 5             | 2                          | 200 to 260                 | low         | 488-002         |
| DME2857-000 | S, C           | 0.30 to 0.50                     | 5             | 3                          | 300 to 400                 | medium      | 488-002         |
| DMJ2502-000 | S, C           | 0.30 to 0.50                     | 5             | 4                          | 500 to 600                 | high        | 488-002         |
| DMF2011-000 | X              | 0.15 to 0.30                     | 8             | 2                          | 220 to 300                 | low         | 488-002         |
| DME2858-000 | X              | 0.15 to 0.30                     | 8             | 3                          | 325 to 425                 | medium      | 488-002         |
| DMJ2990-000 | X              | 0.15 to 0.30                     | 8             | 4                          | 550 to 650                 | high        | 488-002         |
| DMF2012-000 | Ku             | 0.05 to 0.15                     | 13            | 2                          | 260 to 330                 | low         | 488-002         |
| DME2859-000 | Ku             | 0.05 to 0.15                     | 13            | 3                          | 350 to 450                 | medium      | 488-002         |
| DMJ2667-000 | Ku             | 0.05 to 0.15                     | 13            | 4                          | 500 to 680                 | high        | 488-002         |
| DMF2454-000 | K, Ka          | 0.1 max                          | 18            | 2                          | 270 to 350                 | low         | 488-002         |
| DME2459-000 | K, Ka          | 0.1 max                          | 18            | 3                          | 375 to 550                 | medium      | 488-002         |
| DMJ2455-000 | K, Ka          | 0.1 max                          | 18            | 4                          | 600 to 700                 | high        | 488-002         |

**Table 8. Electrical Specifications: Beam-Lead Bridge Quad, N-Type Low, Medium, High Drive Schottky Diodes**

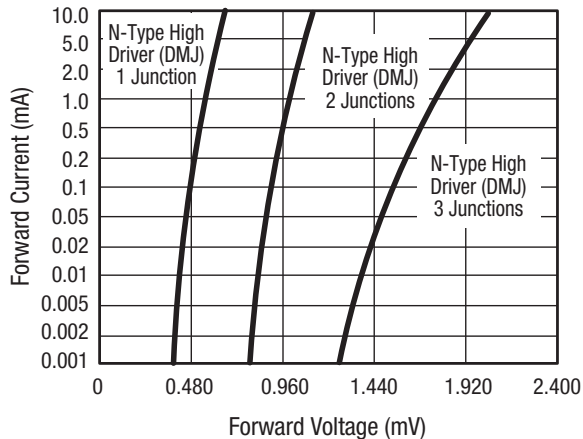


| Part Number | Frequency Band | C <sub>J</sub> @ 0 V, 1 MHz (pF) | Rs @ 5 mA (Ω) | V <sub>B</sub> @ 10 μA (V) | V <sub>F</sub> @ 1 mA (mV) | Drive Level | Outline Drawing |
|-------------|----------------|----------------------------------|---------------|----------------------------|----------------------------|-------------|-----------------|
|             |                |                                  | Max.          | Min.                       |                            |             |                 |
| DMF2076-000 | S, C           | 0.30 to 0.50                     | 5             | 2                          | 200 to 260                 | low         | 488-004         |
| DME2029-000 | S, C           | 0.30 to 0.50                     | 5             | 3                          | 300 to 400                 | medium      | 488-004         |
| DMJ2312-000 | S, C           | 0.30 to 0.50                     | 5             | 4                          | 500 to 600                 | high        | 488-004         |
| DMF2077-000 | X              | 0.15 to 0.30                     | 8             | 2                          | 220 to 300                 | low         | 488-004         |
| DME2850-000 | X              | 0.15 to 0.30                     | 8             | 3                          | 325 to 425                 | medium      | 488-004         |
| DMJ2088-000 | X              | 0.15 to 0.30                     | 8             | 4                          | 550 to 650                 | high        | 488-004         |
| DMF2078-000 | Ku             | 0.05 to 0.15                     | 13            | 2                          | 260 to 330                 | low         | 488-004         |
| DME2031-000 | Ku             | 0.05 to 0.15                     | 13            | 3                          | 350 to 450                 | medium      | 488-004         |
| DMJ2768-000 | Ku             | 0.05 to 0.15                     | 13            | 4                          | 500 to 680                 | high        | 488-004         |
| DMF2848-000 | K, Ka          | 0.1 max                          | 18            | 2                          | 270 to 350                 | low         | 488-004         |
| DME2851-000 | K, Ka          | 0.1 max                          | 18            | 3                          | 375 to 550                 | medium      | 488-004         |
| DMJ2852-000 | K, Ka          | 0.1 max                          | 18            | 4                          | 600 to 700                 | high        | 488-004         |

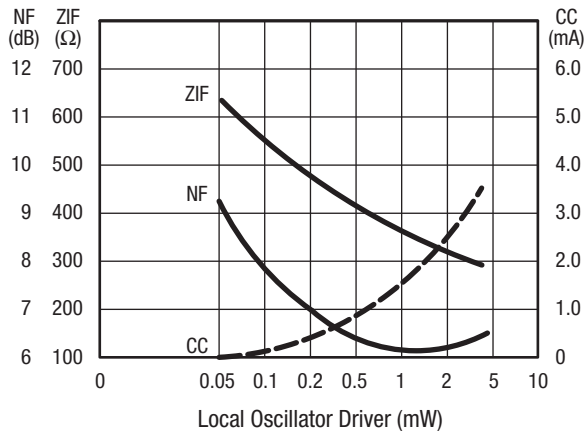
### Typical Performance Characteristics



**Figure 1. Typical Forward DC Characteristic Curves (Voltage vs Current)**

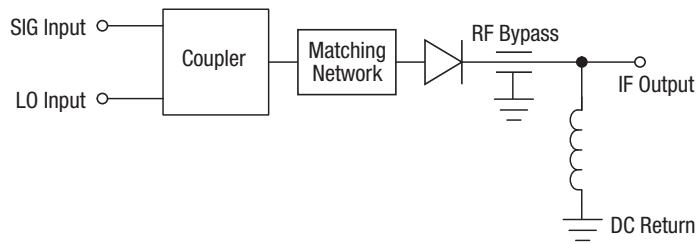


**Figure 2. Typical Forward DC Characteristic Curves (Voltage vs current)**

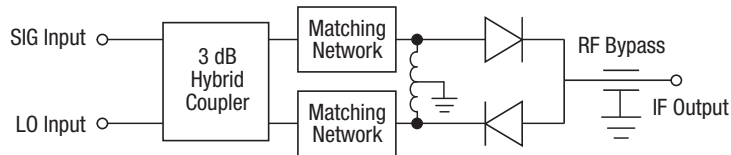


**Figure 3. Typical X-Band Low Drive Mixer Diode RF Parameters vs Local Oscillator Drive**

Single Ended Mixer



Balanced Mixer



Double Balanced Mixer

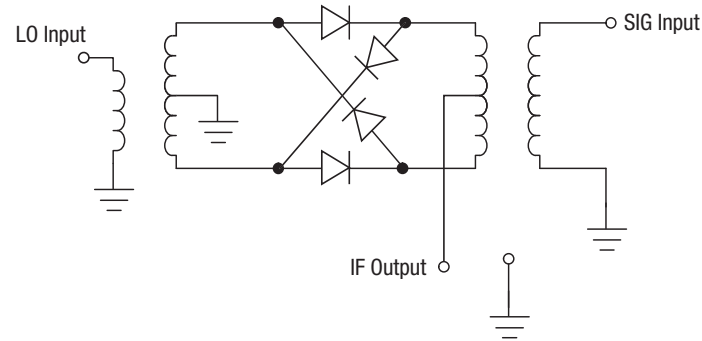


Figure 4. Typical Mixer Circuits

Dimensions and Package Information

Additional bonding and handling methods are contained in the Skyworks Application Note, *Diode Chips, Beam-Lead Diodes, Capacitors: Bonding Methods and Packaging* (document #200532).

Dimensions are provided in Figures 5 through 10.

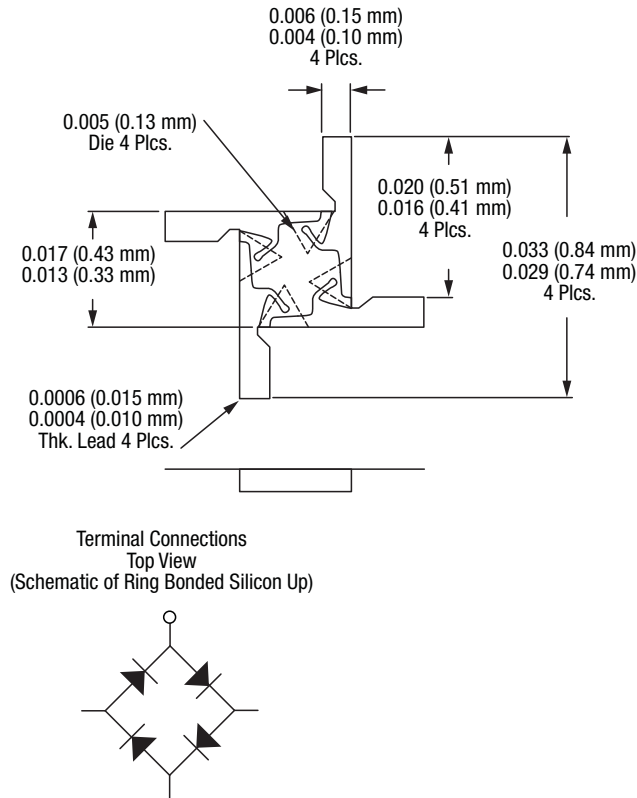


Figure 5. 488-002 Package Dimensions

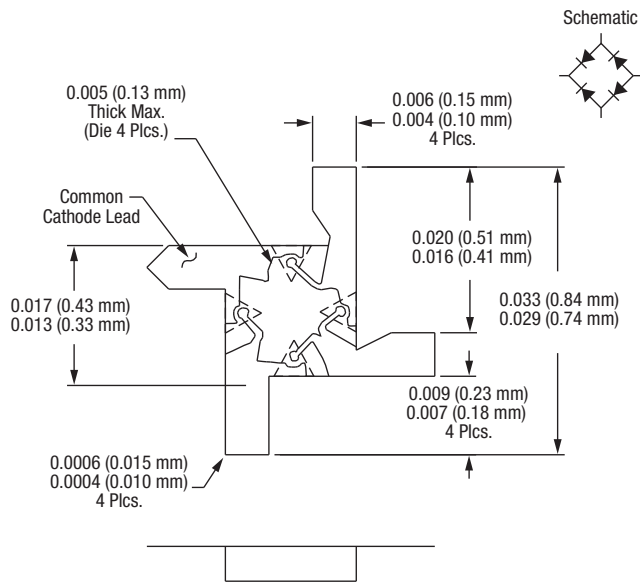


Figure 6. 488-004 Package Dimensions



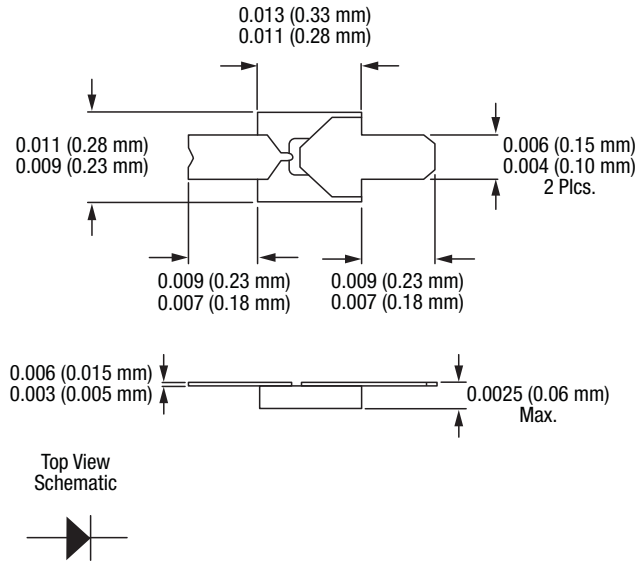


Figure 7. 491-011 Package Dimensions

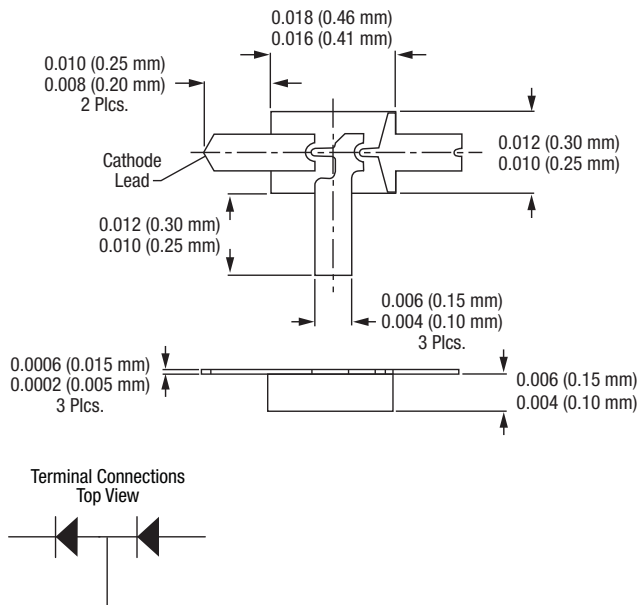


Figure 8. 504-012 Package Dimensions

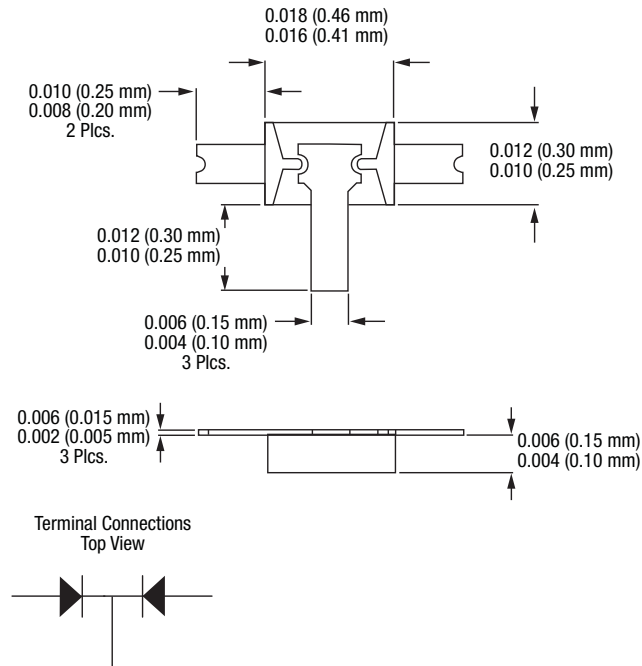


Figure 9. 504-013 Package Dimensions

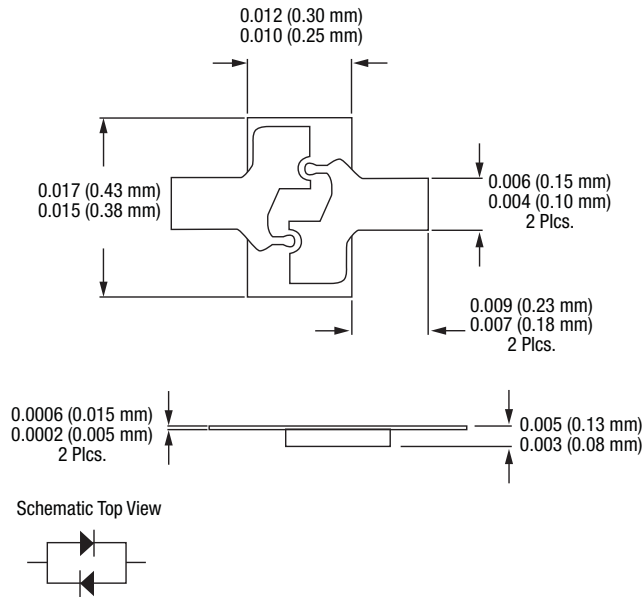


Figure 10. 522-025 Package Dimensions

Copyright © 2002-2009, 2014 Skyworks Solutions, Inc. All Rights Reserved.

Information in this document is provided in connection with Skyworks Solutions, Inc. ("Skyworks") products or services. These materials, including the information contained herein, are provided by Skyworks as a service to its customers and may be used for informational purposes only by the customer. Skyworks assumes no responsibility for errors or omissions in these materials or the information contained herein. Skyworks may change its documentation, products, services, specifications or product descriptions at any time, without notice. Skyworks makes no commitment to update the materials or information and shall have no responsibility whatsoever for conflicts, incompatibilities, or other difficulties arising from any future changes.

No license, whether express, implied, by estoppel or otherwise, is granted to any intellectual property rights by this document. Skyworks assumes no liability for any materials, products or information provided hereunder, including the sale, distribution, reproduction or use of Skyworks products, information or materials, except as may be provided in Skyworks Terms and Conditions of Sale.

THE MATERIALS, PRODUCTS AND INFORMATION ARE PROVIDED "AS IS" WITHOUT WARRANTY OF ANY KIND, WHETHER EXPRESS, IMPLIED, STATUTORY, OR OTHERWISE, INCLUDING FITNESS FOR A PARTICULAR PURPOSE OR USE, MERCHANTABILITY, PERFORMANCE, QUALITY OR NON-INFRINGEMENT OF ANY INTELLECTUAL PROPERTY RIGHT; ALL SUCH WARRANTIES ARE HEREBY EXPRESSLY DISCLAIMED. SKYWORKS DOES NOT WARRANT THE ACCURACY OR COMPLETENESS OF THE INFORMATION, TEXT, GRAPHICS OR OTHER ITEMS CONTAINED WITHIN THESE MATERIALS. SKYWORKS SHALL NOT BE LIABLE FOR ANY DAMAGES, INCLUDING BUT NOT LIMITED TO ANY SPECIAL, INDIRECT, INCIDENTAL, STATUTORY, OR CONSEQUENTIAL DAMAGES, INCLUDING WITHOUT LIMITATION, LOST REVENUES OR LOST PROFITS THAT MAY RESULT FROM THE USE OF THE MATERIALS OR INFORMATION, WHETHER OR NOT THE RECIPIENT OF MATERIALS HAS BEEN ADVISED OF THE POSSIBILITY OF SUCH DAMAGE.

Skyworks products are not intended for use in medical, lifesaving or life-sustaining applications, or other equipment in which the failure of the Skyworks products could lead to personal injury, death, physical or environmental damage. Skyworks customers using or selling Skyworks products for use in such applications do so at their own risk and agree to fully indemnify Skyworks for any damages resulting from such improper use or sale.

Customers are responsible for their products and applications using Skyworks products, which may deviate from published specifications as a result of design defects, errors, or operation of products outside of published parameters or design specifications. Customers should include design and operating safeguards to minimize these and other risks. Skyworks assumes no liability for applications assistance, customer product design, or damage to any equipment resulting from the use of Skyworks products outside of stated published specifications or parameters.

Skyworks and the Skyworks symbol are trademarks or registered trademarks of Skyworks Solutions, Inc., in the United States and other countries. Third-party brands and names are for identification purposes only, and are the property of their respective owners. Additional information, including relevant terms and conditions, posted at [www.skyworksinc.com](http://www.skyworksinc.com), are incorporated by reference.

# Mouser Electronics

Authorized Distributor

Click to View Pricing, Inventory, Delivery & Lifecycle Information:

## Skyworks:

[DME2206-000](#) [DME2282-000](#) [DME2333-000](#) [DME2838-000](#) [DME2851-000](#) [DME2857-000](#) [DME2859-000](#)  
[DME2957-000](#) [DMF2011-000](#) [DMF2076-000](#) [DMF2077-000](#) [DMF2183-000](#) [DMF2821-000](#) [DMF2826-000](#)  
[DMF2835-000](#) [DMF2865-000](#) [DMJ2088-000](#) [DMJ2092-000](#) [DMJ2209-000](#) [DMJ2210-000](#) [DMJ2246-000](#) [DMJ2303-](#)  
[000](#) [DMJ2304-000](#) [DMJ2312-000](#) [DMJ2502-000](#) [DMJ2768-000](#) [DMJ2777-000](#) [DMJ2824-000](#) [DMJ2832-000](#)  
[DMJ2836-000](#) [DMJ2839-000](#) [DMJ2990-000](#) [DME2029-000](#) [DME2031-000](#) [DME2205-000](#) [DME2207-000](#)  
[DME2283-000](#) [DME2284-000](#) [DME2831-000](#) [DME2850-000](#) [DME2858-000](#) [DME2864-000](#) [DMF2012-000](#)  
[DMF2078-000](#) [DMF2182-000](#) [DMF2184-000](#) [DMF2185-000](#) [DMF2186-000](#) [DMF2187-000](#) [DMF2834-000](#)  
[DMJ2208-000](#) [DMJ2667-000](#)