

Data sheet | Item number: 2042-3819

Relay module; 230 VAC/VDC; Relay with 2 make contacts (2a)

[www.wago.com/2042-3819](http://www.wago.com/2042-3819)

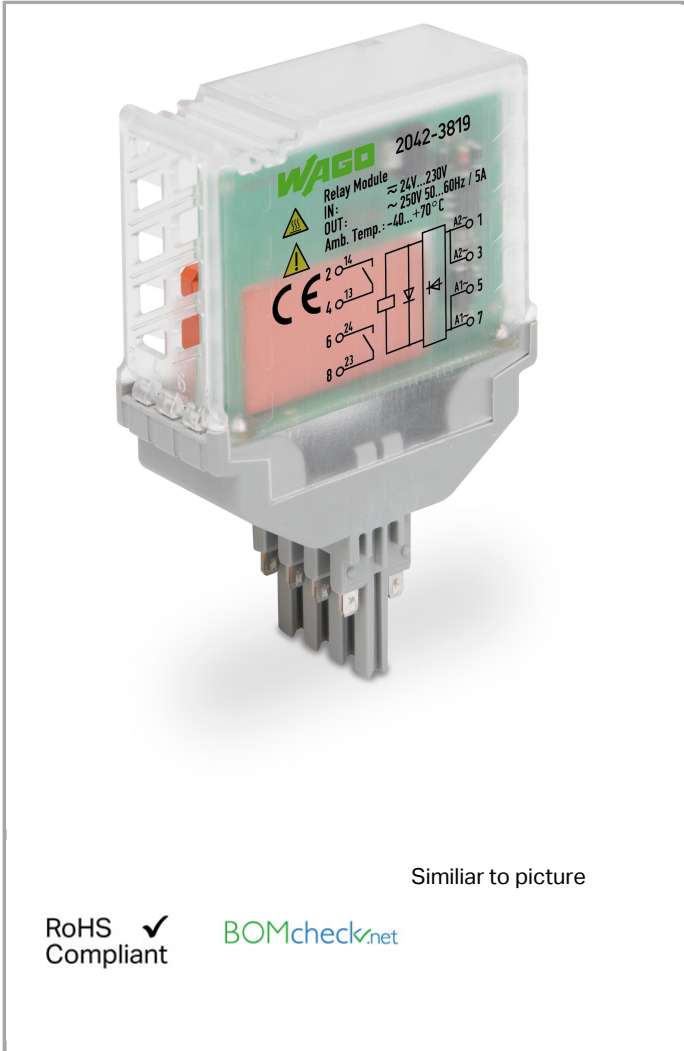

Similar to picture

RoHS  
Compliant ✓

[BOMcheck.net](https://www.bomcheck.net)

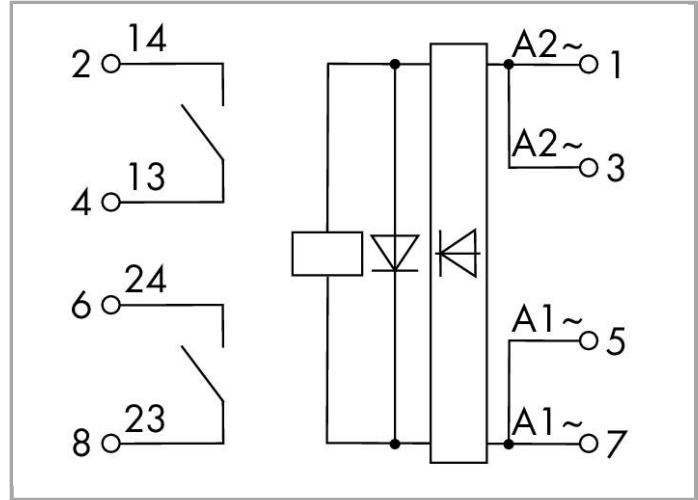

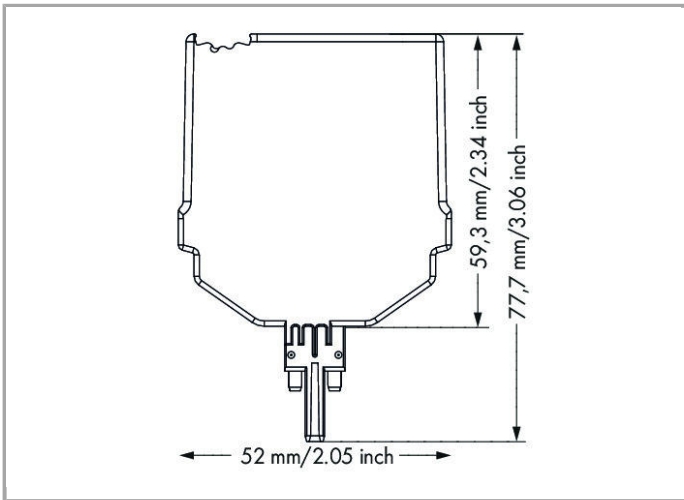

## Data

### Technical Data

### Control circuit

Nominal input voltage $U_N$	24 ... 230 V AC/DC
Input voltage range	$\pm 10\%$
Nominal input current at $U_N$	2.9 mA (at 230 V); 49.1 mA (at 24 V)

### Load circuit:

Number of make contacts/switch on contacts	2
Contact material (relay)	AgNi
Limiting continuous current	5 A
Max. make current (resistive)	15 A (AC)
Max. switching voltage	250 VAC
Max. switching power (resistive)	1250 VAAC; DC see load limit curve
Recommended minimum load	5 V / 100 mA
Pull-in time (typ.)	8 ms
Drop-out time (typ.)	6 ms
Bounce time (typ.)	4 ms
Electrical life (N.O.; resistive load; 23 °C)	$100 \times 10^3$ switching operations (2 x 8 A)
Mechanical life (N.O.; resistive load; 23 °C)	$10 \times 10^6$ switching operations

### Signaling

Status indication	LED green
-------------------	-----------

### Safety and protection:

Rated voltage	250 V
Rated impulse voltage	4 kV
Pollution degree	2
Dielectric strength, control/load circuit (AC, 1 min)	3 kV <sub>rms</sub>
Dielectric strength, control/load circuit (AC, 1 min)	3 kV <sub>rms</sub>
Dielectric strength open contact (AC, 1 min)	1 kV <sub>rms</sub>
Dielectric strength open contact (AC, 1 min)	1 kV <sub>rms</sub>
Dielectric strength, channel/channel (AC, 1 min)	2.5 kV <sub>rms</sub>
Dielectric strength, channel/channel (AC, 1 min)	2.5 kV <sub>rms</sub>
Degree of protection	IP20

### Geometrical Data

Width	20.7 mm / 0.815 inch
Height	77.7 mm / 3.059 inch
Height from the surface	59.3 mm / 2.335 inch
Depth	52 mm / 2.047 inch

### Mechanical data

Type of mounting	Pluggable module for TOPJOB® S carrier terminal block
------------------	---

### Material Data

Flammability class per UL94	V0
Weight	40.1 g

### Environmental Requirements

Surrounding air (operating) temperature at U <sub>N</sub>	-40 ... 70 °C
Surrounding air (storage) temperature	-40 ... 85 °C
Pollution degree	2
Max. operating altitude	2000 m

### Standards and specifications

Standards/specifications	EN 61010-2-201; EN 61373; EN 50155
--------------------------	------------------------------------

## Commercial data

Country of origin	DE
GTIN	4055143651752









## Approvals / Certificates

### UL-Approvals

Logo	Approval	Certificate name
	UL Underwriters Laboratories Inc. (ORDINARY LOCATIONS)	E175199 (ORDINARY LOCATIONS)

## Compatible products

### Marking accessories

	<b>Item no.: 2009-110</b> Marking strips; on reel; not stretchable; plain; snap-on type	<a href="http://www.wago.com/2009-110">www.wago.com/2009-110</a>
	<b>Item no.: 2009-115</b> WMB-Inline; for smartPRINTER; on reel; stretchable 5 - 5.2 mm; plain; snap-on type	<a href="http://www.wago.com/2009-115">www.wago.com/2009-115</a>
	<b>Item no.: 2009-115/000-002</b> WMB-Inline; for smartPRINTER; on reel; stretchable 5 - 5.2 mm; plain; snap-on type	<a href="http://www.wago.com/2009-115/000-002">www.wago.com/2009-115/000-002</a>
	<b>Item no.: 2009-115/000-006</b> WMB-Inline; for smartPRINTER; on reel; stretchable 5 - 5.2 mm; plain; snap-on type	<a href="http://www.wago.com/2009-115/000-006">www.wago.com/2009-115/000-006</a>
	<b>Item no.: 2009-115/000-007</b> WMB-Inline; for smartPRINTER; on reel; stretchable 5 - 5.2 mm; plain; snap-on type	<a href="http://www.wago.com/2009-115/000-007">www.wago.com/2009-115/000-007</a>
	<b>Item no.: 2009-115/000-012</b> WMB-Inline; for smartPRINTER; on reel; stretchable 5 - 5.2 mm; plain; snap-on type	<a href="http://www.wago.com/2009-115/000-012">www.wago.com/2009-115/000-012</a>
	<b>Item no.: 2009-115/000-017</b> WMB-Inline; for smartPRINTER; on reel; stretchable 5 - 5.2 mm; plain; snap-on type	<a href="http://www.wago.com/2009-115/000-017">www.wago.com/2009-115/000-017</a>
	<b>Item no.: 2009-115/000-023</b> WMB-Inline; for smartPRINTER; on reel; stretchable 5 - 5.2 mm; plain; snap-on type	<a href="http://www.wago.com/2009-115/000-023">www.wago.com/2009-115/000-023</a>
	<b>Item no.: 2009-115/000-024</b> WMB-Inline; for smartPRINTER; on reel; stretchable 5 - 5.2 mm; plain; snap-on type	<a href="http://www.wago.com/2009-115/000-024">www.wago.com/2009-115/000-024</a>
	<b>Item no.: 793-501</b> WMB marking card; as card; not stretchable; plain; snap-on type	<a href="http://www.wago.com/793-501">www.wago.com/793-501</a>



**Item no.: 793-501/000-002**  
WMB marking card; as card; not stretchable; plain; snap-on type

[www.wago.com/793-501/000-002](http://www.wago.com/793-501/000-002)



**Item no.: 793-501/000-005**  
WMB marking card; as card; not stretchable; plain; snap-on type

[www.wago.com/793-501/000-005](http://www.wago.com/793-501/000-005)



**Item no.: 793-501/000-006**  
WMB marking card; as card; not stretchable; plain; snap-on type

[www.wago.com/793-501/000-006](http://www.wago.com/793-501/000-006)



**Item no.: 793-501/000-007**  
WMB marking card; as card; not stretchable; plain; snap-on type

[www.wago.com/793-501/000-007](http://www.wago.com/793-501/000-007)



**Item no.: 793-501/000-012**  
WMB marking card; as card; not stretchable; plain; snap-on type

[www.wago.com/793-501/000-012](http://www.wago.com/793-501/000-012)



**Item no.: 793-501/000-017**  
WMB marking card; as card; not stretchable; plain; snap-on type

[www.wago.com/793-501/000-017](http://www.wago.com/793-501/000-017)



**Item no.: 793-501/000-023**  
WMB marking card; as card; not stretchable; plain; snap-on type

[www.wago.com/793-501/000-023](http://www.wago.com/793-501/000-023)



**Item no.: 793-501/000-024**  
WMB marking card; as card; not stretchable; plain; snap-on type

[www.wago.com/793-501/000-024](http://www.wago.com/793-501/000-024)



**Item no.: 793-5501**  
WMB marking card; as card; for terminal block width 5 - 17.5 mm; stretchable 5 - 5.2 mm; plain; snap-on type

[www.wago.com/793-5501](http://www.wago.com/793-5501)



**Item no.: 793-5501/000-002**  
WMB marking card; as card; for terminal block width 5 - 17.5 mm; stretchable 5 - 5.2 mm; plain; snap-on type

[www.wago.com/793-5501/000-002](http://www.wago.com/793-5501/000-002)



**Item no.: 793-5501/000-005**  
WMB marking card; as card; stretchable 5 - 5.2 mm; plain; snap-on type

[www.wago.com/793-5501/000-005](http://www.wago.com/793-5501/000-005)



**Item no.: 793-5501/000-006**  
WMB marking card; as card; stretchable 5 - 5.2 mm; plain; snap-on type

[www.wago.com/793-5501/000-006](http://www.wago.com/793-5501/000-006)



**Item no.: 793-5501/000-007**  
WMB marking card; as card; stretchable 5 - 5.2 mm; plain; snap-on type

[www.wago.com/793-5501/000-007](http://www.wago.com/793-5501/000-007)



**Item no.: 793-5501/000-012**  
WMB marking card; as card; stretchable 5 - 5.2 mm; plain; snap-on type

[www.wago.com/793-5501/000-012](http://www.wago.com/793-5501/000-012)



**Item no.: 793-5501/000-014**  
WMB marking card; as card; stretchable 5 - 5.2 mm; plain; snap-on type

[www.wago.com/793-5501/000-014](http://www.wago.com/793-5501/000-014)



**Item no.: 793-5501/000-017**  
WMB marking card; as card; stretchable 5 - 5.2 mm; plain; snap-on type

[www.wago.com/793-5501/000-017](http://www.wago.com/793-5501/000-017)



**Item no.: 793-5501/000-023**  
WMB marking card; as card; stretchable 5 - 5.2 mm; plain; snap-on type

[www.wago.com/793-5501/000-023](http://www.wago.com/793-5501/000-023)



**Item no.: 793-5501/000-024**  
WMB marking card; as card; stretchable 5 - 5.2 mm; plain; snap-on type

[www.wago.com/793-5501/000-024](http://www.wago.com/793-5501/000-024)

## End plate



**Item no.: 2002-1691**  
TOPJOB®S end/intermediate plate; for 2002-16xx series terminal blocks; 1.0 mm wide; gray

[www.wago.com/2002-1691](http://www.wago.com/2002-1691)



**Item no.: 2002-1692**  
TOPJOB®S end/intermediate plate; for 2002-16xx series terminal blocks; 1.0 mm wide; orange

[www.wago.com/2002-1692](http://www.wago.com/2002-1692)



**Item no.: 2002-1791**  
TOPJOB®S end/intermediate plate; for 2002-17xx series terminal blocks; 1.0 mm wide; gray

[www.wago.com/2002-1791](http://www.wago.com/2002-1791)



**Item no.: 2002-1792**  
TOPJOB®S end/intermediate plate; for 2002-17xx series terminal blocks; 1.0 mm wide; orange

[www.wago.com/2002-1792](http://www.wago.com/2002-1792)



**Item no.: 2002-1891**  
TOPJOB®S end/intermediate plate; for 2002-18xx series terminal blocks; 1.0 mm wide; gray

[www.wago.com/2002-1891](http://www.wago.com/2002-1891)



**Item no.: 2002-1892**  
TOPJOB®S end/intermediate plate; for 2002-18xx series terminal blocks; 1.0 mm wide; orange

[www.wago.com/2002-1892](http://www.wago.com/2002-1892)

## Terminal Block



**Item no.: 2002-1661**  
Carrier terminal block; for disconnect; fuse or component plug; rail mount; 2-conductor; 5.2 mm wide; gray

[www.wago.com/2002-1661](http://www.wago.com/2002-1661)



**Item no.: 2002-1761**  
Carrier terminal block; for disconnect; fuse or component plug; rail mount; 3-conductor; 5.2 mm wide; gray

[www.wago.com/2002-1761](http://www.wago.com/2002-1761)



**Item no.: 2002-1861**  
Carrier terminal block; for disconnect; fuse or component plug; rail mount; 4-conductor; 5.2 mm wide; gray

[www.wago.com/2002-1861](http://www.wago.com/2002-1861)



**Item no.: 2002-1961**  
Carrier terminal block; for disconnect; fuse or component plug; with additional jumper location; rail mount; 2-conductor; 5.2 mm wide; gray

[www.wago.com/2002-1961](http://www.wago.com/2002-1961)

## Downloads

### Documentation

### Additional Information



Disposal; Electrical and electronic equipment, Packaging

Oct 15, 2018

Download

265.8 kB

---

### CAD files

#### CAD data

3D Download 2042-3819

URL

Download

---

Subject to changes.

---

WAGO Corporation  
Germantown, WI 53022  
32423 Minden  
Phone: +49571 887-0 | Fax: (262) 255-6222  
Email: [info.us@wago.com](mailto:info.us@wago.com) | Web: [www.wago.com](http://www.wago.com)

Do you have any questions about our products?  
We are always happy to take your call at {0}.