

Features

- Quad, 16-/12-Bit Pin Compatible DACs
TPC116S4: 16 bits
TPC112S4: 12 bits
- Low Power Consumption (800 μ A typ)
- Differential Nonlinearity: ± 1 LSB (max)
- Glitch Energy: 2 nV-s
- Power-on Reset to Zero
- Supply Range: 2.7 V to 5.5 V
- Buffered Rail-to-rail Output Operation
- Safe Power-on Reset (POR) to Zero DAC Output
- Fast 30-MHz, 3-Wire, SPI/QSPI/MICROWIRE-Compatible Serial Interface
- Schmitt-trigger Inputs for Direct Optocoupler Interface
- SYNC Interrupt Facility
- High-performance Drop-in Compatible with TLV5614
- Available in TSSOP-16 Package

Applications

- Gain and Offset Adjustment
- Process Control and Servo Loops
- Programmable Voltage and Current Sources
- Programmable Attenuators
- Automatic Test Equipment

Description

The TPC116S4/TPC112S4 are pin-compatible 16-bit and 12-bit digital-to-analog converters. These products are four-channel, low-power, buffered voltage-out DACs, which are guaranteed monotonic by design. These devices use a precision external reference applied through the high-resistance input for rail-to-rail operation and low system power consumption.

The TPC116S4/TPC112S4 accept a wide range of 2.7 V to 5.5 V supply voltage. The parts incorporate a power-on reset circuit to ensure that the DAC output powers up to 0 V and remains there until a valid write takes place.

The TPC116S4/TPC112S4 on-chip precision output amplifiers allow rail-to-rail output swing to be achieved. For remote sensing applications, the output amplifier's inverting input is available to the user. The TPC116S4/TPC112S4 use a versatile 3-wire serial interface that operate at clock rating up to 30 MHz and are compatible with standard SPI®, QSPI™, MICROWIRE™, and DSP interface standards.

The TPC116S4/TPC112S4 are available in a small-sized 16-pin TSSOP package, all packages are specified over the -40°C to $+125^{\circ}\text{C}$ extended industrial temperature range.

Typical Application Circuit

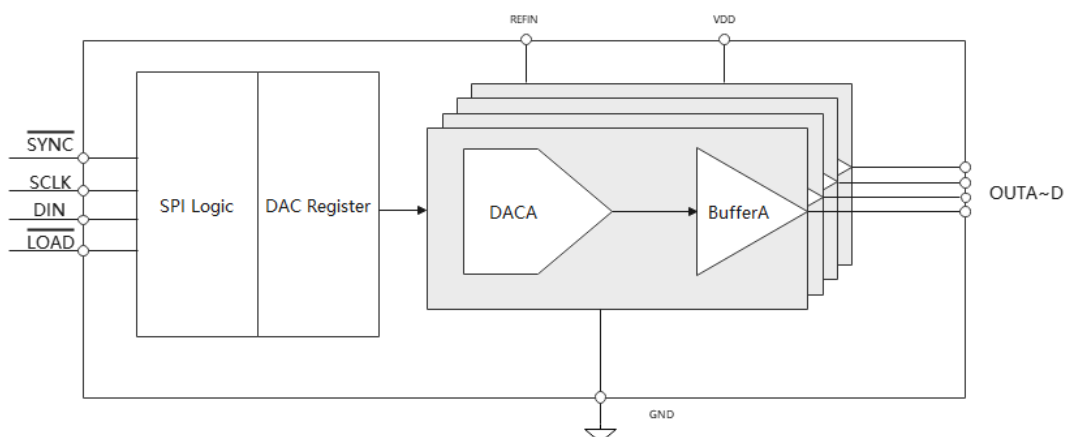

Table of Contents

Features	1
Applications	1
Description	1
Typical Application Circuit	1
Revision History	3
Pin Configuration and Functions	4
Specifications	5
Absolute Maximum Ratings ⁽¹⁾	5
ESD, Electrostatic Discharge Protection	5
Thermal Information	5
Electrical Characteristics	5
Timing Characteristics	8
Typical Performance Characteristics.....	9
Detailed Description	13
Overview.....	13
Functional Block Diagram	13
Application and Implementation	13
DAC Reference (REF).....	13
Serial Interface	14
Tape and Reel Information	15
Package Outline Dimensions	16
TSSOT16.....	16
Order Information	17
IMPORTANT NOTICE AND DISCLAIMER	18

Revision History

Date	Revision	Notes
2022/12/5	Rev.A.4	Updated block diagram

Pin Configuration and Functions

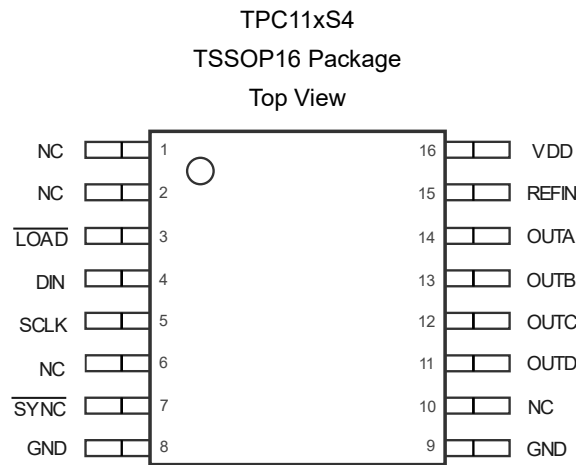

Table 1. Pin Functions: TPC11xS4

Pin	Name	I/O	Description
1	NC	NC	Not connect
2	NC	NC	Not connect
3	$\overline{\text{LOAD}}$	DI	Load DAC. When the LOAD signal is high, no DAC output updates occur when the input digital data is read into the serial interface. The DAC outputs are only updated when LDAC is low.
4	DIN	DI	Serial data input. Data is clocked into the 16-/24-bit input shift register on each falling edge of the serial clock input. Schmitt-Trigger logic input.
5	SCLK	DI	Serial clock input. Data can be transferred at rates up to 30 MHz. Schmitt-Trigger logic input.
6	NC	NC	Not connect
7	$\overline{\text{SYNC}}$	DI	Level-triggered control input (active LOW). This is the frame synchronization signal for the input data. When $\overline{\text{SYNC}}$ goes low, it enables the input shift register, and the data is transferred in on the falling edges of the following clocks.
8	GND	P	Ground reference point for all circuitry on the part.
9	GND	P	Ground reference point for all circuitry on the part.
10	NC	NC	Not connect
11	OUTD	AO	DACD output
12	OUTC	AO	DACC output
13	OUTB	AO	DACB output
14	OUTA	AO	DACA output
15	REFIN	AI	Reference voltage input

16	VDD	P	Power supply input
----	-----	---	--------------------

Specifications

Absolute Maximum Ratings ⁽¹⁾

Parameter	Min	Max	Unit
Supply Voltage: VDD – GND ⁽²⁾		7.0	V
Input Voltage	GND – 0.3	VDD + 0.3	V
Input Current: +IN, –IN ⁽³⁾	–20	+20	mA
Output Short-Circuit Duration ⁽⁴⁾		Infinite	
T _J		150	°C
T _A	–40	125	°C
T _{STG}	–65	150	°C
T _L		260	°C

(1) Stresses beyond those listed under Absolute Maximum Ratings may cause permanent damage to the device. Exposure to any Absolute Maximum Rating condition for extended periods may affect device reliability and lifetime.

(2) The supplies must be established simultaneously, with, or before, the application of any input signals.

(3) The inputs are protected by ESD protection diodes to each power supply. If the input extends to more than 500 mV beyond the power supply, the input current should be limited to less than 10 mA.

(4) A heat sink may be required to keep the junction temperature below the absolute maximum. This depends on the power supply voltage and how many amplifiers are shorted. Thermal resistance varies with the amount of PC board metal connected to the package. The specified values are for short traces connected to the leads.

ESD, Electrostatic Discharge Protection

Symbol	Parameter	Condition	Minimum Level	Unit
HBM	Human Body Model ESD	ANSI/ESDA/JEDEC JS-001 ⁽¹⁾	8	kV
CDM	Charged Device Model ESD	ANSI/ESDA/JEDEC JS-002 ⁽²⁾	2	kV

(1) JEDEC document JEP155 states that 500-V HBM allows safe manufacturing with a standard ESD control process.

(2) JEDEC document JEP157 states that 250-V CDM allows safe manufacturing with a standard ESD control process.

Thermal Information

Package Type	θ_{JA}	θ_{JC}	Unit
TSSOP16	180	35	°C/W

Electrical Characteristics

All test conditions: VDD = 5 V, VREF = 5 V, CL = 100 pF, RL = 10 k Ω , TA = –40°C to +105°C, unless otherwise noted. Typical values are at TA = +25°C.

Symbol	Parameter	Conditions	Min	Typ	Max	Units
Static Accuracy ⁽⁵⁾						
N	Resolution	TPC112S4	12			Bits
		TPC116S4	16			
INL	Integral Nonlinearity	TPC112S4 (12-bit) ⁽⁶⁾	-2	±0.25	2	LSB
		TPC116S4 (16-bit) ⁽⁶⁾	-16	±8	16	
DNL	Differential Nonlinearity	TPC112S4 (12-bit) ⁽⁶⁾	-1	±0.05	1	LSB
		TPC116S4 (16-bit) ⁽⁶⁾	-1	±0.5	1	
OE	Zero Offset Error			6.5	30	mV
	Full-Scale Offset Error		-30	0	30	mV
	Offset-Error Drift			±1		μV/°C
GE	Gain Error		-0.3	±0.1	0.3	%FS
	Gain Temperature Coefficient			±2		ppmF S/°C
Reference Input						
V _{REF}	Reference-Input Voltage		0.5		V _{DD}	V
R _{REF}	Reference-Input Impedance			333		kΩ
DAC Output						
	Output Voltage Range	No load (typical)			V _{REF}	V
		10 kΩ load	0.2		V _{REF} -0.1	
	DC Output Impedance			0.1		Ω
C _L	Capacitive Load ⁽⁸⁾	Series resistance = 0 Ω			0.1	nF
		Series resistance = 1 kΩ			15	μF
R _L	Resistive Load ⁽⁸⁾		5			kΩ
	Short-Circuit Current	V _{DD} = 5.5 V		35		mA
	Power-Up Time	From power-down mode		25		μs
DIGITAL INPUTS (SCLK, DIN, SYNC)						
V _{IH}	Input High Voltage	V _{DD} = 5 V	2			V
		V _{DD} = 3.3 V	1.5			V
V _{IL}	Input Low Voltage	V _{DD} = 5 V			0.6	V
		V _{DD} = 3.3 V			0.4	V
I _{IN}	Input Leakage Current	V _{IN} = 0 V or V _{DD}		±5	±10	μA
C _{IN}	Input Capacitance			1		pF

Electrical Characteristics (Continued)

All test conditions: VDD = 5 V, VREF = 5 V, CL = 100 pF, RL = 10 kΩ, TA = -40°C to +105°C, unless otherwise noted. Typical values are at TA = +25°C.

Symbol	Parameter	Conditions	Min	Typ	Max	Units
V _{HYS}	Hysteresis Voltage			0.15		V
Dynamic Performance ⁽⁶⁾						
SR	Voltage-Output Slew Rate	Positive and negative		1		V/μs
BW	Voltage-Output Settling Time	1/4 scale to 3/4 scale, to ≤ 0.5 LSB, 12-bit		14		μs
	Reference -3dB Bandwidth	Hex code = 800 (TPC112S4), Hex code = 8000 (TPC116S4)		100		kHz
	Digital Feedthrough	Code = 0, all digital inputs from 0V to VDD, SCLK < 50 MHz		0.5		nV • s
	DAC Glitch Impulse	Major code transition		2		nV • s
	Output Noise	10 kHz		90		nV/√Hz
	Integrated Output Noise	0.1 Hz to 10 Hz		25		μV _{P-P}
Power Requirements						
V _{DD}	Supply Voltage		2.7		5.5	V
I _{DD}	Supply Current	V _{DD} = 5 V, No load; all digital inputs at 0 V or V _{DD} , supply current only; excludes reference input current, midscale		0.8	1.5	mA
I _{DD}	Supply Current	V _{DD} = 3.3 V, No load; all digital inputs at 0 V or V _{DD} , supply current only; excludes reference input current, midscale		0.5	1	mA
	Power-Down Supply Current	No load, all digital inputs at 0 V or V _{DD}			500	μA

(5) Linearity is tested within 20 mV of GND and VDD.

(6) Gain and offset are tested within 100 mV of GND and VDD.

(7) All timing specifications are measured with VIL = VGND, VIH = VDD.

Timing Characteristics

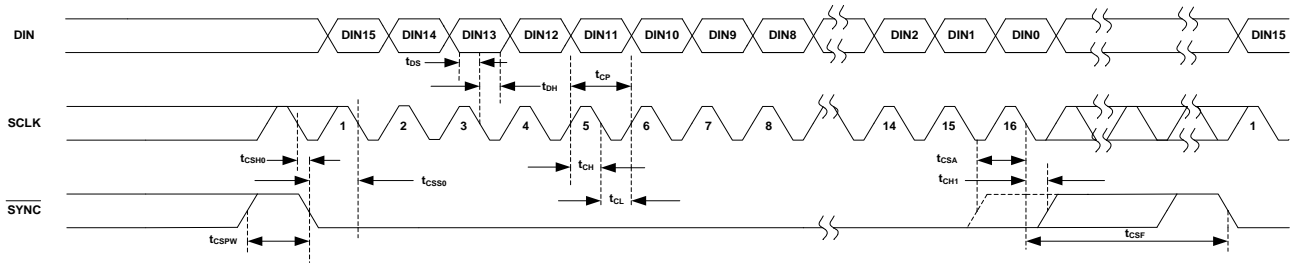

Figure 1. 16-Bit Serial-Interface Timing Diagram (TPC112S4)

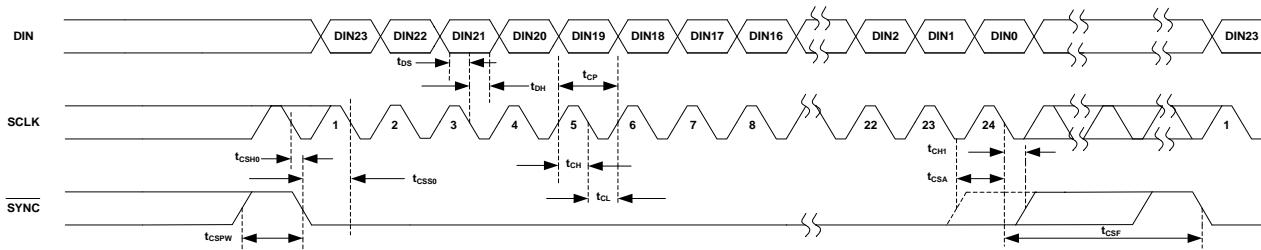

Figure 2. 24-Bit Serial-Interface Timing Diagram (TPC116S4)

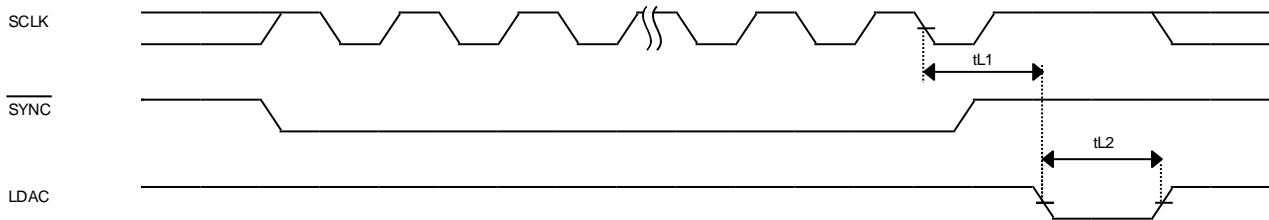

Figure 3. LDAC Timing Diagram

Timing Characteristics (Figures 1,2 and 3)

Symbol	Parameter	Conditions	Min	Typ	Max	Units
f_{SCLK}	Serial Clock Frequency		0		30	MHz
t_{CH}	SCLK Pulse-Width High		8			ns
t_{CL}	SCLK Pulse-Width Low		8			ns
t_{CSS0}	SYNC Fall to SCLK Fall		8			ns
t_{CSH0}	SYNC Fall to SCLK Fall		0			ns
t_{CSH1}	SYNC Rise to SCLK Fall		0			ns
t_{CSA}	SYNC Rise to SCLK Fall				12	ns
t_{CSF}	SCLK Fall to SYNC Fall		100			ns
t_{DS}	DIN to SCLK Fall Setup		5			ns
t_{DH}	DIN to SCLK Fall Hold Time		4.5			ns
t_{CSPW}	SYNC Pulse-Width High		20			ns
t_{CLPW}	SYNC Pulse-Width Low		20			ns
t_{CSC}	SYNC Rise to SYNC Fall		20			ns
t_{L1}	SCLK falling edge to LDAC falling edge for		50			ns
t_{L2}	LDAC pulse width LOW		50			ns

Typical Performance Characteristics

All test conditions: $V_S = 5\text{ V}$, $T_A = +25^\circ\text{C}$, unless otherwise specified.

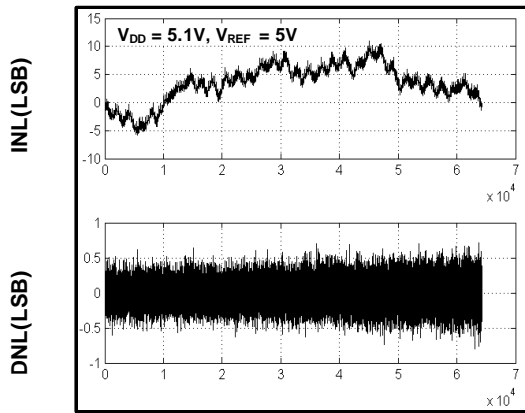

Digital Input Code

Figure 4. INL and DNL vs. Digital Input Code (+25°C TPC116S4)

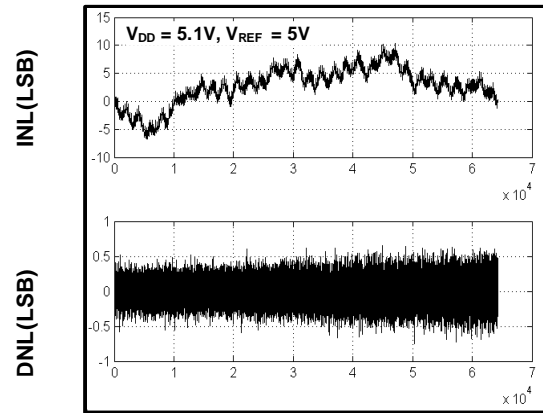

Digital Input Code

Figure 5. INL and DNL vs. Digital Input Code (-40°C TPC116S4)

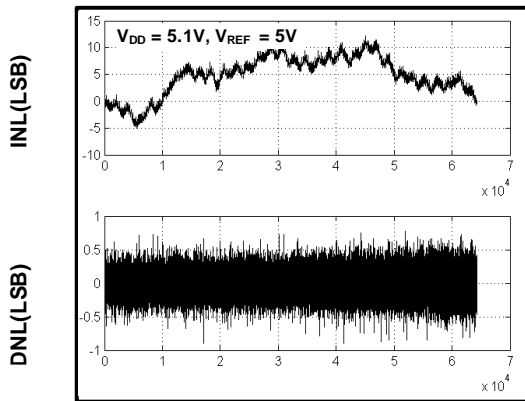

Digital Input Code

Figure 6. INL and DNL vs. Digital Input Code (+105°C TPC116S4)

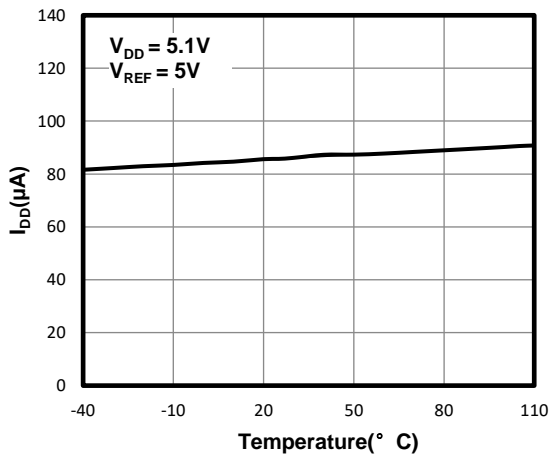

Figure 7. Power-Supply Current vs. Temperature (TPC116S4)

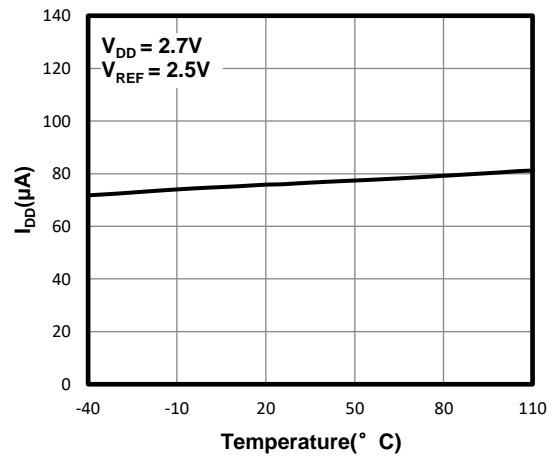

Figure 8. Power-Supply Current vs. Temperature (TPC116S4)

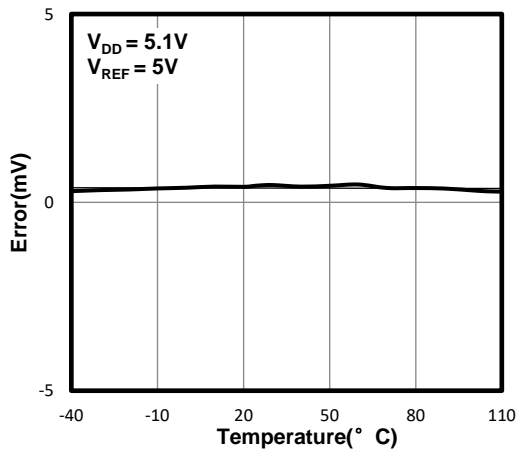

Figure 9. Zero-Scale Error vs. Temperature (TPC116S4)

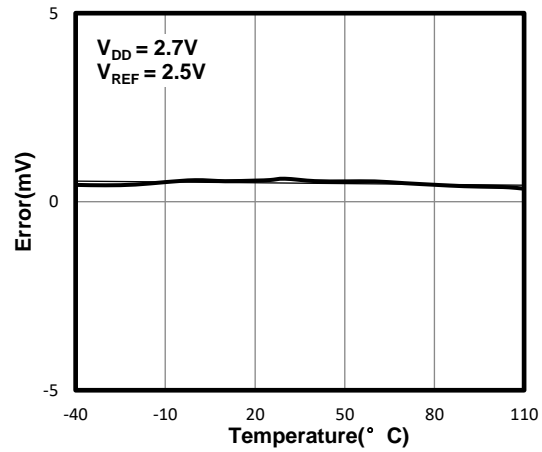

Figure 10. Zero-Scale Error vs. Temperature (TPC116S4)

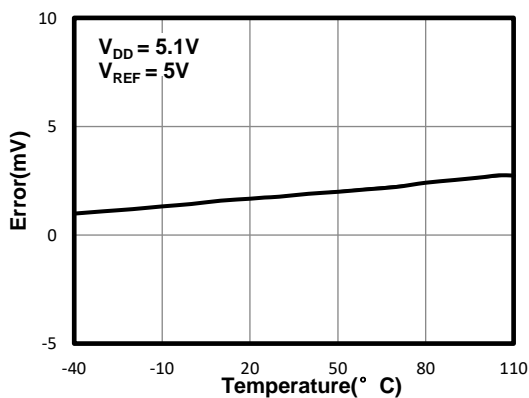

Figure 11. Full-Scale Error vs. Temperature (TPC116S4)

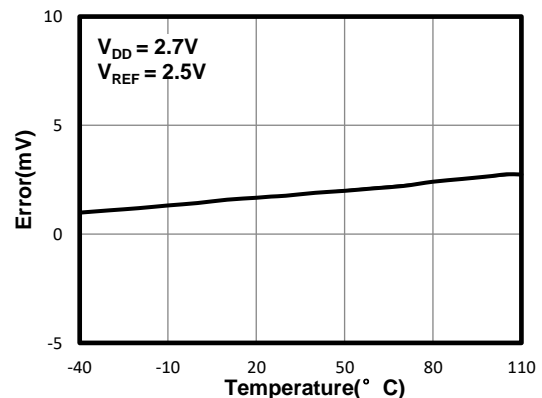

Figure 12. Full-Scale Error vs. Temperature (TPC116S4)

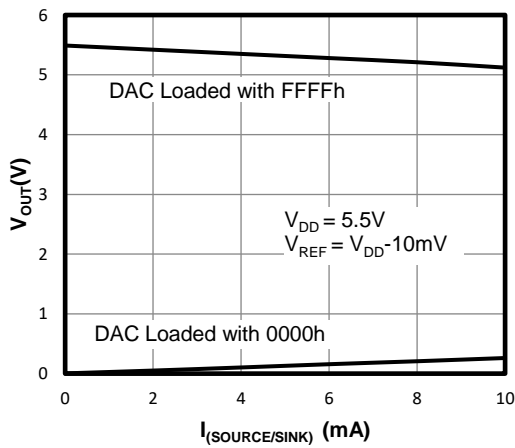

Figure 13. Source and Sink Current Capability(TPC116S4)

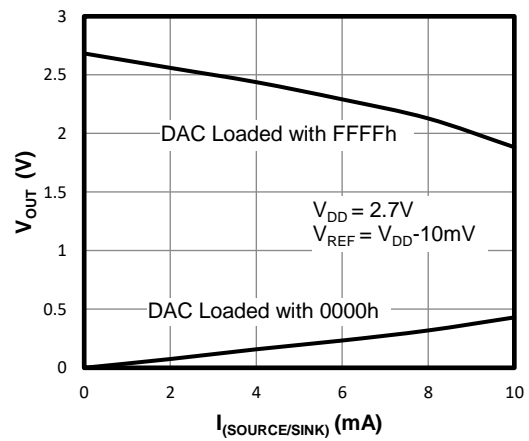

Figure 14. Source and Sink Current Capability(TPC116S4)

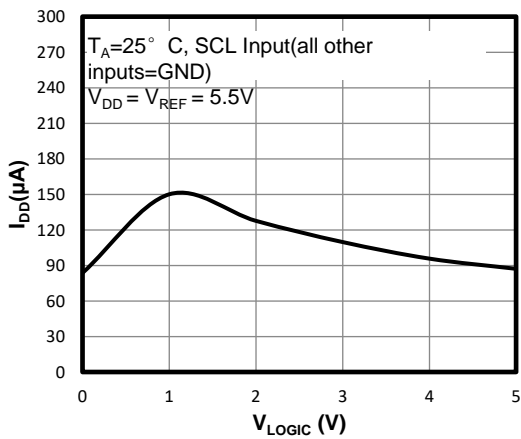

Figure 15. Supply Current vs. Logic Input Voltage(TPC116S4)

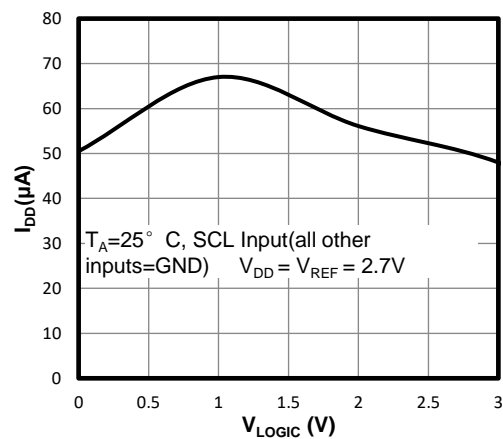

Figure 16. Supply Current vs. Logic Input Voltage(TPC116S4)

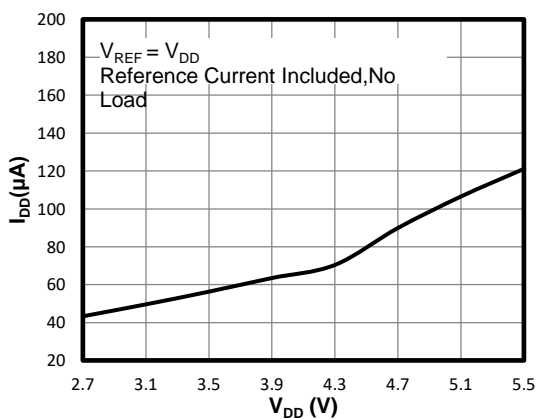

Figure 17. Supply Current vs. Supply Voltage (TPC116S4)

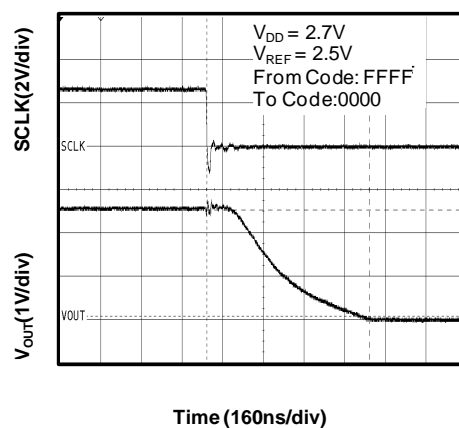
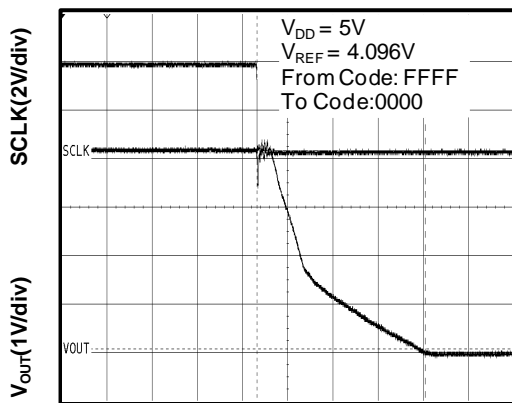
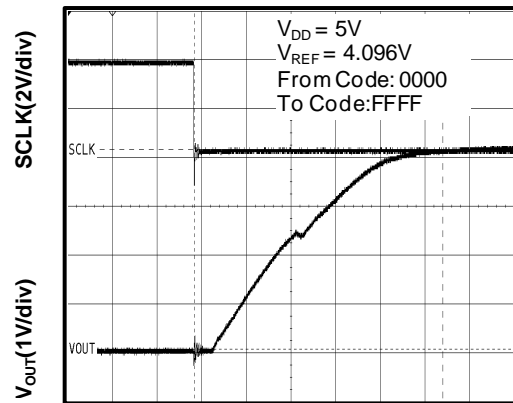

Figure 18. Full-Scale Settling Time (2.7-V Falling Edge)



Time (250ns/div)

Figure 19. Full-Scale Settling Time (5-V Falling Edge)



Time (500ns/div)

Figure 20. Full-Scale Settling Time (5-V Rising Edge)

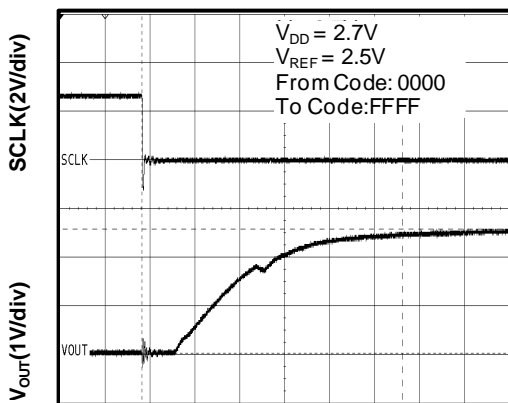

Time (430ns/div)

Figure 21. Full-Scale Settling Time (2.7-V Rising Edge)

Detailed Description

Overview

The TPC116S4 and TPC112S4 are pin-compatible and software-compatible 12-bit and 16-bit DACs. The TPC116S4 and TPC112S4 are 4-channel, low-power, high-reference input resistance, and buffered voltage-output DACs. The TPC116S4 and TPC112S4 minimize the digital noise feed through from their inputs to their outputs by powering down the SCLK and DIN input buffers after the completion of each data frame. The data frames are 16-bit for the TPC112S4 and 24-bit for the TPC116S4. On power-up, the TPC116S4 and TPC112S4 reset the DAC output to zero, providing additional safety for applications that drive valves or other transducers which need to be off on powering up. The TPC116S4 and TPC112S4 contain a segmented resistor string-type DAC, a serial-in/parallel-out shift register, a DAC register, power-on-reset (POR) circuit, and control logic. On the falling edge of the clock (SCLK) pulse, the serial input (DIN) data is shifted into the device, MSB first.

Functional Block Diagram

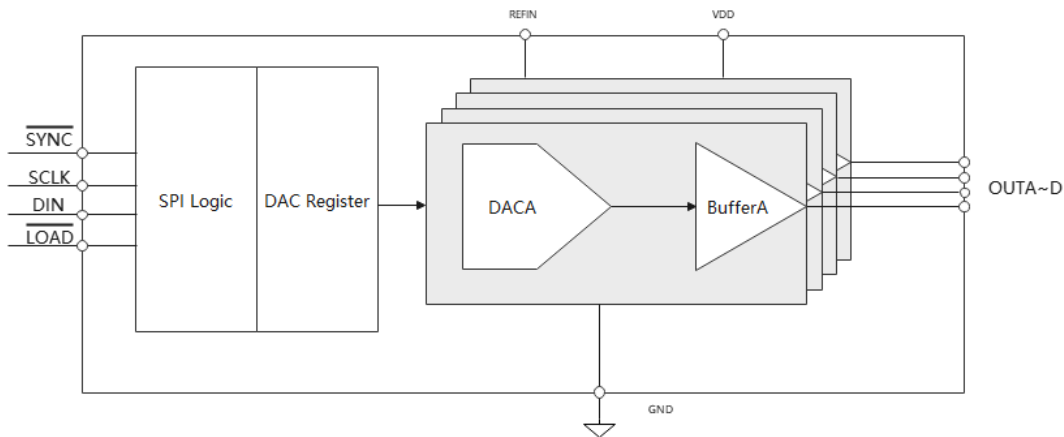

Figure 22. Functional Block Diagram

Application and Implementation

NOTE

Information in the following applications sections is not part of the 3PEAK's component specification and 3PEAK does not warrant its accuracy or completeness. 3PEAK's customers are responsible for determining suitability of components for their purposes. Customers should validate and test their design implementation to confirm system functionality.

DAC Reference (REF)

The external reference input features a typical input impedance of 333 k Ω and accepts an input voltage from +2 V to VDD. Connect an external voltage supply between REF and GND to apply an external reference.

Serial Interface

The TPC116S4/TPC112S4 3-wire serial interface is compatible with MICROWIRE, SPI, QSPI, and DSP. The interface provides three inputs: SCLK, SYNC, and DIN. The chip-select input (SYNC) frames the serial data loading at DIN. Following a chip-select input high-to-low transition, the data is shifted synchronously and latched into the input register on each falling edge of the serial-clock input (SCLK). Each serial word is 16-bit for the TPC112S4 and 24-bit for the TPC116S4. The first 3 bits are the control bits followed by 1 power-down bit as well as 12-data bits (MSB first) for the TPC112S4 and 22-data bits (MSB first) for the TPC116S4 as shown in Table 1 and Table 2. The serial input register transfers its content to the input registers after loading 16/24 bits of data and updates the DAC output immediately after the data is received on the 16-/24-bit falling edge of the clock. To initiate a new data transfer, drive SYNC high and keep SYNC high for a minimum of 20 ns before the next write sequence. The SCLK can be either high or low between SYNC write pulses. Figures 1 and Figure 2 show the timing diagram for the complete 3-wire serial interface transmission. The TPC116S4 DAC code is unipolar binary with $V_{OUT} = (\text{code}/65,536) \times V_{REF}$. The TPC112S4 DAC code is unipolar binary with $V_{OUT} = (\text{code}/4096) \times V_{REF}$.

Table 1. Operating Mode Truth Table (TPC112S4)

16-Bit Word																Function
A2	A1	A0	PD	DAC Data Bit												
D1 5	D1 4	D1 3	D1 2	D11	D10	D9	D8	D7	D6	D5	D4	D3	D2	D1	D0	
1	0	0	0	X	X	X	X	X	X	X	X	X	X	X	X	Update DAC A Data
1	0	1	0	X	X	X	X	X	X	X	X	X	X	X	X	Update DAC B Data
1	1	0	0	X	X	X	X	X	X	X	X	X	X	X	X	Update DAC C Data
1	1	1	0	X	X	X	X	X	X	X	X	X	X	X	X	Update DAC D Data
X	X	X	1	X	X	X	X	X	X	X	X	X	X	X	X	Power down

Table 2. Operating Mode Truth Table (TPC116S4)

24-Bit Word																	Function			
				A2	A1	A0	PD	DAC Data Bit												
D2 3	D2 2	D2 1	D2 0	D1 9	D1 8	D1 7	D1 6	D1 5	D1 4	D1 3	D1 2	D1 1	D1 0	D 9	D 8	D7 ~ D0				
X	X	X	X	1	0	0	0	X	X	X	X	X	X	X	X	Update DAC A Data				
X	X	X	X	1	0	1	0	X	X	X	X	X	X	X	X	Update DAC B Data				
X	X	X	X	1	1	0	0	X	X	X	X	X	X	X	X	Update DAC C Data				
X	X	X	X	1	1	1	0	X	X	X	X	X	X	X	X	Update DAC D Data				
X	X	X	X	X	X	X	1	X	X	X	X	X	X	X	X	Power down				

Tape and Reel Information

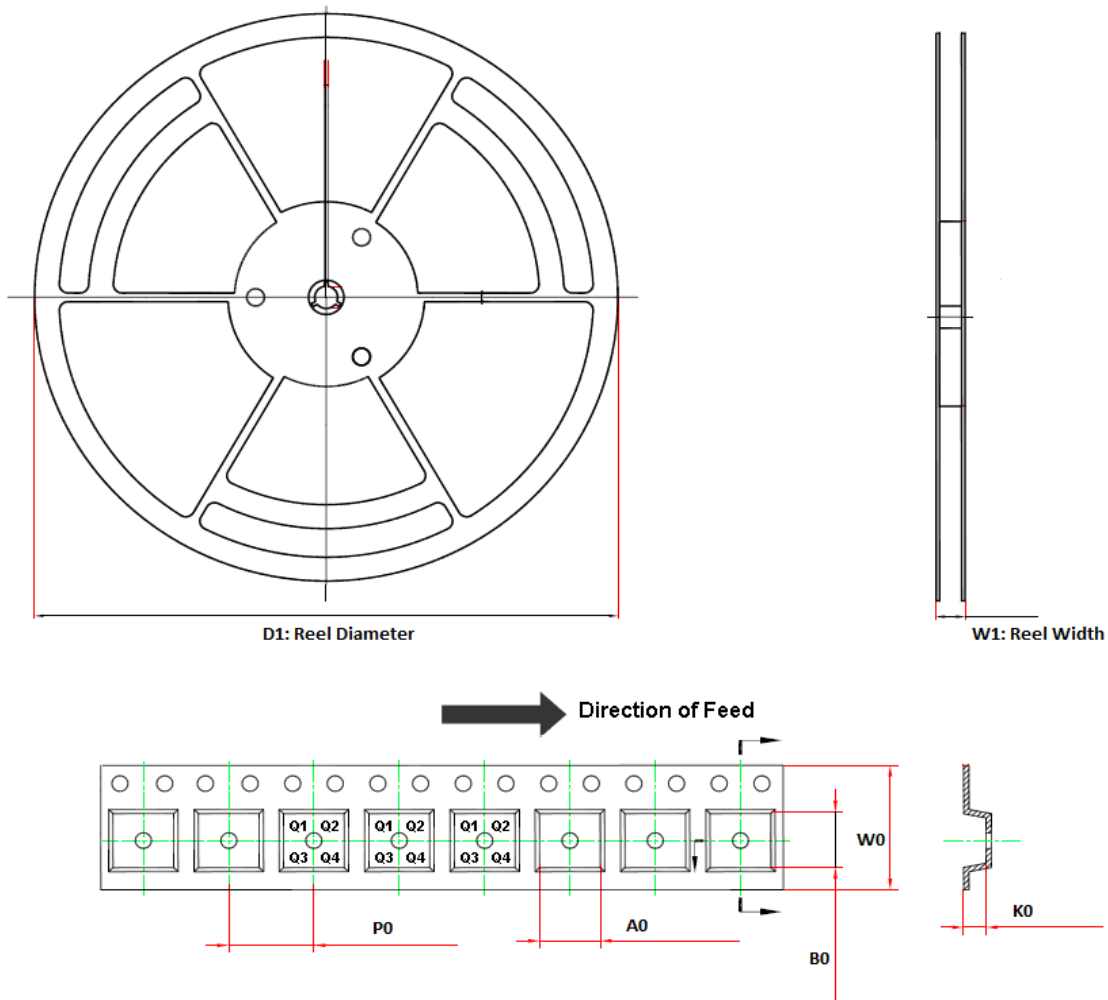

Order Number	Package	D1 (mm)	W1 (mm)	A0 (mm)	B0 (mm)	K0 (mm)	P0 (mm)	W0 (mm)	Pin1 Quadrant
TPC112S4-TR	TSSOP-16	330	17.6	6.8	5.4	1.3	8	12	Q1
TPC116S4-TR	TSSOP-16	330	17.6	6.8	5.4	1.3	8	12	Q1

Package Outline Dimensions

TSSOT16

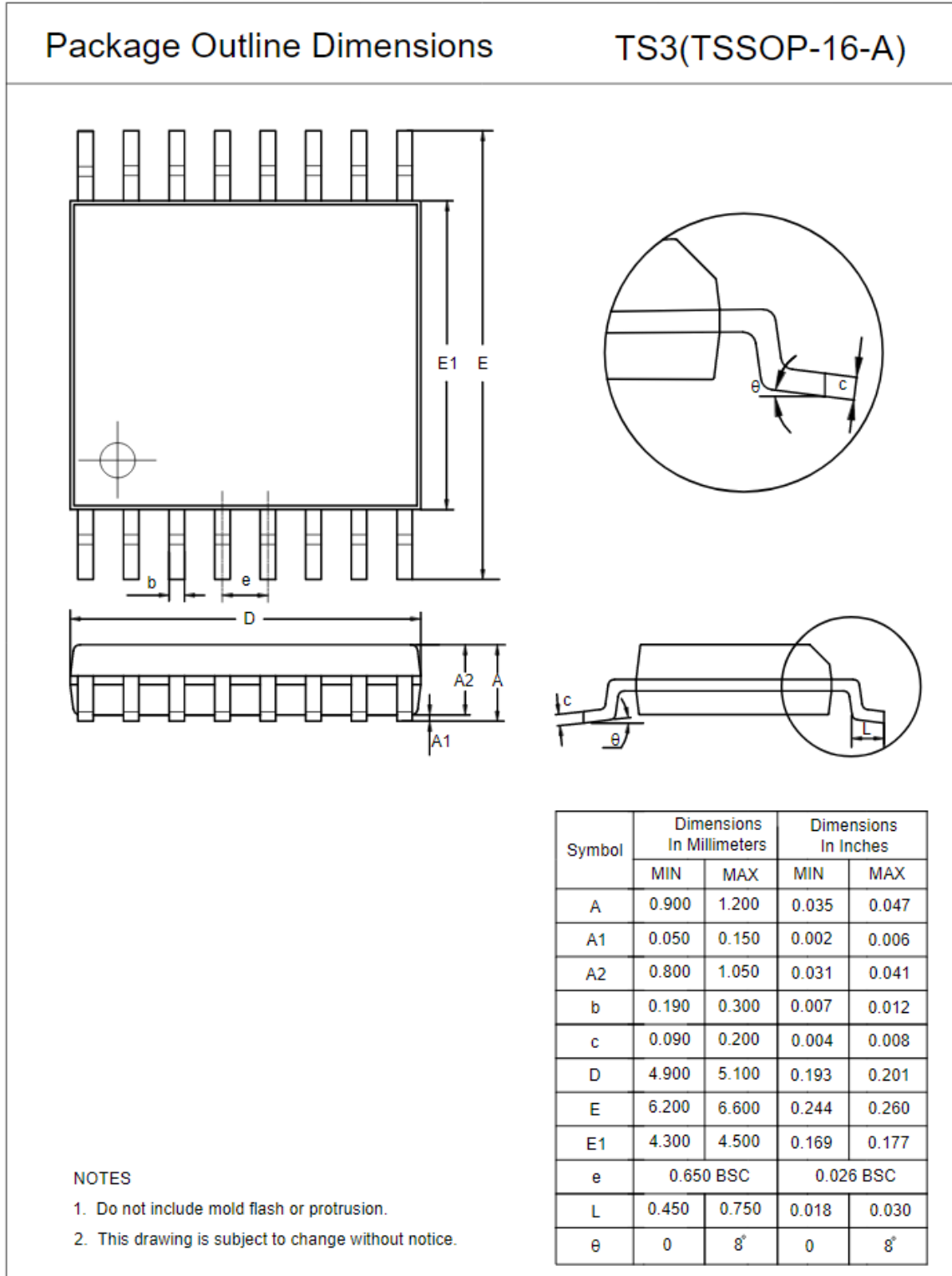

Order Information

Order Number	Operating Temperature Range	Package	Marking Information	MSL	Transport Media, Quantity	Eco Plan
TPC112S4-TR	-40 to 125°C	TSSOP16	112S4	1	Tape and Reel, 3000	Green
TPC116S4-TR	-40 to 125°C	TSSOP16	116S4	1	Tape and Reel, 3000	Green

(1) For Future products, contact the 3PEAK factory for more information and samples.

Green: 3PEAK defines "Green" to mean RoHS compatible and free of halogen substances.

IMPORTANT NOTICE AND DISCLAIMER

Copyright© 3PEAK 2012-2023. All rights reserved.

Trademarks. Any of the 思瑞浦 or 3PEAK trade names, trademarks, graphic marks, and domain names contained in this document /material are the property of 3PEAK. You may NOT reproduce, modify, publish, transmit or distribute any Trademark without the prior written consent of 3PEAK.

Performance Information. Performance tests or performance range contained in this document/material are either results of design simulation or actual tests conducted under designated testing environment. Any variation in testing environment or simulation environment, including but not limited to testing method, testing process or testing temperature, may affect actual performance of the product.

Disclaimer. 3PEAK provides technical and reliability data (including data sheets), design resources (including reference designs), application or other design recommendations, networking tools, security information and other resources "As Is". 3PEAK makes no warranty as to the absence of defects, and makes no warranties of any kind, express or implied, including without limitation, implied warranties as to merchantability, fitness for a particular purpose or non-infringement of any third-party's intellectual property rights. Unless otherwise specified in writing, products supplied by 3PEAK are not designed to be used in any life-threatening scenarios, including critical medical applications, automotive safety-critical systems, aviation, aerospace, or any situations where failure could result in bodily harm, loss of life, or significant property damage. 3PEAK disclaims all liability for any such unauthorized use.