

客户 Customer: _____

日期 DATE: _____

纳入仕様书 SPECIFICATION

产品名称 PRODUCT NAME: 声表滤波器

SAW Filter

贵司料号 YOUR PART NO.:

敝司料号 OUR PART NO.: MS11U2G35-RX40C

版本号 VERSION.: V1.4

接受 RECEPTION THE SPECIFICATION HAS BEEN ACCEPTED. 该纳入仕様书已被我司接受 日期: DATE: 公司: COMPANY:		
批准 CFMD	审核 CHKD	接收 RCVD

深圳市麦捷微电子科技股份有限公司
SHENZHEN MICROGATE TECHNOLOGY CO., LTD
TEL: 86-755-28085000
FAX: 86-755-28085605

CFMD. 批准	CHKD. 审核	DSGD. 担当
姚艳龙	赖定权	赵新佳

纳入仕様书改定履历

MODIFY HISTORY OF SPECIFICATION

NO.	修改日期/DATE	修改内容/CONTENT	批准/APPROVED
1.0	2015.10.23	初稿 /New Released	梁启新
1.1	2017.12.20	修改带外抑制分段/Modify Absolute Attenuation Band	梁启新
1.2	2018.09.26	版本升级/Version Upgrade	姚艳龙
1.3	2018.12.16	版本升级/Version Upgrade	姚艳龙
1.4	2019.05.08	版本升级/Version Upgrade	姚艳龙

目录 CATALOG

1 适用范围 Scope.....	4
2 品名构成 Product Identification.....	4
3 尺寸和管脚定义 Dimensions and PIN Configurations.....	4
4 推荐焊盘与测试电路 Recommended Land Pattern and Test Circuit.....	4
5 电气性能 Electrical Characteristics.....	5
6 包装 Packaging.....	8
7 装箱清单及标志 Packing documents and marking.....	9
8 保管 Storage.....	11

1 适用范围 Scope

麦捷声表滤波器系列产品设计用于 WIFI、GPS、移动电话和无绳电话机等相关市场中。
Microgate SAW Component is applicable for WIFI/GPS/Mobile phone/Cordless phone relevant market.

2 品名构成 Product Identification

MS 11 U 2G35 - RX 40 C
① ② ③ ④ ⑤ ⑥ ⑦

- ① 麦捷声表滤波器/Microgate SAW
- ② 尺寸/Size: (20-2016, 18-1814, 15-1511, 14-1411, 11-1109)
- ③ 输出/Output: (B-Balance out, U-Unbalance out)
- ④ 频率/Frequency: (2G35-2.35GHz)
- ⑤ 型号/Type: (QP-QPX, DU-Duplexer, DI-Diplexer, TX-TX SAW, RX-RX SAW)
- ⑥ 频段/Band: 40-Band40
- ⑦ 流水号/Serial number

3 尺寸和管脚定义 Dimensions and PIN Configurations

Unit:mm

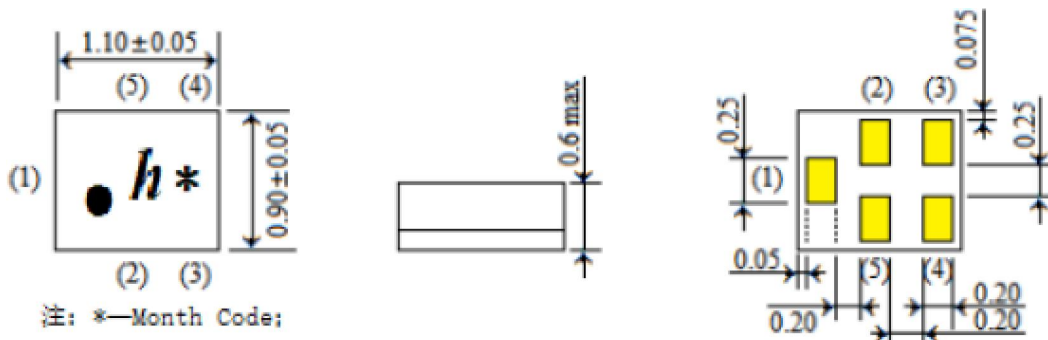

PIN NO.	(1)	(2)	(3)	(4)	(5)
PIN Name	Input	GND	GND	Output	GND

4 推荐焊盘与测试电路 Recommended Land Pattern and Test Circuit

Land Pattern

Test Circuit

Unit:mm

Bottom View

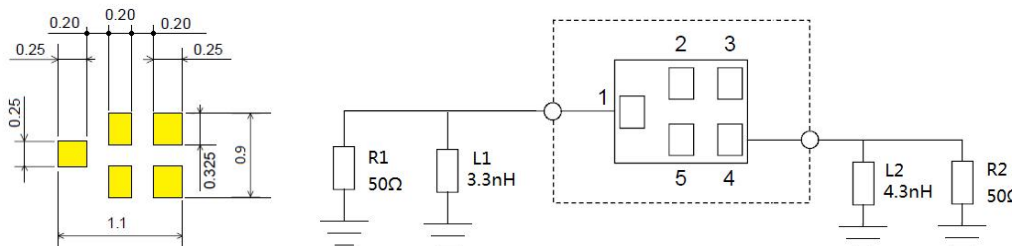

深圳市麦捷微电子科技股份有限公司

地址: 深圳市龙华新区观澜街道高尔夫大道裕新路 65 号

电话(Tel): 0755-28085000

传真(Fax): 0755-28085605

邮编(Postcode): 518110

4

5 电气性能 Electrical Characteristics

操作温度范围 Operating Temperature Range : -20 to +85°C

保存温度范围 Storage Temperature Range : -40 to +85°C

测试温度范围 Test Temperature: 25°C±2°C

湿度敏感等级 Moisture Sensitivity Level: MSL 2a

静电敏感等级 Electrostatic Discharge(ESD) Sensitivity: 250V (Human Body Model)

端口电压 D.C. Volatage between the terminals: 3V (25°C±2°C)

Table1. Electrical Specification

No.	Item		Frequency (MHz)	Specification			Unit
				Min	Max	Typ.	
1	ANT to Rx	Insertion Loss	2300 ~2400		2.8	1.9	dB
2		Ripple Deviation	2300 ~2400		2.3	1.2	dB
3		Absolute Attenuation	10~1574	20		32	dB
4			1574~1577	20		32	dB
5			1577~1680	20		30	dB
6			1845~1880	18		28	dB
7			2110~2170	18		30	dB
8			2240~2285	1.5		4	dB
9			2430~2440	13		17	dB
10			2440~2460	28		40	dB
11			2460~2485	30		46	dB
12			2485~2500	30		41	dB
13			2500~3000.	20		26	dB
14			4600~4800	20		38	dB
15			4800~6000	18		42	dB
16		VSWR	2300 ~2400		2.0	1.5	
17	Input Signal Level		Max: 10 dBm				

Frequency Performance

Frequency Response

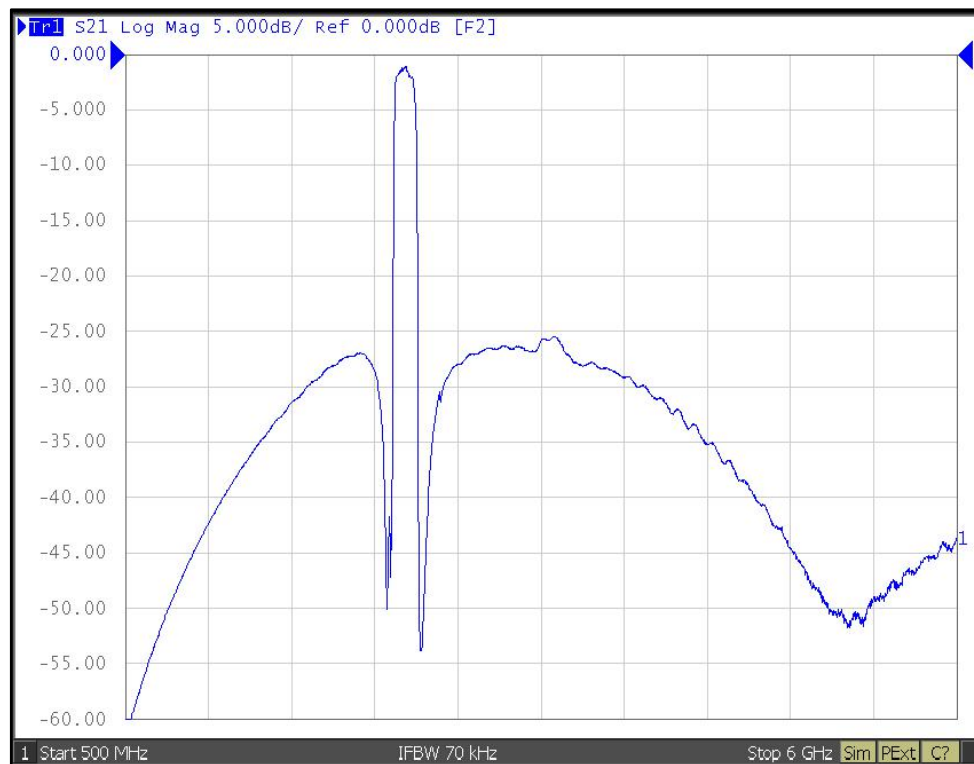
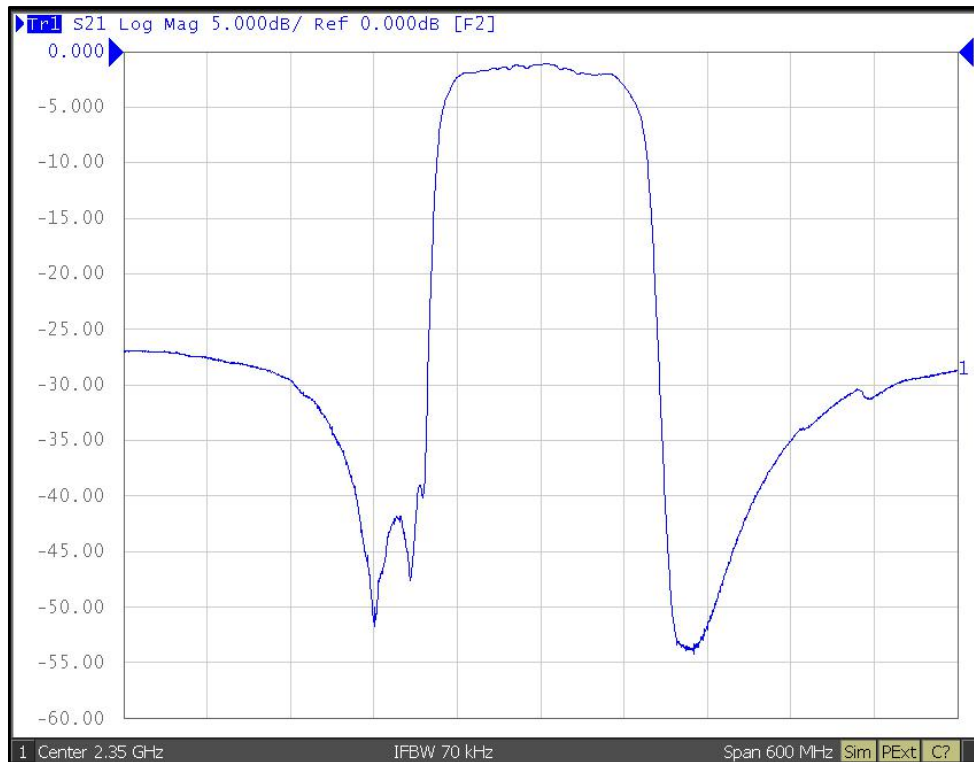

深圳市麦捷微电子科技股份有限公司

地址：深圳市龙华新区观澜街道高尔夫大道裕新路 65 号

电话(Tel): 0755-28085000

传真(Fax): 0755-28085605

邮编(Postcode): 518110

VSWR

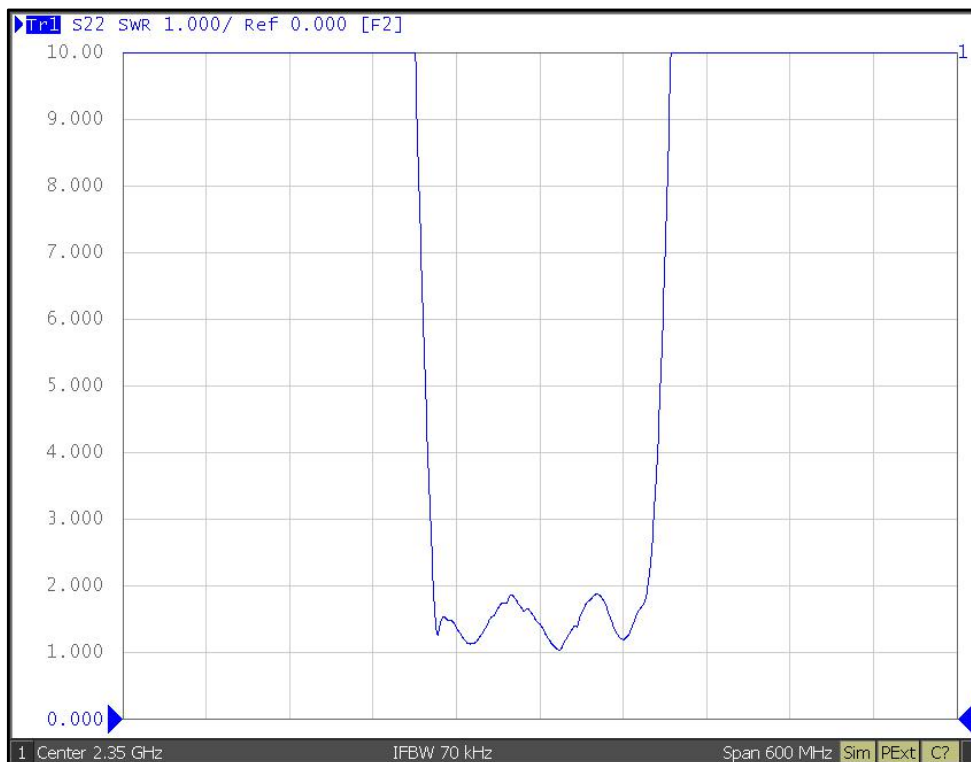
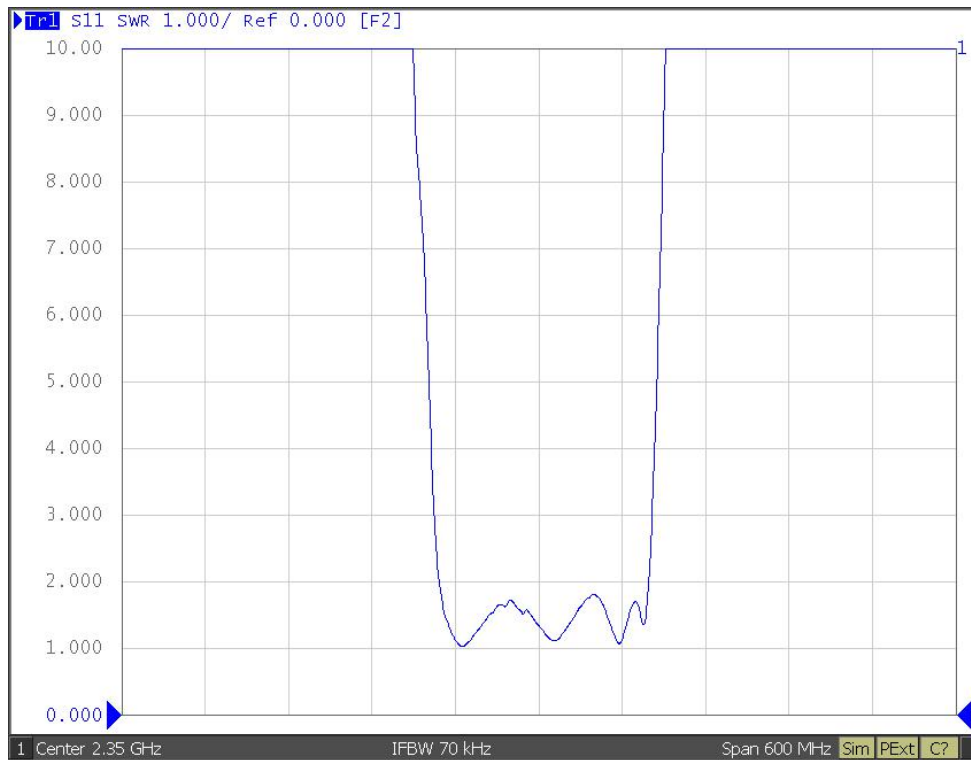

深圳市麦捷微电子科技股份有限公司

地址：深圳市龙华新区观澜街道高尔夫大道裕新路 65 号

电话(Tel): 0755-28085000

传真(Fax): 0755-28085605

邮编(Postcode): 518110

6 包装 Packaging

① 编带尺寸 Dimensions of Tape:

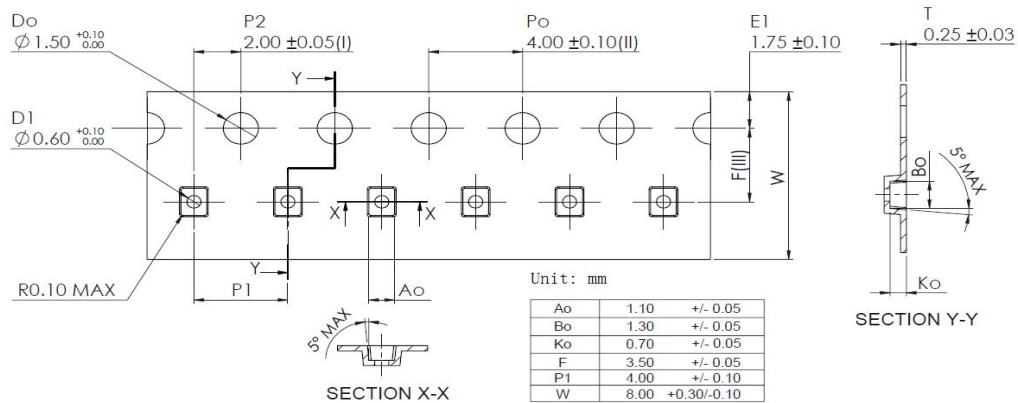

② 带轮尺寸 Dimensions of Reel

Unit: mm

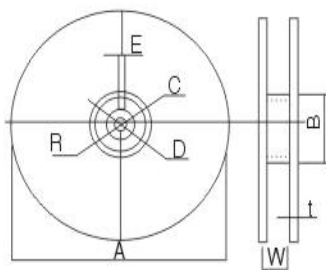

A	178±2
B	60±2
C	13.0±0.5
D	21.0±0.8
E	2.0±0.5
W	8.5±1.0
t	1.2±0.2
R	1.0±0.25

Reel material: PS (Polystyrene)

③ 编带简图及拉伸方向 Taping figure and drawing direction:

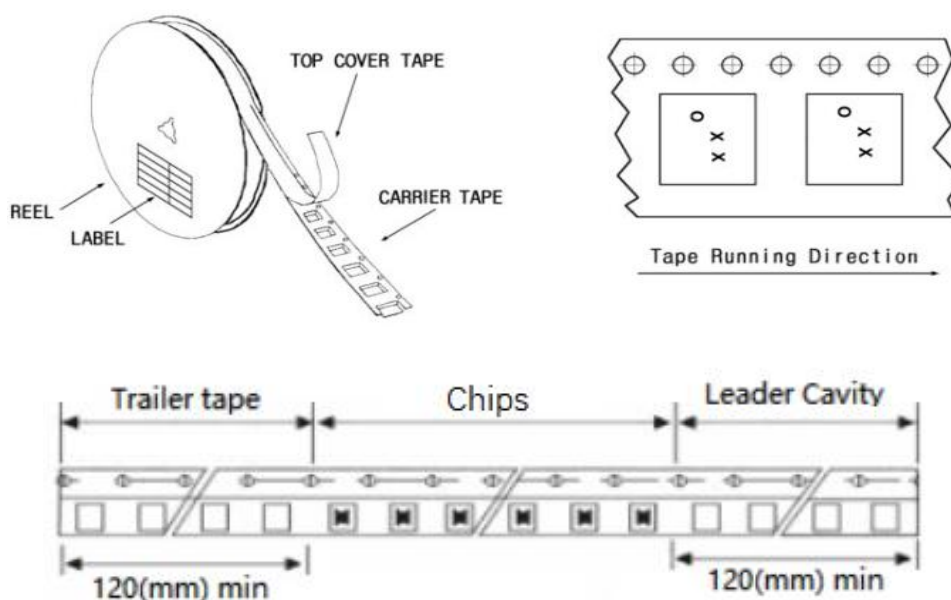

深圳市麦捷微电子科技股份有限公司

地址: 深圳市龙华新区观澜街道高尔夫大道裕新路 65 号

电话(Tel): 0755-28085000

传真(Fax): 0755-28085605

邮编(Postcode): 518110

8

④ 盖带的剥离强度 Peeling strength of cover tape:

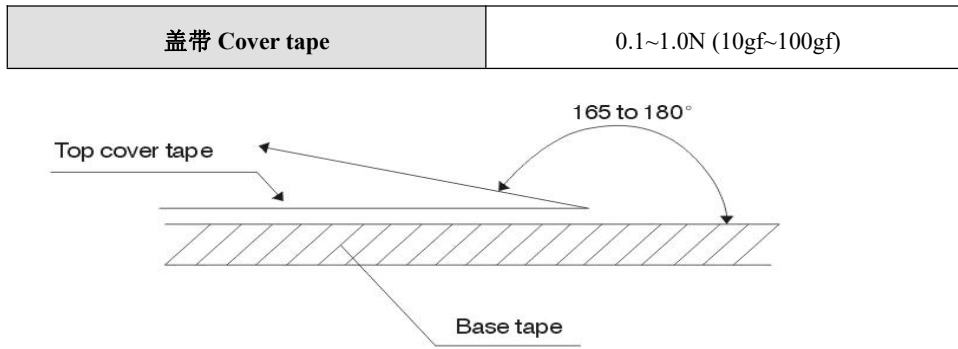

测试条件 Test condition:

- 1) 剥离角度 peel angle: 165°~180° vs. carrier tape.
- 2) 剥离速度 peel speed: 300mm/min±10%.

⑤ 包装数量 Packaging quantities: 5000 PCS / Reel

7 装箱清单及标志 Packing documents and marking

① 包装文件 Packing documents

- a. 装箱清单 Packing list.
- b. 合格证书 Certificate of compliance.

② 盘上标记 Marking on reels:

- a. 麦捷料号 MICROGATE Part No.
- b. 生产批号 Lot number
- c. 盘装数量 Quantity per reel
- d. 检验员号 Inspector No.

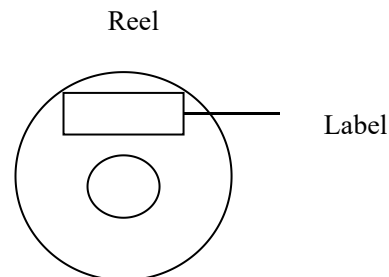

以上内容必须在标签上注明. All above shall be shown on marking label

麦捷公司标签如下所示: MICROGATE marking label will be as following:

MICROGATE		
CUSTOMER:	P. O. NO	
CUSTOMER PART NO:	DATE CODE	LOT NO
MG PART NO:	QUANTITY	INSP. NO

MG PART NO

检验合格后, 检验员在标签上盖上合格章。合格章如下所示: The eligible reels will be pressed a mark onto the surface. The mark will be as following:

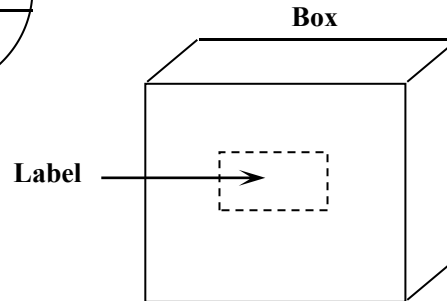
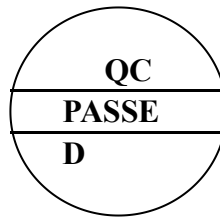

③ 内包装盒标记: Marking on inner box

- a. 型号 MICROGATE part No.
- b. 每盒数量 Quantity per box
- c. 包装日期 Date

以上内容必须在标签上注明 (标签见 7.2 所示)。Above shall be shown on marking label (The marking label is shown in item 7.2).

④ 外包装箱标记 Marking on outer case:

- 1) 制造商 Manufacturer: "MICROGATE" ①
- "中国深圳制造" "Made in Shenzhen CHINA" ②
- 2) 发运标记 Ship marking:
"向上" "UP", "小心轻放" "HAND CARE", "防潮" "MOISTURE-PROOF".
- 3) 包装标签包括以下内容 Packing label include the following:
 - a. 型号 MICROGATE Part No
 - b. 总数量 Total quantity per case
 - c. 包装日期 Date;

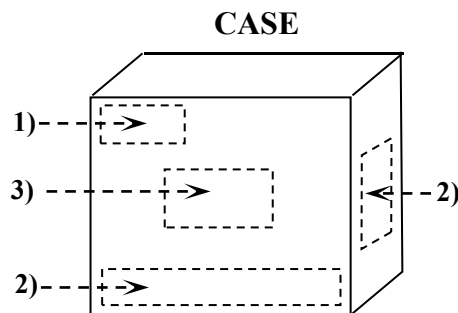

以上内容必须在标签上注明。(参见 7.2 所示)

All above shall be shown on marking label. (The marking label is shown in item 7.2)

8 保管 Storage

保存条件 Storage conditions

- 存放货物的库房应满足以下条件 Products should be storage in the warehouse on the following conditions

温度 Temperature: $\leq 40^{\circ}\text{C}$

湿度 Humidity : $\leq 70\%$ relative humidity

不允许温、湿度有极剧变化。No rapid change on temperature and humidity

- 禁止将产品保管在腐蚀性物质中，例如硫磺、氯气或者酸，否则将引起端头氧化，导致降低焊接性。
Don't keep products in corrosive gases such as sulfur, chlorine gas or acid, or it may cause oxidization of electrode, resulting in poor solder ability.
- 为了避免受潮气、灰尘等物质的影响，产品应保管于货架上。Products should be storage on the palette for the prevention of the influence from humidity, dust and so on.
- 产品保管在库房中时，应避免热冲击，振动以及直接光照等等。Products should be storage in the warehouse without heat shock, vibration, and direct sunlight and so on.
- 产品应密封包装 Products should be storage under the airtight packaged condition.