

isc N-Channel MOSFET Transistor
FCH040N65S3
• FEATURES

- With TO-247 packaging
- Drain Source Voltage-
: $V_{DSS} \geq 650V$
- Static drain-source on-resistance:
 $R_{DS(on)} \leq 99m\Omega @ V_{GS}=10V$
- 100% avalanche tested
- Minimum Lot-to-Lot variations for robust device performance and reliable operation

• APPLICATIONS

- Power supply
- Switching applications

• ABSOLUTE MAXIMUM RATINGS($T_a=25^\circ C$)

SYMBOL	PARAMETER	VALUE	UNIT
V_{DSS}	Drain-Source Voltage	650	V
V_{GSS}	Gate-Source Voltage	± 30	V
I_D	Drain Current-Continuous;@ $T_c=25^\circ C$	30	A
I_{DM}	Drain Current-Single Pulsed	75	A
P_D	Total Dissipation	227	W
T_j	Operating Junction Temperature	-55~150	$^\circ C$
T_{stg}	Storage Temperature	-55~150	$^\circ C$

• THERMAL CHARACTERISTICS

SYMBOL	PARAMETER	MAX	UNIT
$R_{th(ch-c)}$	Channel-to-case thermal resistance	0.55	$^\circ C/W$

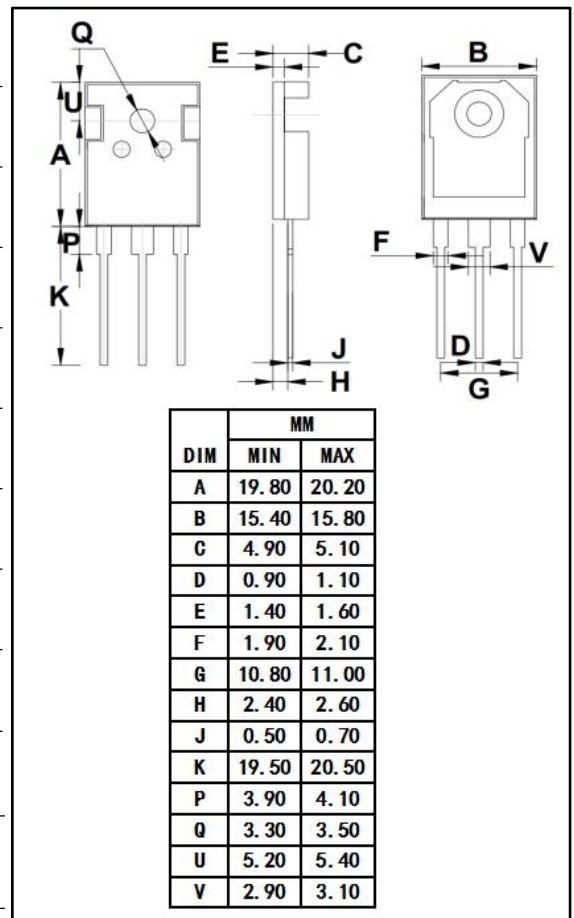
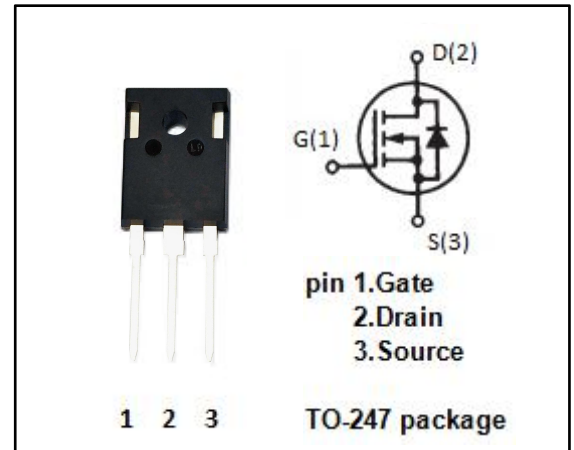

isc N-Channel MOSFET Transistor

FCH040N65S3

ELECTRICAL CHARACTERISTICS

T_c=25°C unless otherwise specified

SYMBOL	PARAMETER	CONDITIONS	MIN	TYP	MAX	UNIT
BV _{DSS}	Drain-Source Breakdown Voltage	V _{GS} =0V; I _D = 250uA	650			V
V _{GS(th)}	Gate Threshold Voltage	V _{DS} =V _{GS} ; I _D =250uA	2.5		4.5	V
R _{DS(on)}	Drain-Source On-Resistance	V _{GS} = 10V; I _D = 15A			99	mΩ
I _{GSS}	Gate-Source Leakage Current	V _{GS} =±30V;V _{DS} = 0V			±100	nA
I _{DSS}	Drain-Source Leakage Current	V _{DS} = 650V; V _{GS} = 0V			1	μA
V _{SDF}	Diode forward voltage	I _{SD} = 15A, V _{GS} = 0 V			1.2	V

NOTICE:

ISC reserves the rights to make changes of the content herein the datasheet at any time without notification. The information contained herein is presented only as a guide for the applications of our products.

ISC products are intended for usage in general electronic equipment. The products are not designed for use in equipment which require specialized quality and/or reliability, or in equipment which could have applications in hazardous environments, aerospace industry, or medical field. Please contact us if you intend our products to be used in these special applications.

ISC makes no warranty or guarantee regarding the suitability of its products for any particular purpose, nor does ISC assume any liability arising from the application or use of any products, and specifically disclaims any and all liability, including without limitation special, consequential or incidental damages.