



承 认 书

Specification for approval

CUSTOMER NAME 客户名称:

DIRECTOR 经办者:

PART NO. 料号: E6C1204RGB3UDA

PART NUMBER 品名: 1204 Side View RGB

ISSUE DATE 发件日期: 2018-05-28



客户承认签章

Customer confirm and sign

| | | |
|------------------|-------------------|--------------------|
| 检 查 TESTED BY | 核 对 CHECKED BY | 承 认 APPROVED BY |
| | | |

| | | |
|---------------------------|---------------|-----------------|
| 审 核 结 果 INSPECT RESULT | 合 格 ACCEPT | 不 合 格 REJECT |
|---------------------------|---------------|-----------------|

REMARK 说明:



Features 产品特点:

- Long operating life 使用寿命长
- Low Power Consumption 低功耗
- Wide Viewing Angle 宽视角
- RoHS Compliant 通过无铅认证



Application 适用范围:

- Backlight 背光源
- Decoration lighting 装饰光源
- motormeter 汽车仪表光源
- Indicator 指示光源

| Part Number 产品型号 | Dice Material 芯片材质 | Emitted Color 发光颜色 | Lens Color 胶体颜色 |
|---------------------|-----------------------|-----------------------|----------------------|
| E6C1204RGBC3UDA | AlGaInP-InGaN-InGaN | Red-Green-Blue | Water Clear/Diffused |

Electro-Optical Characteristics(Ta=25°C, @20mA)光电参数

| Parameter 参数 | Symbol 符号 | Min.最小值 | Typ. 中间值 | Max. 最大值 | Unit 单位 |
|-------------------------|-----------|---------|----------|----------|---------|
| Luminous Intensity 亮度 | IV | R:70 | - | 150 | mcd |
| | | G:400 | - | 600 | mcd |
| | | B:70 | - | 150 | mcd |
| Dominant Wavelength 主波长 | λd | R:617 | 620 | 630 | nm |
| | | G:520 | 525 | 530 | nm |
| | | B:460 | 465 | 475 | nm |
| Forward Voltage 电压 | VF | R:1.90 | 2.00 | 2.40 | v |
| | | G:2.80 | 3.00 | 3.40 | v |
| | | B:2.80 | 3.00 | 3.40 | v |
| Viewing Angle 发光角度 | 2θ1/2 | - | 150 | - | deg |
| Reverse Current 反向电流 | IR | - | - | 10 | uA |

Absolute Maximum Ratings(Ta=25°C)绝对最大额定值

| Parameter 参数 | Symbol 符号 | Max.最大值 | Unit 单位 |
|--|-----------|------------------|---------|
| Peak Forward Current(1/10 Duty Cycle, 0.1ms Pulse Width)峰值正向电流 (1/10 的占空比, 0.1ms 脉冲宽度) | IPF | 100 | mA |
| Forward Current 正向电流 | IF | 30 | mA |
| Reverse Voltage 反向电压 | VR | 5 | v |
| Electrostatic Discharge 抗静电能力 | ESD | 2000 | v |
| Operating Temperature Range 工作温度 | Topr | -40to+90 | °C |
| Storage Temperature Range 储存温度 | Tstg | -40to+90 | °C |
| Reflow Soldering 焊接温度 | Tsld | 260°C for 10secs | |



Optical & Electrical Characteristics 光电特性

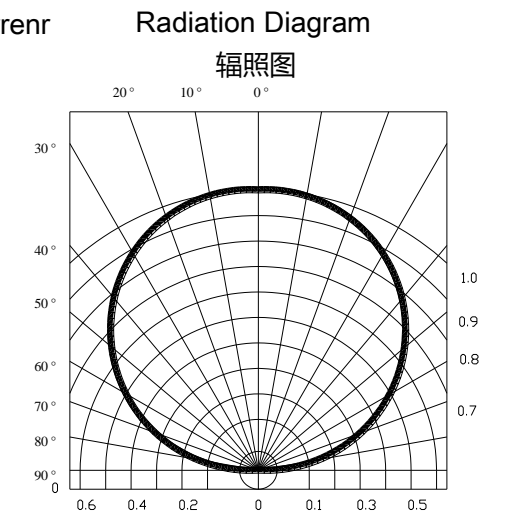
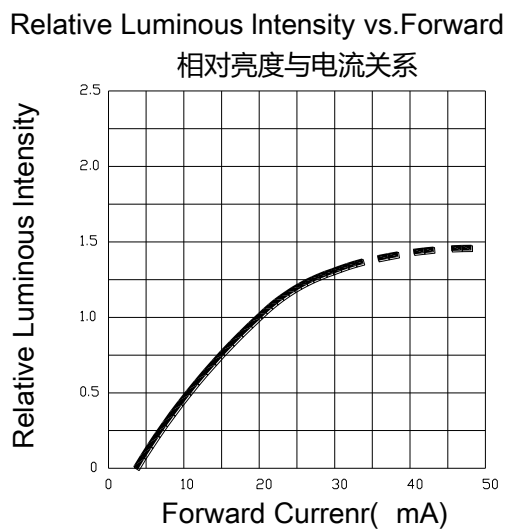
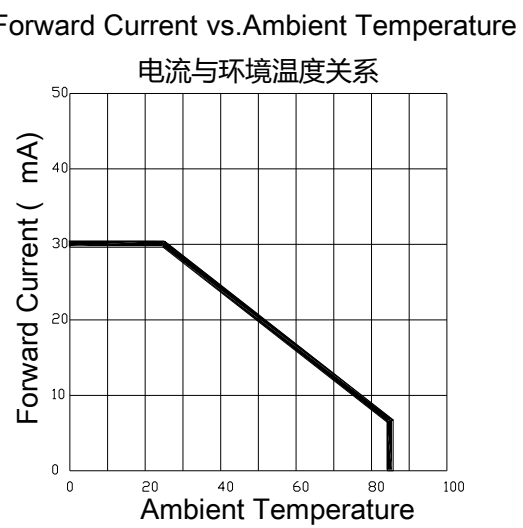
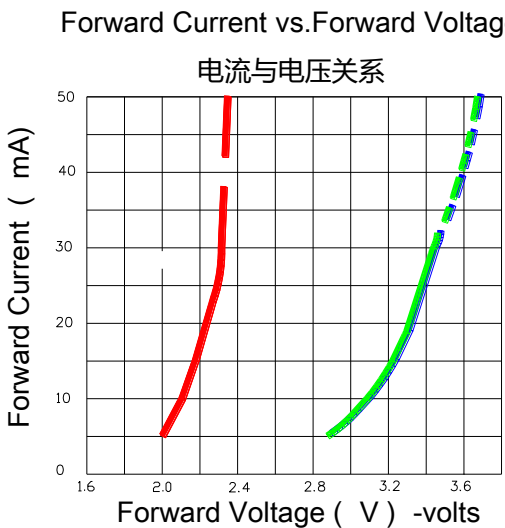
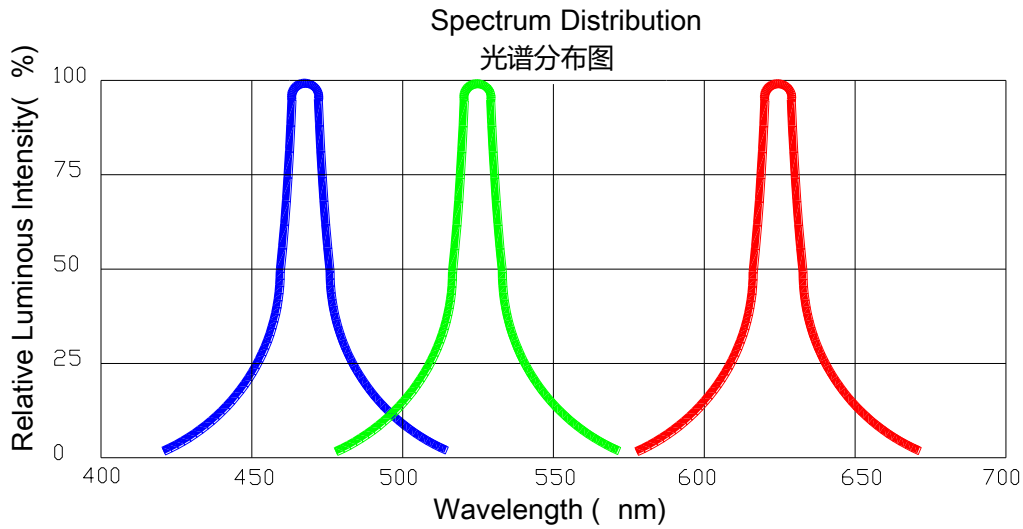



Reliability Test Items And Conditions 可靠性实验

| 实验项目 Test Items | 参考标准 Reference | 实验条件 Test Conditions | 时间 Time | 样品数 Quantity | 判据 Criterion |
|---|------------------------|---------------------------------|---------------------|-----------------|-----------------|
| 冷热冲击 Thermal Shock | MIL-STD-202G | -40°C (30min) ~100°C (30min) | 100循环 100 Cycles | 22 | 0/22 |
| 湿热循环 Temperature And Humidity Cyclic | JEITA ED-4701 200 203 | -10°C~65°C ; 0%~90%RH | 10循环 10cycles | 22 | 0/22 |
| 高温储存 High Temperature Storage | JEITA ED -4071 200 201 | Ta=100°C | 1000H | 22 | 0/22 |
| 低温储存 Low Temperature Storage | JEITA ED -4071 200 202 | Ta=-40°C | 1000H | 22 | 0/22 |
| 高温高湿储存 High Temperature High Humidity Storage | JEITA ED -4071 100 103 | Ta=60°C ; RH=90% | 1000H | 22 | 0/22 |
| 高温寿命 High Temperature Life Test | JESD22-A108D | Ta=80°C | 1000H | 22 | 0/22 |
| 常温寿命试验 Life Test | JESD22-A108D | Ta=25°C IF=20mA | 1000H | 22 | 0/22 |
| 耐热冲击性 Resistance to Soldering Heat | GB/T 4937, II, 2.2&2.3 | Tsol*=(240±5)°C 10secs | 2次 2 times | 22 | 0/22 |

Criteria For Judging Damage 失效判断标准

| 测试项目 Test Items | 符号 Symbol | 测试条件 Test Conditions | 判定标准 Criteria For Judging Damage |
|---------------------------------------|----------------|---------------------------------|---|
| 正向电压 Forward Voltage | V _F | I _F =I _{FT} | 初始值±10% Initial Data±10% |
| 反向电流 Reverse Current | I _R | V _R =5V | I _R ≤10uA |
| 光强 Luminous Intensity | I _V | I _F =I _{FT} | 平均I _V 衰减≤30% ; 单个I _V 衰减≤50% Average I _V degradation≤30% ; Single LED I _V degradation≤50% |
| 耐热冲击性 Resistance to Soldering Heat | | | 材料内部无裂痕、无材料间爆裂、剥离、无死灯 Material without internal cracks, no material between stripped, no dead light |



Product size 产品尺寸 (Unit:mm)

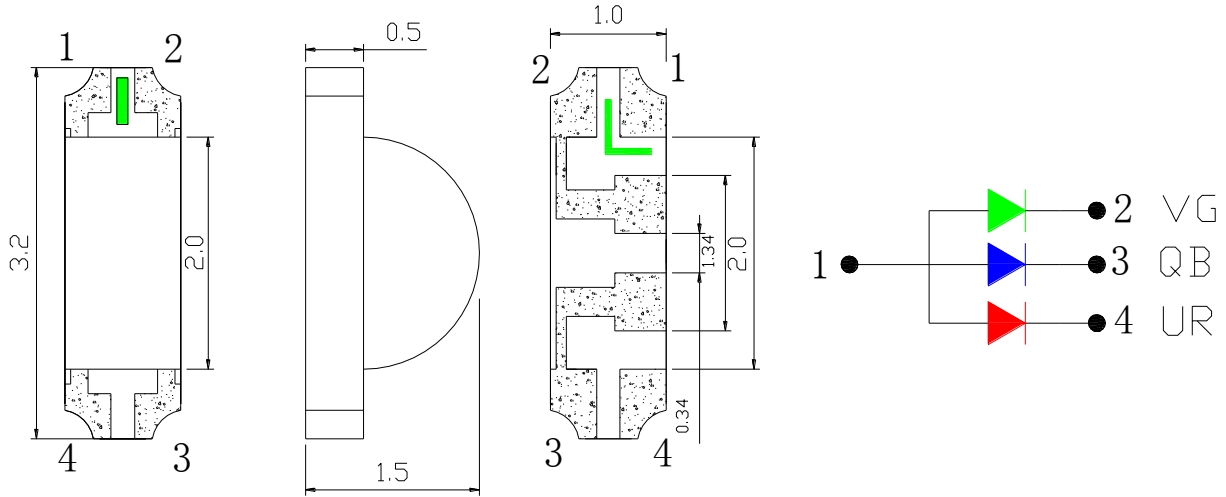

NOTES 注释:

- 1. All dimensions are in millimeters (inches)所有的尺寸均以毫米(英寸)
- 2. Tolerances are $\pm 0.2\text{mm}$ (0.008inch) unless otherwise noted。除非另有注明;公差是0.2毫米(0.008英寸)

Recommended Soldering Pad Design 推荐焊盘设计 (Unit : mm)

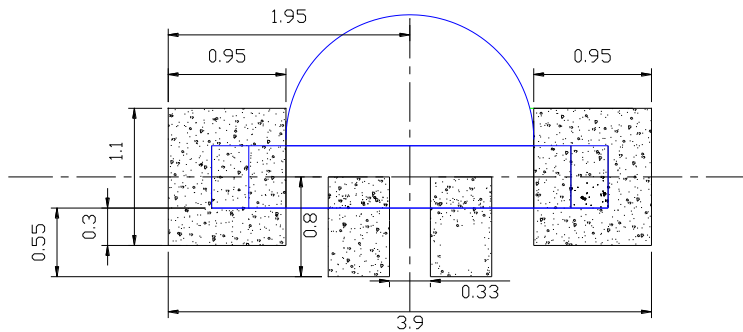

Taping and package Spec 编带和包装规格

- Tape Specification: 3,000pcs Per Reel 编带包装3000PCS/卷

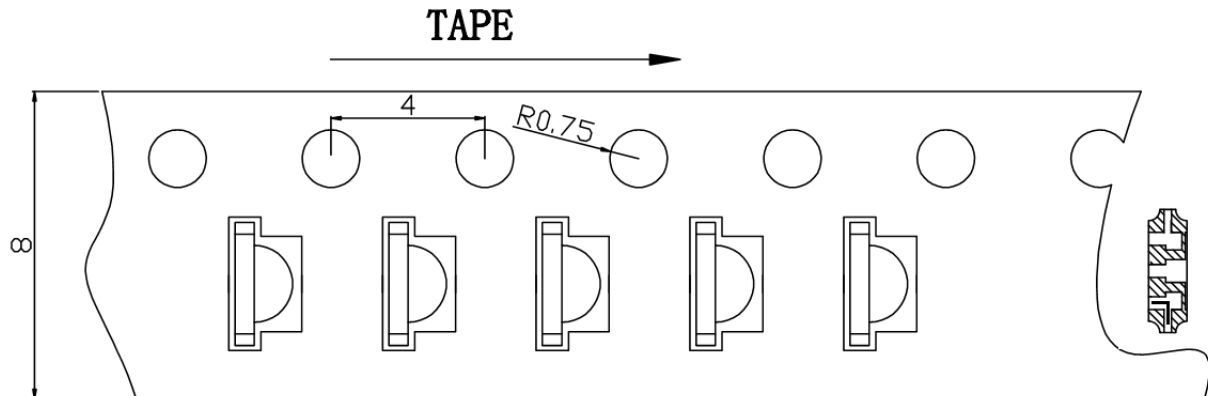



Packaging 包装规格

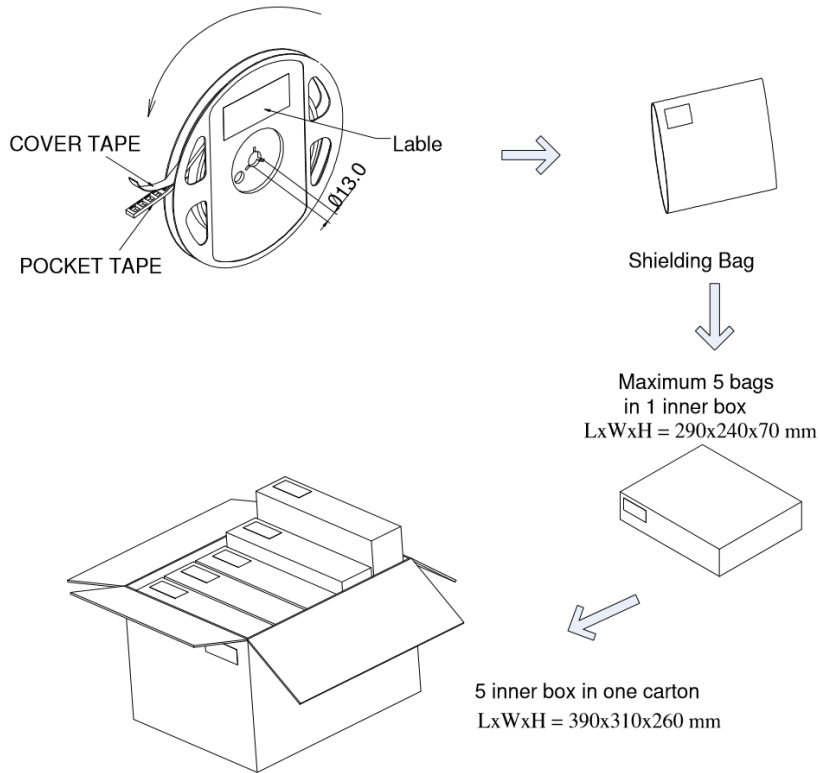

Label Style 标签样式

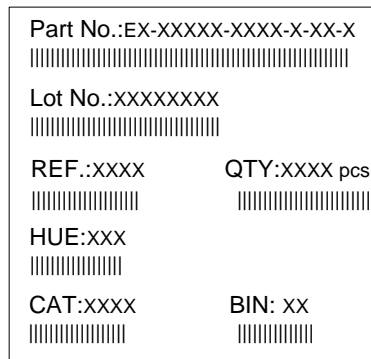

Part No:产品型号
 Lot No:生产批次
 QTY: 数量
 REF: 电压
 HUE:波长或色区
 CAT: 亮度
 BIN:分选等级



Useful hint 产品使用说明

Reflow Soldering Instructions 回流焊说明

Lead Solder 有铅回焊

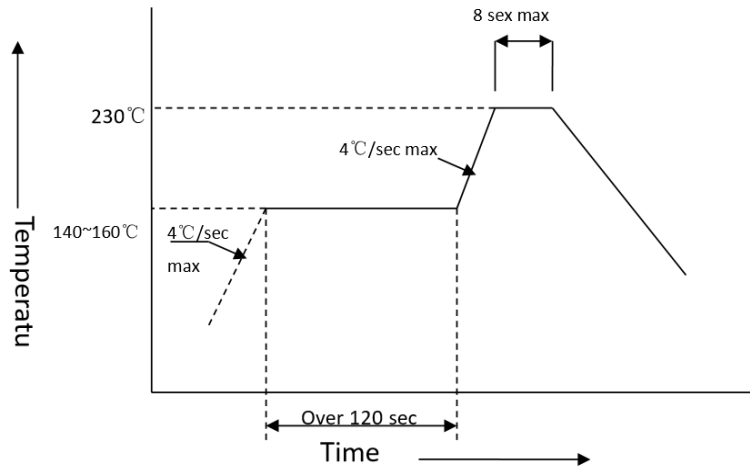

Lead-Free Solder 无铅回焊

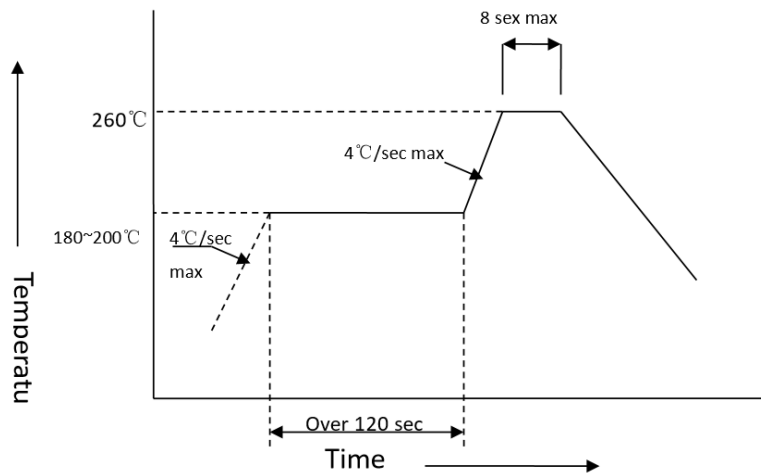

- 回流焊最多只能进行两次。

Reflow soldering should not be done more than two times

- 在回流焊升温过程中，请不要对 LED 施加任何压力。

Stress on the LEDs should be avoided during heating in soldering process

- 在焊接完成后，待产品温度下降到室温之后，再进行其它处理。

After soldering, do not deal with the product before its temperature drop down to room Temperature.



Precautions 使用注意事项

1. Storage 贮存:

- 本产品使用密封防潮防静电袋包装，并附有干燥剂，未开封的产品有一年的保存时间。

Moisture proof and anti-electrostatic package with moisture absorbent material is used, to keep moisture to a minimum.

- 开封前，产品须存放在温度不高于 30°C，湿度不高于 60%RH 的环境中。

Before opening the package, the product should be kept at 30°C or less and humidity less than 60% RH, and be used within a year.

- 开封后，产品须存放在温度不高于 30°C，湿度不高于 10%RH 的环境中，且应该在 24 小时（1 天）内使用完。建议工作环境为温度不高于 30°C，湿度不高于 60%RH。

After opening the package, the product should be stored at 30°C or less and humidity less than 10%RH, and be soldered within 24 hours (1 day). It is recommended that the product be operated at the workshop condition of 30°C or less and humidity less than 60%RH.

- 对于尚未焊接的 LED，如果吸湿剂或包装失效，或者产品没有符合以上有效存储条件，烘焙可以起到一定的性能恢复效果。烘焙条件：(70±5) °C，持续 24 小时。

If the moisture absorbent material has faded away or the LEDs have exceeded the storage time, baking treatment should be performed based on the following condition: (70±5)°C for 24 hours.

2. Static Electricity 静电:

静电和电涌会导致产品特性发生改变，例如正向电压降低等，如果情况严重甚至会损毁产品。所以在使用时必须采取有效的防静电措施。

所有相关的设备和机器都应该正确接地，同时必须采取其他防止静电和电涌的措施。

使用防静电手环，防静电垫子，防静电工作服、工作鞋、手套，防静电容器，都是有效的防止静电和电涌的措施。

Static electricity or surge voltage damages the LEDs. Damaged LEDs will show some unusual characteristics such as the forward voltage becomes lower, or the LEDs do not light at the low current, even not light.

All devices, equipment and machinery must be properly grounded. At the same time, it is recommended that wrist bands or anti-electrostatic gloves, anti-electrostatic containers be used when dealing with the LEDs.

3. Vulcanization 硫化:

LED 硫化是由于环境中的硫进入支架内部与 +1 价的银发生化学反应生成黑色 Ag_2S 的过程。该过程会导致支架镀银层的反光能力下降，色温漂移和光衰严重，很大程度上影响了产品性能。因此，在使用时应注意采取相应的防硫措施，如避免使用挥发性强的含硫物质，避免接触含硫较高的物质。

LED curing is due to sulfur being in bracket and the +1 price of silver in the chemical reaction generated Ag_2S in the process. It will lead to the capacity of reflecting of silver layer reducing, light color temperature drift and serious decline, seriously affecting the performance of the product. So we should take corresponding measures to avoid vulcanization, such as to avoid using sulphur volatile substances and keeping away from high sulphur content of the material.