



**GENERAL DESCRIPTION**

Passivated high commutation triacs in a plastic envelope intended for use in circuits where high static and dynamic dV/dt and high dI/dt can occur. These devices will commute the full rated rms current at the maximum rated junction temperature without the aid of a snubber.

**QUICK REFERENCE DATA**

SYMBOL	PARAMETER	MAX.	MAX.	MAX.	UNIT
$V_{DRM}$	Repetitive peak off-state voltages	<b>500D</b>	<b>600D</b>	<b>800D</b>	V
		<b>500C</b>	<b>600C</b>	<b>800C</b>	
$I_{T(RMS)}$	RMS on-state current	4	4	4	A
$I_{TSM}$	Non-repetitive peak on-state current	25	25	25	A

**PINNING - TO220AB**

PIN	DESCRIPTION
1	main terminal 1
2	main terminal 2
3	gate
tab	main terminal 2

**PIN CONFIGURATION**

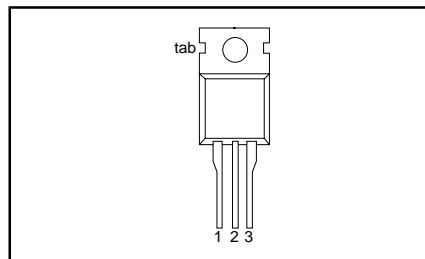

**SYMBOL**

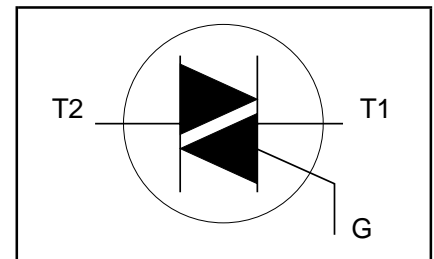

**LIMITING VALUES**

Limiting values in accordance with the Absolute Maximum System (IEC 134).

SYMBOL	PARAMETER	CONDITIONS	MIN.	MAX.			UNIT
				-500 500 <sup>1</sup>	-600 600 <sup>1</sup>	-800 800	
$V_{DRM}$	Repetitive peak off-state voltages		-				V
$I_{T(RMS)}$	RMS on-state current	full sine wave; $T_{mb} \leq 107^\circ\text{C}$	-	4			A
$I_{TSM}$	Non-repetitive peak on-state current	full sine wave; $T_j = 25^\circ\text{C}$ prior to surge	-	25			A
		$t = 20\text{ ms}$	-	27			A
		$t = 16.7\text{ ms}$	-	3.1			A <sup>2</sup> s
$I^2t$	$I^2t$ for fusing	$t = 10\text{ ms}$	-	100			A/μs
$dl_T/dt$	Repetitive rate of rise of on-state current after triggering	$I_{TM} = 6\text{ A}; I_G = 0.2\text{ A}; dl_G/dt = 0.2\text{ A}/\mu\text{s}$	-				
$I_{GM}$	Peak gate current		-	2			A
$V_{GM}$	Peak gate voltage		-	5			V
$P_{GM}$	Peak gate power		-	5			W
$P_{G(AV)}$	Average gate power	over any 20 ms period	-	0.5			W
$T_{stg}$	Storage temperature		-40	150			°C
$T_j$	Operating junction temperature		-	125			°C

<sup>1</sup> Although not recommended, off-state voltages up to 800V may be applied without damage, but the triac may switch to the on-state. The rate of rise of current should not exceed 6 A/μs.

## THERMAL RESISTANCES

SYMBOL	PARAMETER	CONDITIONS	MIN.	TYP.	MAX.	UNIT
$R_{th\ j-mb}$	Thermal resistance junction to mounting base	full cycle	-	-	3.0	K/W
$R_{th\ j-a}$	Thermal resistance junction to ambient	half cycle in free air	-	60	3.7	K/W
			-		-	K/W

## STATIC CHARACTERISTICS

$T_j = 25\text{ °C}$  unless otherwise stated

SYMBOL	PARAMETER	CONDITIONS	MIN.	TYP.	MAX.	UNIT	
		<b>BTA204-</b>			<b>...B</b>	<b>...C</b>	
$I_{GT}$	Gate trigger current <sup>2</sup>	$V_D = 12\text{ V}; I_T = 0.1\text{ A}$ T2+ G+ T2+ G- T2- G-	-	-	50	35	mA
$I_L$	Latching current	$V_D = 12\text{ V}; I_{GT} = 0.1\text{ A}$ T2+ G+ T2+ G- T2- G-	-	-	30	20	mA
$I_H$	Holding current	$V_D = 12\text{ V}; I_{GT} = 0.1\text{ A}$	-	-	45	30	mA
$V_T$	On-state voltage	$I_T = 5\text{ A}$	-	1.4	30	20	mA
$V_{GT}$	Gate trigger voltage	$V_D = 12\text{ V}; I_T = 0.1\text{ A}$ $V_D = 400\text{ V}; I_T = 0.1\text{ A};$ $T_j = 125\text{ °C}$	0.25	0.4	1.7	1.5	V
$I_D$	Off-state leakage current	$V_D = V_{DRM(max)}; T_j = 125\text{ °C}$	-	0.1	-	-	V
					0.5	0.5	mA

## DYNAMIC CHARACTERISTICS

$T_j = 25\text{ °C}$  unless otherwise stated

SYMBOL	PARAMETER	CONDITIONS	MIN.	TYP.	UNIT	
		<b>BTA204-</b>	<b>...B</b>	<b>...C</b>		
$dV_D/dt$	Critical rate of rise of off-state voltage	$V_{DM} = 67\% V_{DRM(max)}; T_j = 125\text{ °C};$ exponential waveform; gate open circuit	1000	1000	-	V/ $\mu$ s
$dI_{com}/dt$	Critical rate of change of commutating current	$V_{DM} = 400\text{ V}; T_j = 125\text{ °C}; I_{T(RMS)} = 4\text{ A};$ $dV_{com}/dt = 20\text{ V}/\mu\text{s};$ gate open circuit	6	3	-	A/ms
$t_{gt}$	Gate controlled turn-on time	$I_{TM} = 12\text{ A}; V_D = V_{DRM(max)}; I_G = 0.1\text{ A};$ $dI_G/dt = 5\text{ A}/\mu\text{s}$	-	-	2	$\mu$ s

<sup>2</sup> Device does not trigger in the T2-, G+ quadrant.

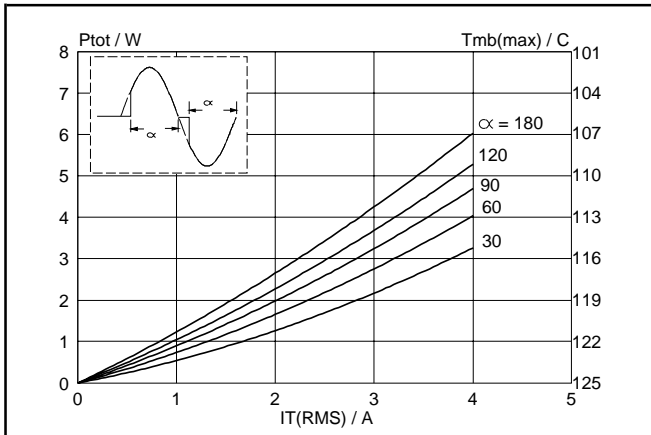

Fig. 1. Maximum on-state dissipation,  $P_{tot}$ , versus rms on-state current,  $I_{T(RMS)}$ , where  $\alpha =$  conduction angle.

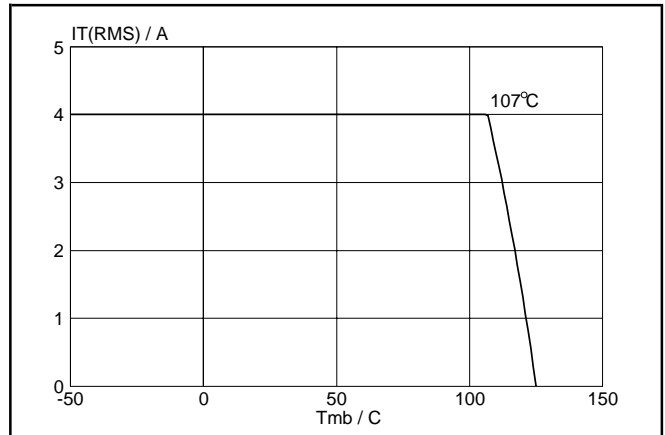

Fig. 4. Maximum permissible rms current  $I_{T(RMS)}$ , versus mounting base temperature  $T_{mb}$ .

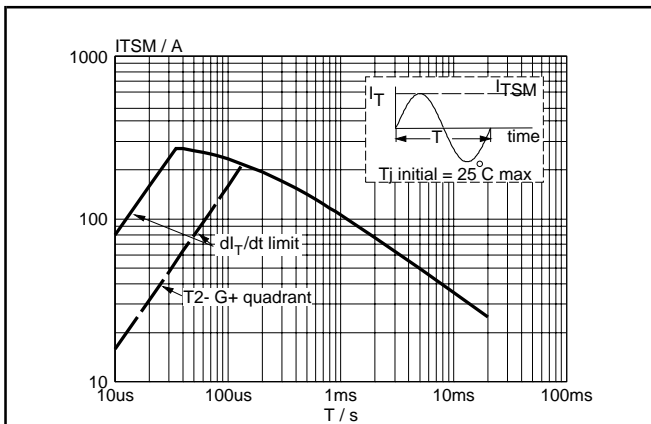

Fig. 2. Maximum permissible non-repetitive peak on-state current  $I_{TSM}$ , versus pulse width  $t_p$ , for sinusoidal currents,  $t_p \leq 20\text{ms}$ .

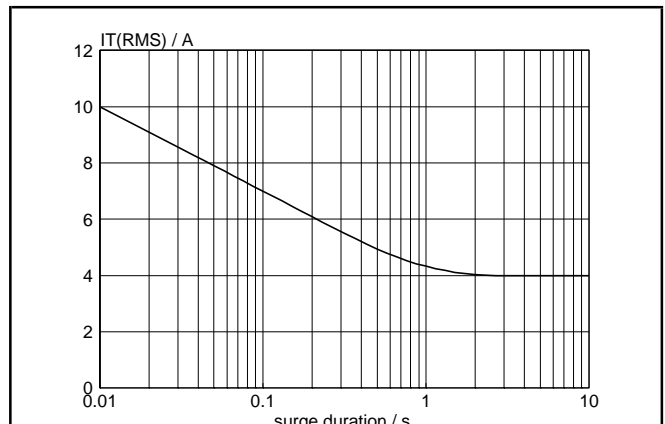

Fig. 5. Maximum permissible repetitive rms on-state current  $I_{T(RMS)}$ , versus surge duration, for sinusoidal currents,  $f = 50\text{ Hz}$ ;  $T_{mb} \leq 107^\circ\text{C}$ .

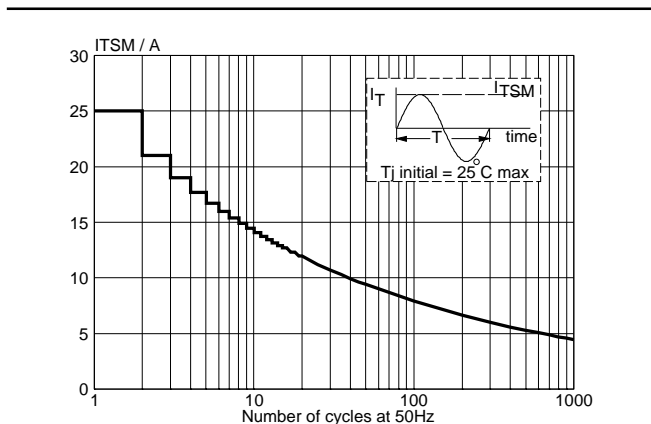

Fig. 3. Maximum permissible non-repetitive peak on-state current  $I_{TSM}$ , versus number of cycles, for sinusoidal currents,  $f = 50\text{ Hz}$ .

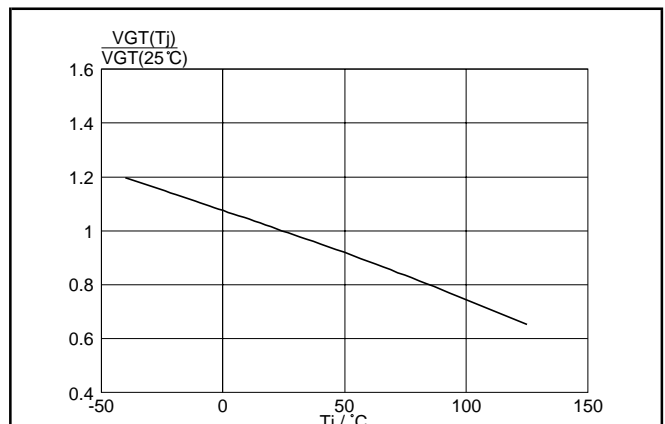
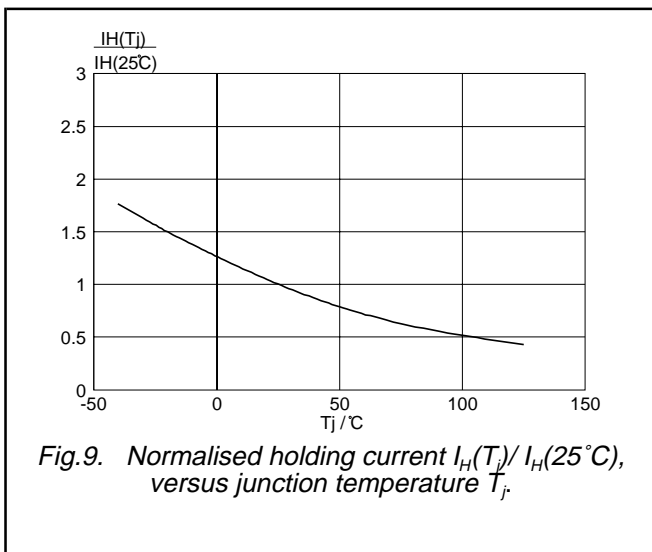
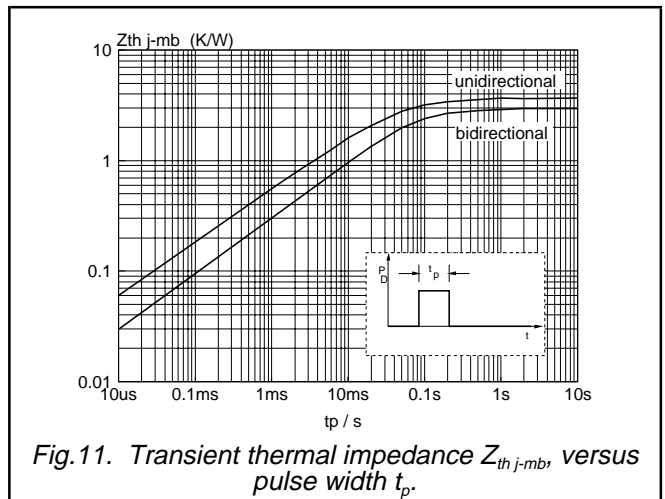
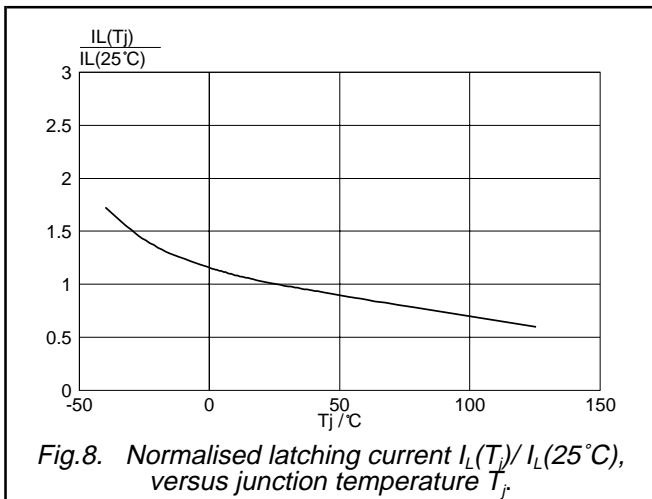
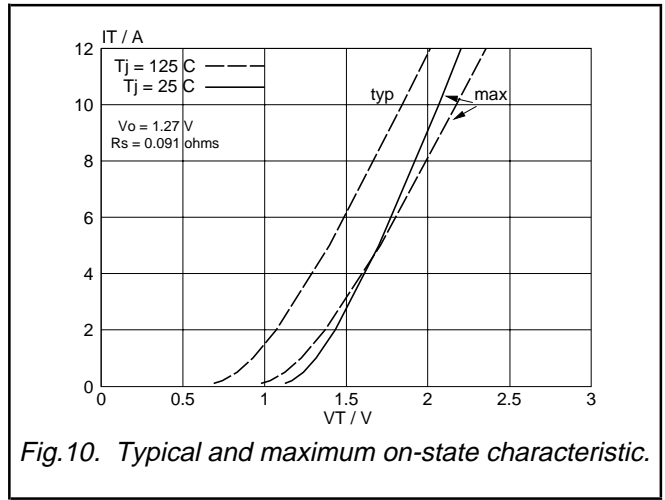
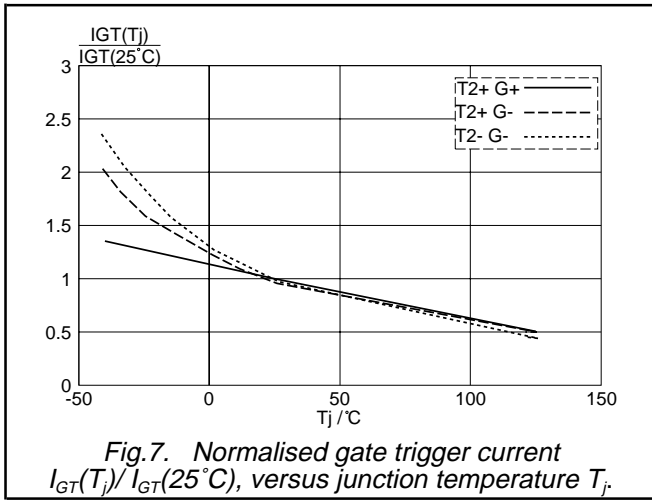

Fig. 6. Normalised gate trigger voltage  $V_{GT}(T_j) / V_{GT}(25^\circ\text{C})$ , versus junction temperature  $T_j$ .



## MECHANICAL DATA

Dimensions in mm

Net Mass: 2 g

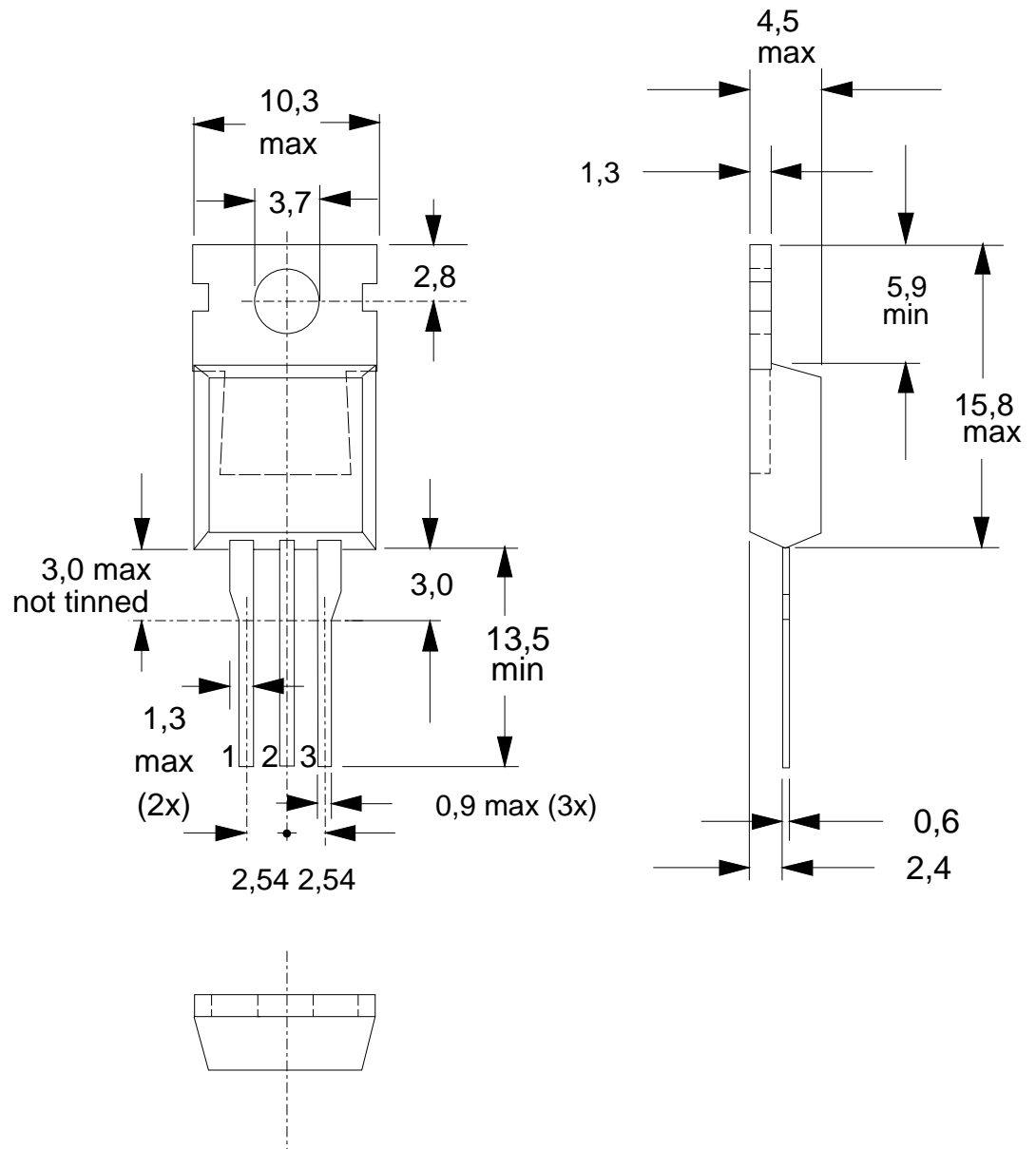

Fig.12. SOT78 (TO220AB). pin 2 connected to mounting base.

### Notes

1. Refer to mounting instructions for SOT78 (TO220) envelopes.
2. Epoxy meets UL94 V0 at 1/8".