



# SGM8746

## 155ns, Low-Power, 3V/5V, Rail-to-Rail Input Single-Supply Comparator

---

### GENERAL DESCRIPTION

The SGM8746 is a single, rail-to-rail input, single-supply comparator with typical 22 $\mu$ A power supply current. The comparator operates from a wide range of 2.7V to 5.5V supply voltage and features high-speed response, and rail-to-rail input range.

The SGM8746 is optimized for low-power, single-supply operation with greater than rail-to-rail input operation. The output stage pulls to within 0.1V of either supply rail without external pull-up circuitry, and interfaces with CMOS/TTL logic. All input and output pins have a continuous short-circuit protection to each rail.

The SGM8746 is available in Green SOT-23-5 and SC70-5 packages. It is rated over the -40°C to +85°C temperature range.

### FEATURES

- **Fast Propagation Delay:**  
155ns (TYP) at 10mV Overdrive
- **Low Quiescent Current:**  
22 $\mu$ A (TYP) at  $V_S = 3V$
- **Wide Single-Supply Voltage Range: 2.7V to 5.5V**
- **Optimized for 3V/5V Applications**
- **Rail-to-Rail Input**
- **Low Offset Voltage: 0.8mV (TYP)**
- **Output Swing to within 190mV from Rails with 4mA Output Current**
- **CMOS/TTL-Compatible Output**
- **Internal Hysteresis for Clean Switching**
- **-40°C to +85°C Operating Temperature Range**
- **Available in Green SOT-23-5 and SC70-5 Packages**

### APPLICATIONS

Portable and Battery-Powered Applications  
3V/5V Systems  
Threshold Detectors  
Line Receivers



**ELECTRICAL CHARACTERISTICS**(V<sub>S</sub> = 5.0V, V<sub>CM</sub> = 0V, C<sub>L</sub> = 15pF, typical values are at T<sub>A</sub> = +25°C, unless otherwise noted.)

PARAMETER	SYMBOL	CONDITIONS	MIN	TYP	MAX	UNITS
Operating Supply Voltage	V <sub>S</sub>		2.7		5.5	V
Input Common Mode Voltage Range	V <sub>CM</sub>		-0.1		V <sub>S</sub> + 0.1	V
Input Offset Voltage	V <sub>OS</sub>	V <sub>S</sub> = 5V, V <sub>CM</sub> = 0V		0.8	4.9	mV
		-40°C ≤ T <sub>A</sub> ≤ +85°C			5.8	
Input Hysteresis	V <sub>HYST</sub>	V <sub>S</sub> = 5V, V <sub>CM</sub> = 0V		2.5		mV
Output Short-Circuit Current	I <sub>SOURCE</sub>	V <sub>S</sub> = 5V, Out to V <sub>S</sub> /2	22.5	34		mA
		-40°C ≤ T <sub>A</sub> ≤ +85°C	19			
	I <sub>SINK</sub>	V <sub>S</sub> = 5V, Out to V <sub>S</sub> /2		-33	-25.5	
		-40°C ≤ T <sub>A</sub> ≤ +85°C			-21	
Common Mode Rejection Ratio	CMRR	V <sub>S</sub> = 5V, V <sub>CM</sub> = 0V to 5V	59	78		dB
		-40°C ≤ T <sub>A</sub> ≤ +85°C	54			
Power Supply Rejection Ratio	PSRR	V <sub>CM</sub> = 0V, V <sub>S</sub> = 2.7V to 5.5V	58	71		dB
		-40°C ≤ T <sub>A</sub> ≤ +85°C	54			
Output Voltage Swing from Rail	V <sub>OH</sub>	V <sub>S</sub> = 5V, I <sub>OUT</sub> = 4mA		188	275	mV
		-40°C ≤ T <sub>A</sub> ≤ +85°C			305	
	V <sub>OL</sub>	V <sub>S</sub> = 5V, I <sub>OUT</sub> = -4mA		179	222	
		-40°C ≤ T <sub>A</sub> ≤ +85°C			248	
Supply Current	I <sub>S</sub>	V <sub>S</sub> = 3V, I <sub>OUT</sub> = 0		22	32	μA
		-40°C ≤ T <sub>A</sub> ≤ +85°C			40	
		V <sub>S</sub> = 5V, I <sub>OUT</sub> = 0		25	39	
		-40°C ≤ T <sub>A</sub> ≤ +85°C			52	
Propagation Delay (High to Low)		V <sub>S</sub> = 3V, Overdrive = 10mV		155		ns
		V <sub>S</sub> = 3V, Overdrive = 100mV		95		
Propagation Delay (Low to High)		V <sub>S</sub> = 3V, Overdrive = 10mV		145		ns
		V <sub>S</sub> = 3V, Overdrive = 100mV		120		
Rise Time	t <sub>RISE</sub>	V <sub>S</sub> = 3V, Overdrive = 10mV		10		ns
		V <sub>S</sub> = 3V, Overdrive = 100mV		8		
Fall Time	t <sub>FALL</sub>	V <sub>S</sub> = 3V, Overdrive = 10mV		8		ns
		V <sub>S</sub> = 3V, Overdrive = 100mV		6		

TYPICAL PERFORMANCE CHARACTERISTICS

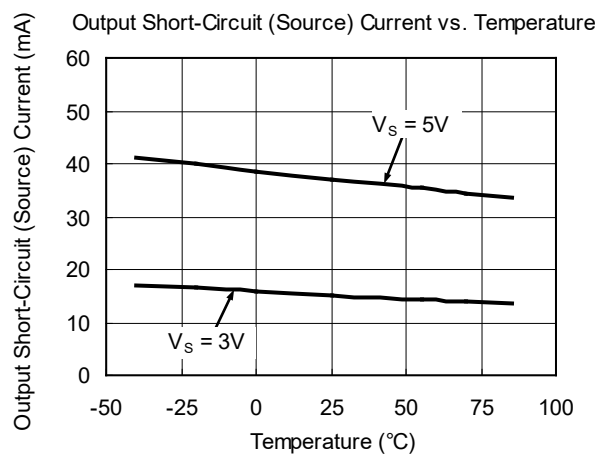
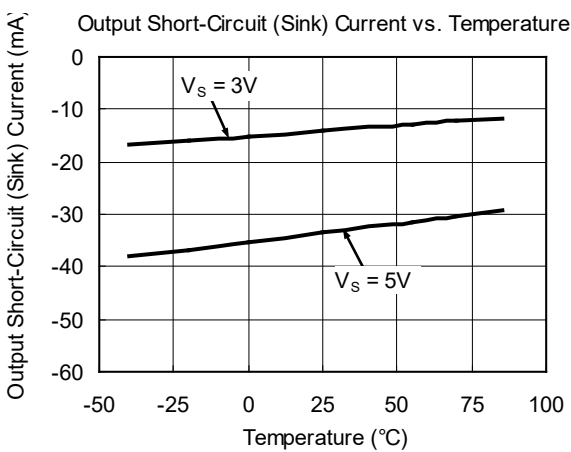
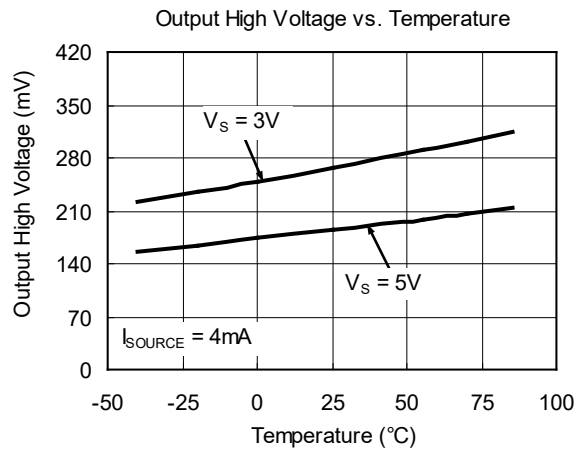
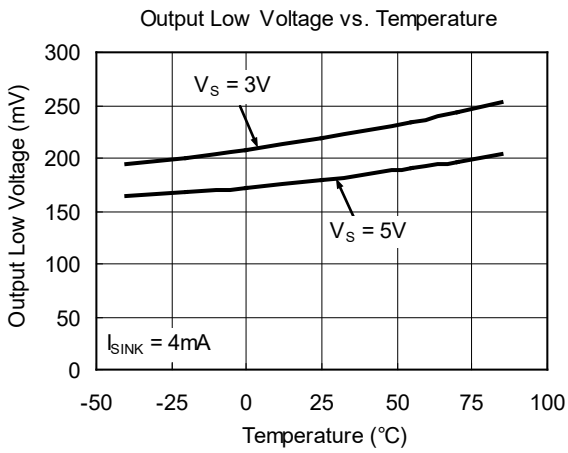
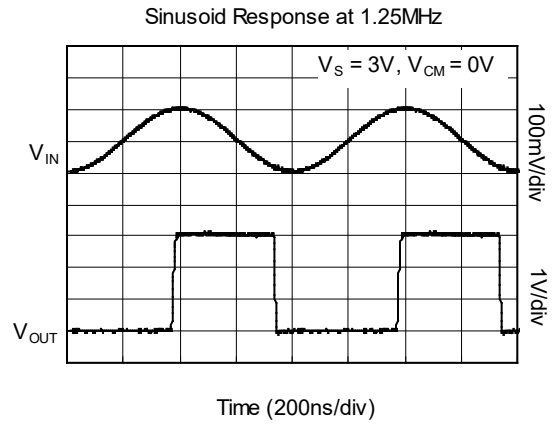
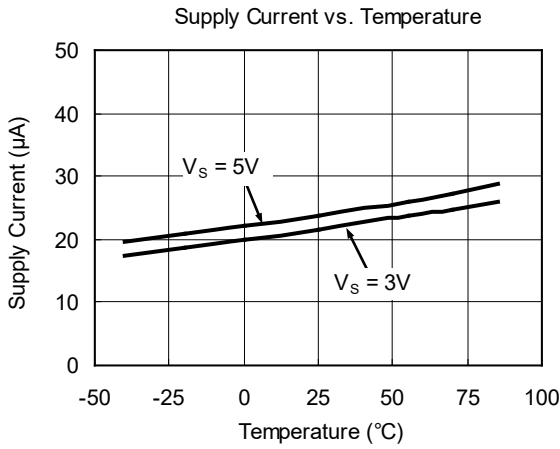

TYPICAL PERFORMANCE CHARACTERISTICS (continued)

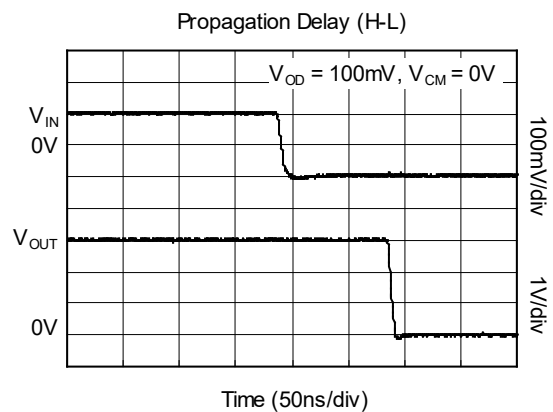
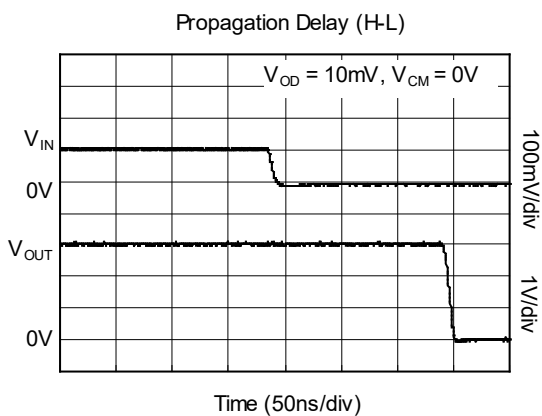
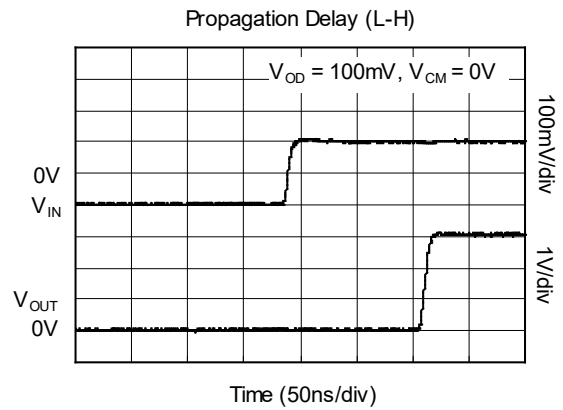
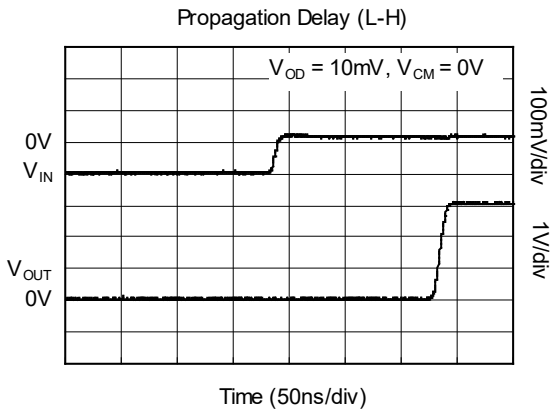
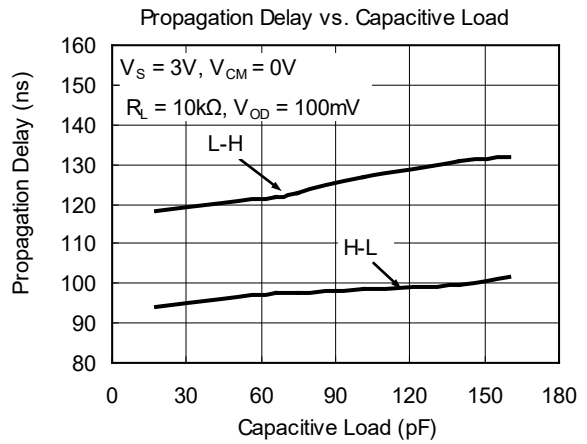
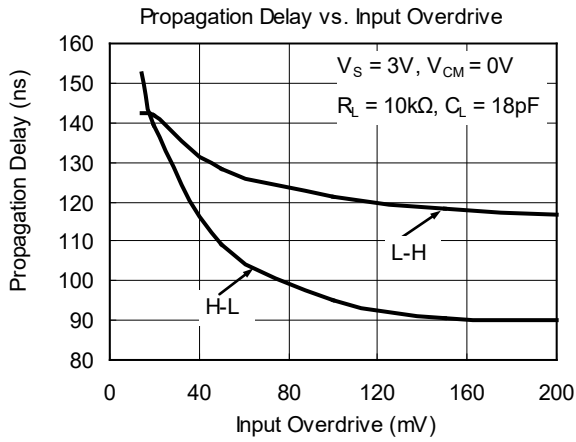

**TYPICAL PERFORMANCE CHARACTERISTICS (continued)**

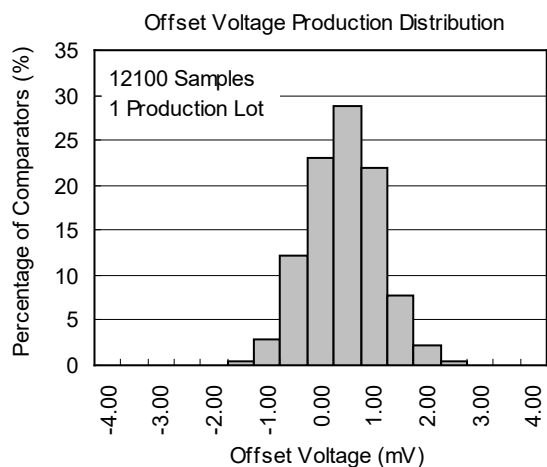

**REVISION HISTORY**

NOTE: Page numbers for previous revisions may differ from page numbers in the current version.

Changes from Original (NOVEMBER 2014) to REV.A	Page
Changed from product preview to production data.....	All

PACKAGE OUTLINE DIMENSIONS

SOT-23-5

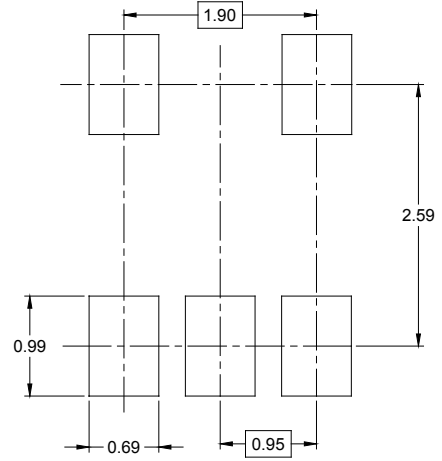
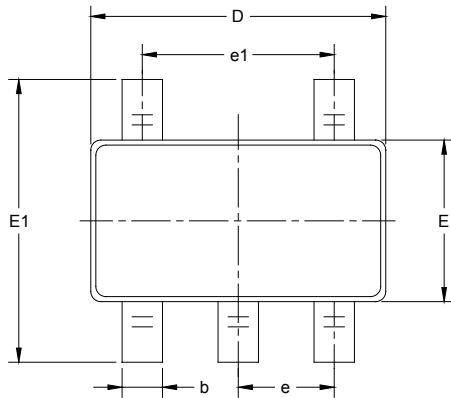

RECOMMENDED LAND PATTERN (Unit: mm)

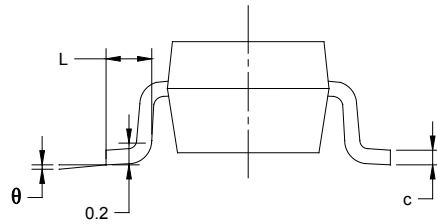
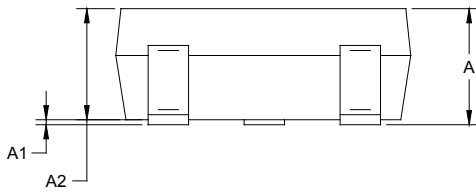

Symbol	Dimensions In Millimeters		Dimensions In Inches	
	MIN	MAX	MIN	MAX
A	1.050	1.250	0.041	0.049
A1	0.000	0.100	0.000	0.004
A2	1.050	1.150	0.041	0.045
b	0.300	0.500	0.012	0.020
c	0.100	0.200	0.004	0.008
D	2.820	3.020	0.111	0.119
E	1.500	1.700	0.059	0.067
E1	2.650	2.950	0.104	0.116
e	0.950 BSC		0.037 BSC	
e1	1.900 BSC		0.075 BSC	
L	0.300	0.600	0.012	0.024
$\theta$	0°	8°	0°	8°

PACKAGE OUTLINE DIMENSIONS

SC70-5

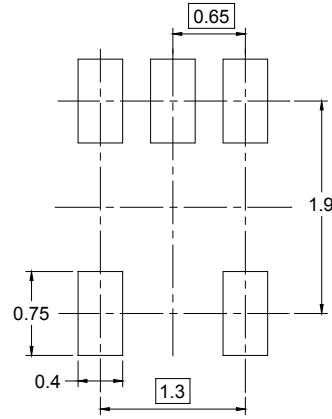
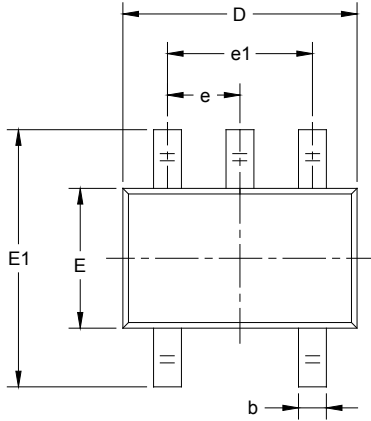

RECOMMENDED LAND PATTERN (Unit: mm)

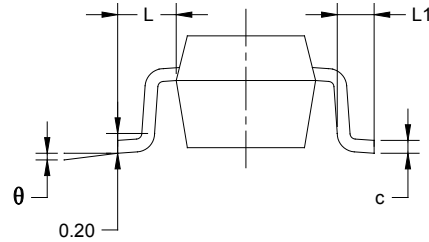
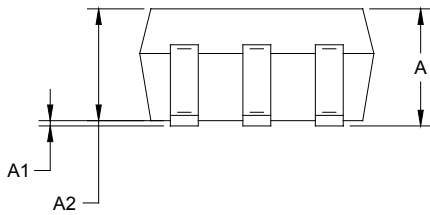

Symbol	Dimensions In Millimeters		Dimensions In Inches	
	MIN	MAX	MIN	MAX
A	0.900	1.100	0.035	0.043
A1	0.000	0.100	0.000	0.004
A2	0.900	1.000	0.035	0.039
b	0.150	0.350	0.006	0.014
c	0.080	0.150	0.003	0.006
D	2.000	2.200	0.079	0.087
E	1.150	1.350	0.045	0.053
E1	2.150	2.450	0.085	0.096
e	0.65 TYP		0.026 TYP	
e1	1.300 BSC		0.051 BSC	
L	0.525 REF		0.021 REF	
L1	0.260	0.460	0.010	0.018
$\theta$	0°	8°	0°	8°



## TAPE AND REEL INFORMATION

### REEL DIMENSIONS

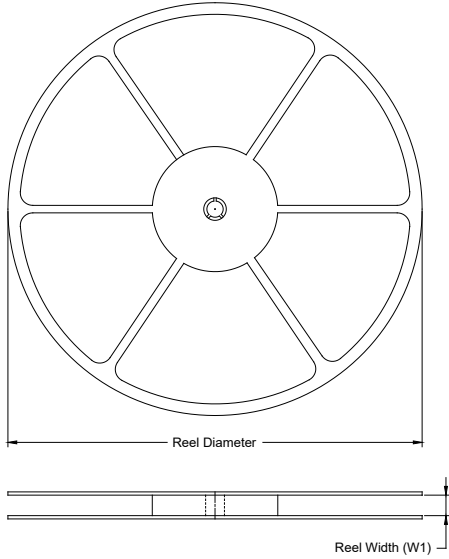

### TAPE DIMENSIONS



NOTE: The picture is only for reference. Please make the object as the standard.

### KEY PARAMETER LIST OF TAPE AND REEL

Package Type	Reel Diameter	Reel Width W1 (mm)	A0 (mm)	B0 (mm)	K0 (mm)	P0 (mm)	P1 (mm)	P2 (mm)	W (mm)	Pin1 Quadrant
SOT-23-5	7"	9.5	3.20	3.20	1.40	4.0	4.0	2.0	8.0	Q3
SC70-5	7"	9.5	2.25	2.55	1.20	4.0	4.0	2.0	8.0	Q3

D00001

# PACKAGE INFORMATION

## CARTON BOX DIMENSIONS



NOTE: The picture is only for reference. Please make the object as the standard.

## KEY PARAMETER LIST OF CARTON BOX

Reel Type	Length (mm)	Width (mm)	Height (mm)	Pizza/Carton
7" (Option)	368	227	224	8
7"	442	410	224	18

DD0002