

GENERAL DESCRIPTION

The SGM6032 is a high-efficient step-down switching voltage regulator, providing 600mA output current and fixed output voltage. This device is capable to provide an input voltage supply range of 2.5V to 5.5V. The 6MHz fixed frequency operation allows the use of a 470nH output inductor and a 4.7μF output capacitor.

The SGM6032 also can work in power-save mode under moderate and light load conditions through pulse frequency modulation (PFM). The 22μA typical quiescent current and the power-save mode can further improve the system efficiency which can reach a maximum of 90%. It also has the excellent load transient response capability. The SGM6032 also includes the features of internal soft-start, input under-voltage lockout, thermal shutdown and overload protection.

The SGM6032 is available in Green TDFN-2×2-6L and WLCSP-1.21×0.81-6B packages. It operates over an ambient temperature range of -40°C to +85°C.

FEATURES

- 2.5V to 5.5V Input Voltage Range
- 600mA Output Current Capability
- 22μA Typical Quiescent Current
- 6MHz Fixed Frequency Operation
- Excellent Efficiency and Load Transient Response
- Output Voltages: 0.6V, 0.8V, 1.0V, 1.1V, 1.15V, 1.2V, 1.5V, 1.6V, 1.8V, 2.5V, 2.8V, 3.0V and 3.3V
- Low Ripple Light-Load PFM Mode
- Internal Soft-Start
- Input Under-Voltage Lockout (UVLO)
- Thermal Shutdown
- Overload Protection
- Output Discharge
- Available in Green TDFN-2×2-6L and WLCSP-1.21×0.81-6B Packages
- -40°C to +85°C Operating Temperature Range

APPLICATIONS

Digital Cameras
 4G, WiFi, WiMAsX, and WiBro Data Cards
 Tablet Computers
 Netbooks, Ultra-Mobile PCs

TYPICAL APPLICATION

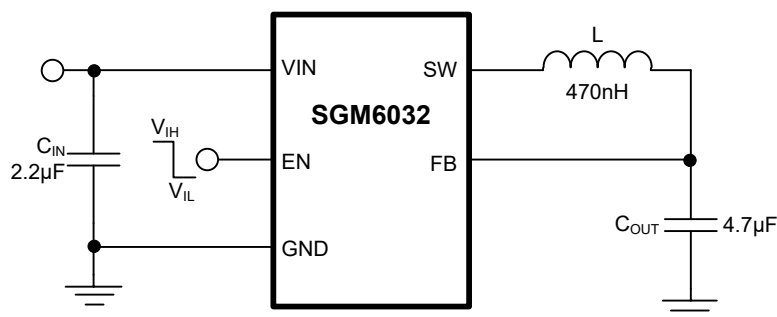

Figure 1. Typical Application Circuit

PACKAGE/ORDERING INFORMATION

MODEL	V _{OUT} (V)	PACKAGE DESCRIPTION	SPECIFIED TEMPERATURE RANGE	ORDERING NUMBER	PACKAGE MARKING	PACKING OPTION
SGM6032-0.6	0.6	TDFN-2×2-6L	-40°C to +85°C	SGM6032-0.6YTDI6G/TR	GKD XXXX	Tape and Reel, 3000
SGM6032-0.8	0.8	TDFN-2×2-6L	-40°C to +85°C	SGM6032-0.8YTDI6G/TR	MD2 XXXX	Tape and Reel, 3000
SGM6032-1.0	1.0	TDFN-2×2-6L	-40°C to +85°C	SGM6032-1.0YTDI6G/TR	MD4 XXXX	Tape and Reel, 3000
SGM6032-1.1	1.1	TDFN-2×2-6L	-40°C to +85°C	SGM6032-1.1YTDI6G/TR	GJ1 XXXX	Tape and Reel, 3000
SGM6032-1.15	1.15	TDFN-2×2-6L	-40°C to +85°C	SGM6032-1.15YTDI6G/TR	MD5 XXXX	Tape and Reel, 3000
SGM6032-1.2	1.2	TDFN-2×2-6L	-40°C to +85°C	SGM6032-1.2YTDI6G/TR	GL7 XXXX	Tape and Reel, 3000
SGM6032-1.5	1.5	TDFN-2×2-6L	-40°C to +85°C	SGM6032-1.5YTDI6G/TR	GKF XXXX	Tape and Reel, 3000
SGM6032-1.6	1.6	TDFN-2×2-6L	-40°C to +85°C	SGM6032-1.6YTDI6G/TR	M30 XXXX	Tape and Reel, 3000
SGM6032-1.8	1.8	TDFN-2×2-6L	-40°C to +85°C	SGM6032-1.8YTDI6G/TR	GJ5 XXXX	Tape and Reel, 3000
SGM6032-2.5	2.5	TDFN-2×2-6L	-40°C to +85°C	SGM6032-2.5YTDI6G/TR	GL2 XXXX	Tape and Reel, 3000
SGM6032-2.8	2.8	TDFN-2×2-6L	-40°C to +85°C	SGM6032-2.8YTDI6G/TR	GJ7 XXXX	Tape and Reel, 3000
SGM6032-3.0	3.0	TDFN-2×2-6L	-40°C to +85°C	SGM6032-3.0YTDI6G/TR	GL4 XXXX	Tape and Reel, 3000
SGM6032-3.3	3.3	TDFN-2×2-6L	-40°C to +85°C	SGM6032-3.3YTDI6G/TR	GL6 XXXX	Tape and Reel, 3000
SGM6032-0.6	0.6	WLCSP-1.21×0.81-6B	-40°C to +85°C	SGM6032-0.6YG/TR	KCXX	Tape and Reel, 3000
SGM6032-0.8	0.8	WLCSP-1.21×0.81-6B	-40°C to +85°C	SGM6032-0.8YG/TR	D3XX	Tape and Reel, 3000
SGM6032-1.0	1.0	WLCSP-1.21×0.81-6B	-40°C to +85°C	SGM6032-1.0YG/TR	W4XX	Tape and Reel, 3000
SGM6032-1.1	1.1	WLCSP-1.21×0.81-6B	-40°C to +85°C	SGM6032-1.1YG/TR	IFXX	Tape and Reel, 3000
SGM6032-1.15	1.15	WLCSP-1.21×0.81-6B	-40°C to +85°C	SGM6032-1.15YG/TR	W5XX	Tape and Reel, 3000
SGM6032-1.2	1.2	WLCSP-1.21×0.81-6B	-40°C to +85°C	SGM6032-1.2YG/TR	L0XX	Tape and Reel, 3000
SGM6032-1.5	1.5	WLCSP-1.21×0.81-6B	-40°C to +85°C	SGM6032-1.5YG/TR	KEXX	Tape and Reel, 3000
SGM6032-1.6	1.6	WLCSP-1.21×0.81-6B	-40°C to +85°C	SGM6032-1.6YG/TR	31XX	Tape and Reel, 3000
SGM6032-1.8	1.8	WLCSP-1.21×0.81-6B	-40°C to +85°C	SGM6032-1.8YG/TR	L8XX	Tape and Reel, 3000
SGM6032-2.5	2.5	WLCSP-1.21×0.81-6B	-40°C to +85°C	SGM6032-2.5YG/TR	L1XX	Tape and Reel, 3000
SGM6032-2.8	2.8	WLCSP-1.21×0.81-6B	-40°C to +85°C	SGM6032-2.8YG/TR	J6XX	Tape and Reel, 3000
SGM6032-3.0	3.0	WLCSP-1.21×0.81-6B	-40°C to +85°C	SGM6032-3.0YG/TR	L3XX	Tape and Reel, 3000
SGM6032-3.3	3.3	WLCSP-1.21×0.81-6B	-40°C to +85°C	SGM6032-3.3YG/TR	L5XX	Tape and Reel, 3000

MARKING INFORMATION

NOTE: XXXX = Date Code. XX = Date Code.

TDFN-2x2-6L

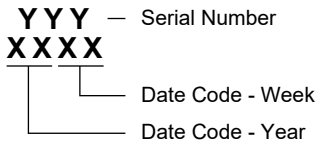

WLCSP-1.21x0.81-6B

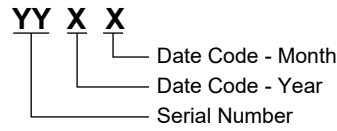

Green (RoHS & HSF): SG Micro Corp defines "Green" to mean Pb-Free (RoHS compatible) and free of halogen substances. If you have additional comments or questions, please contact your SGMICRO representative directly.

ABSOLUTE MAXIMUM RATINGS

Input Voltage.....	-0.3V to 6.5V
Voltage on SW and EN.....	-0.3V to $V_{IN} + 0.3V^{(1)}$
Package Thermal Resistance	
TDFN-2x2-6L, θ_{JA}	120°C/W
WLCSP-1.21x0.81-6B, θ_{JA}	150°C/W
Junction Temperature.....	+150°C
Storage Temperature Range.....	-65°C to +150°C
Lead Temperature (Soldering, 10s).....	+260°C
ESD Susceptibility	
HBM.....	4000V
MM.....	400V
CDM.....	1000V

NOTE: 1. Lesser of 6.5V or $V_{IN} + 0.3V$.

RECOMMENDED OPERATING CONDITIONS

Inductor, L.....	470nH
Input Capacitor, C_{IN}	2.2µF
Output Capacitor, C_{OUT}	4.7µF
Supply Voltage Range.....	2.5V to 5.5V
Operating Temperature Range.....	-40°C to +85°C

OVERSTRESS CAUTION

Stresses beyond those listed in Absolute Maximum Ratings may cause permanent damage to the device. Exposure to absolute maximum rating conditions for extended periods may affect reliability. Functional operation of the device at any conditions beyond those indicated in the Recommended Operating Conditions section is not implied.

ESD SENSITIVITY CAUTION

This integrated circuit can be damaged by ESD if you don't pay attention to ESD protection. SGMICRO recommends that all integrated circuits be handled with appropriate precautions. Failure to observe proper handling and installation procedures can cause damage. ESD damage can range from subtle performance degradation to complete device failure. Precision integrated circuits may be more susceptible to damage because very small parametric changes could cause the device not to meet its published specifications.

DISCLAIMER

SG Micro Corp reserves the right to make any change in circuit design, or specifications without prior notice.

PIN CONFIGURATIONS

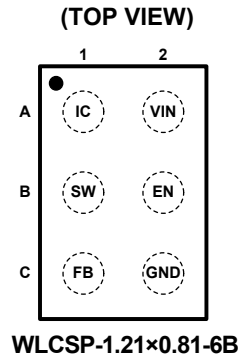
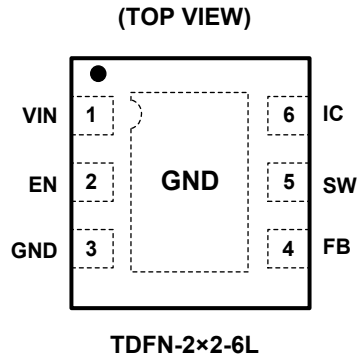

PIN DESCRIPTION

PIN		NAME	FUNCTION
TDFN-2x2-6L	WLCSP-1.21x0.81-6B		
1	A2	VIN	Input Voltage. Connect to input power source.
2	B2	EN	Forcing this pin above 1.5V enables the device. Forcing this pin below 0.3V shuts down the device. In shutdown, all functions are disabled, drawing less than 1µA supply current. Do not leave EN floating.
3	C2	GND	Ground. Power and IC ground. All signals are referenced to this pin.
4	C1	FB	Feedback/V _{OUT} . Connect to output voltage.
5	B1	SW	Switching Node. Connect to output inductor.
6	A1	IC	For Internal Connection.
Exposed Pad	–	GND	Connect to GND.

ELECTRICAL CHARACTERISTICS

(Minimum and maximum values are at $V_{IN} = V_{EN} = 2.5V$ to $5.5V$, Full = $-40^{\circ}C$ to $+85^{\circ}C$; typical values are at $V_{IN} = V_{EN} = 3.6V$, $T_A = +25^{\circ}C$, unless otherwise noted.)

PARAMETER	SYMBOL	CONDITIONS	TEMP	MIN	TYP	MAX	UNITS
POWER SUPPLIES							
Input Voltage Range	V_{IN}		Full	2.5		5.5	V
Quiescent Current	I_Q	No Load, Not Switching	Full		22	40	μA
Shutdown Supply Current	I_{SD}	EN = GND	+25°C		0.45	1	μA
Under-Voltage Lockout Threshold	V_{UVLO}	Rising V_{IN}	+25°C		2.15	2.42	V
Under-Voltage Lockout Hysteresis	V_{UVHYS}		+25°C		150		mV
EN LOGIC INPUT							
Enable High-Level Input Voltage	V_{IH}		Full	1.5			V
Enable Low-Level Input Voltage	V_{IL}		Full			0.3	V
SWITCHING							
Switching Frequency	f_{SW}	$V_{IN} = 3.6V$	+25°C	5.5	6	6.5	MHz
OUTPUT							
Output Voltage	V_{OUT}	SGM6032-1.0	Full	0.980	1.000	1.043	V
		SGM6032-1.1	Full	1.055	1.100	1.124	
		SGM6032-1.15	Full	1.121	1.150	1.190	
		SGM6032-1.2	Full	1.148	1.200	1.226	
		SGM6032-1.5	Full	1.433	1.500	1.532	
		SGM6032-1.6	Full	1.543	1.600	1.641	
		SGM6032-1.8	Full	1.726	1.800	1.841	
		SGM6032-2.5	Full	2.378	2.500	2.527	
		SGM6032-2.8	Full	2.680	2.800	2.849	
SGM6032-3.0	Full	2.846	3.000	3.031			
Soft-Start	t_{SS}	From EN Rising Edge	+25°C		200		μs
OUTPUT DRIVER							
PMOS On-Resistance	$R_{DS(ON)}$	$V_{IN} = V_{GS} = 3.6V$	+25°C		350		m Ω
NMOS On-Resistance		$V_{IN} = V_{GS} = 3.6V$	+25°C		250		m Ω
PMOS Peak Current Limit	$I_{LIM(OL)}$		+25°C	1630	1900	2130	mA
Output Discharge Resistance	R_{DIS}	EN = GND	+25°C		230		Ω
Thermal Shutdown	T_{TSD}				160		°C
Thermal Shutdown Hysteresis	T_{HYS}				15		°C

TYPICAL PERFORMANCE CHARACTERISTICS

T_A = +25°C, V_{IN} = V_{EN} = 3.6V, unless otherwise noted.

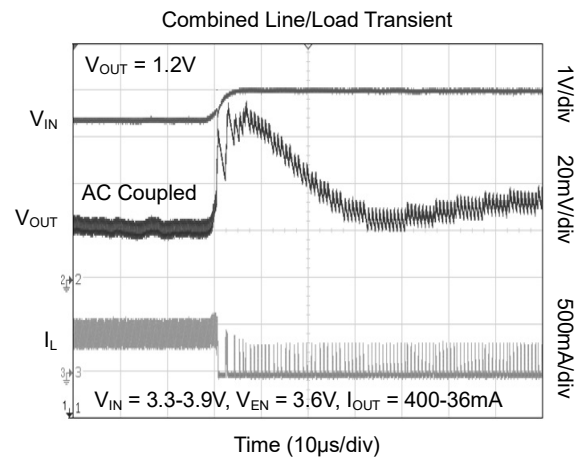
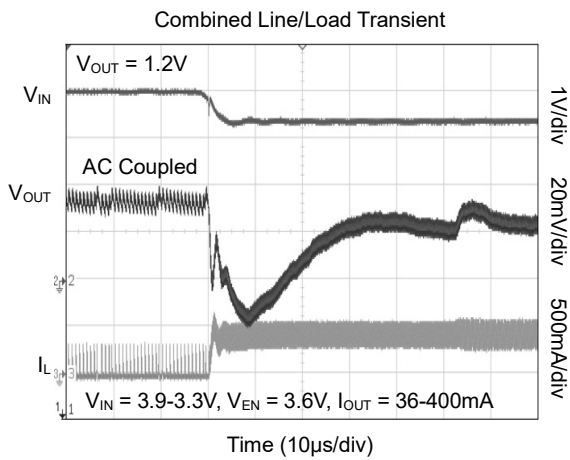
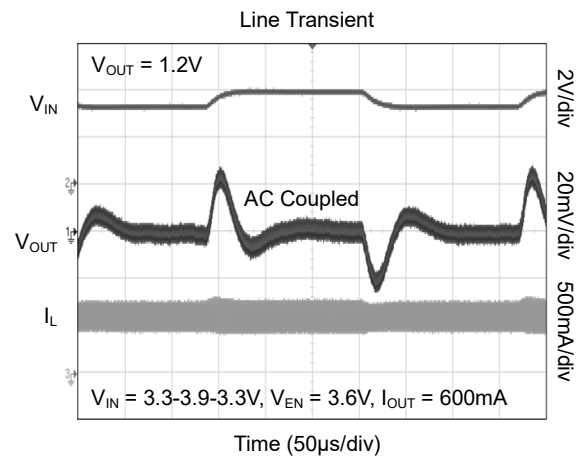
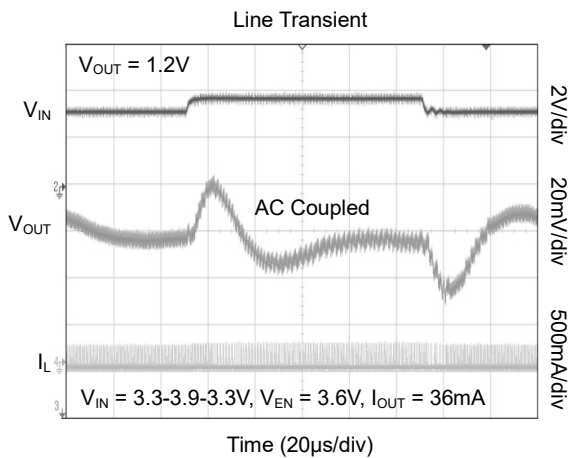
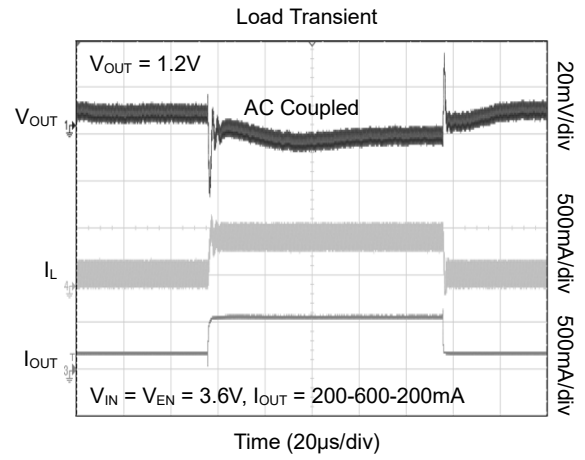
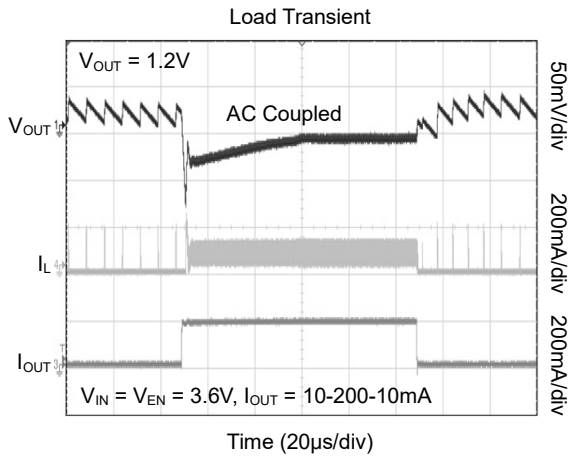

TYPICAL PERFORMANCE CHARACTERISTICS (continued)

T_A = +25°C, V_{IN} = V_{EN} = 3.6V, unless otherwise noted.

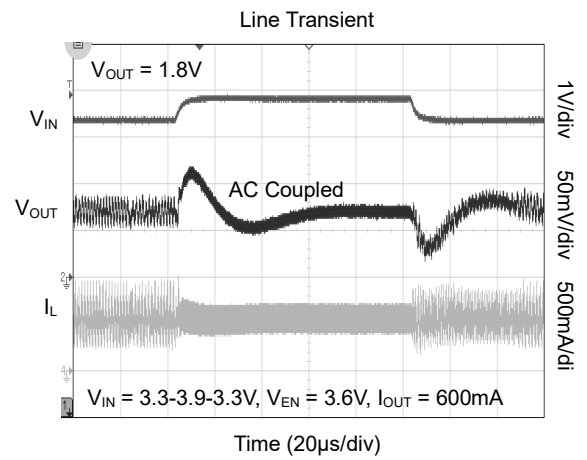
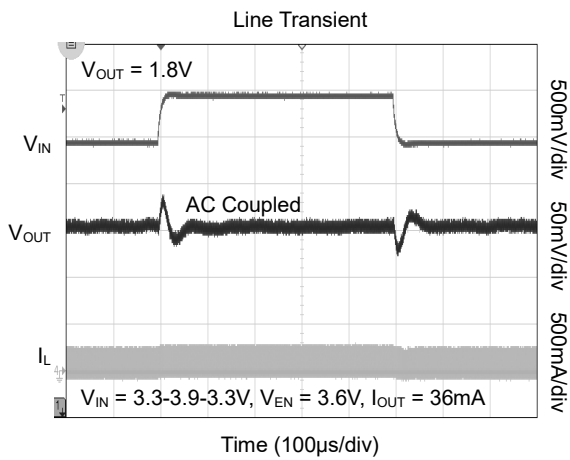
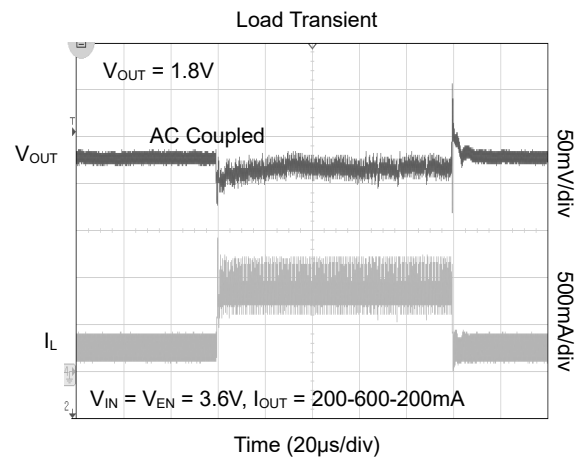
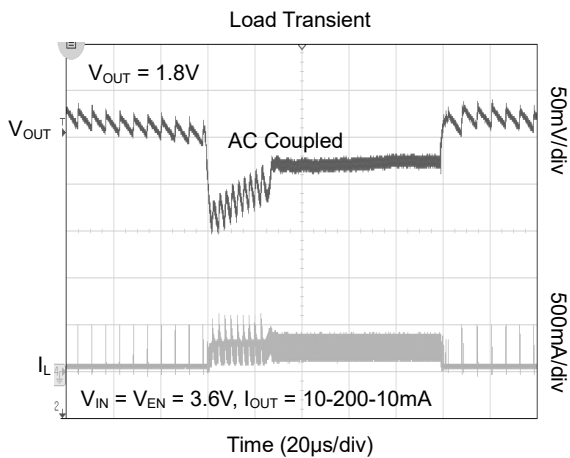
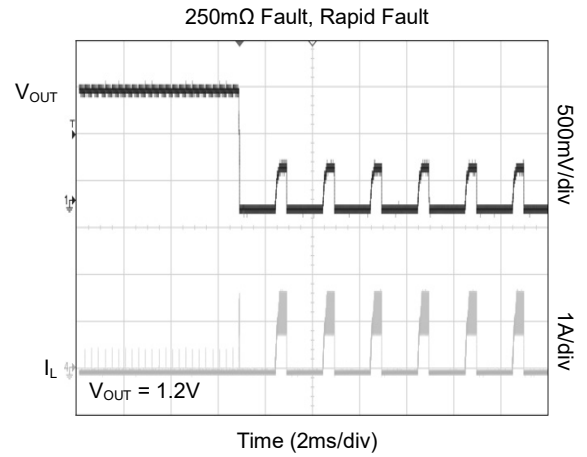
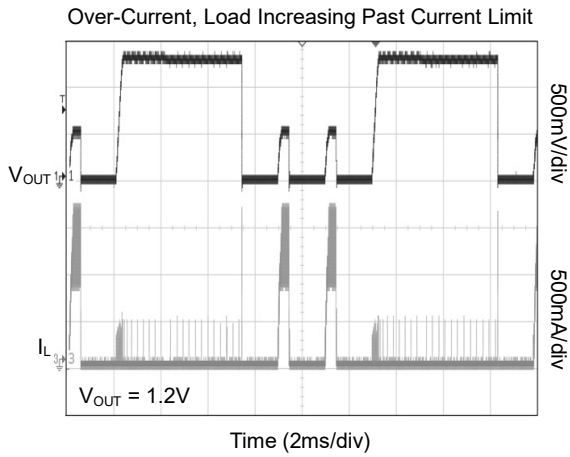

TYPICAL PERFORMANCE CHARACTERISTICS (continued)

T_A = +25°C, V_{IN} = V_{EN} = 3.6V, unless otherwise noted.

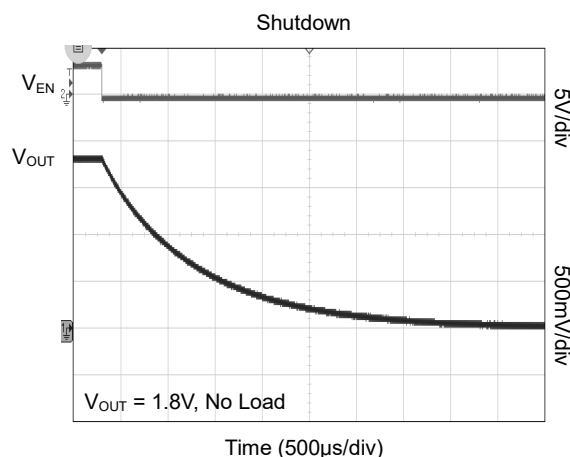
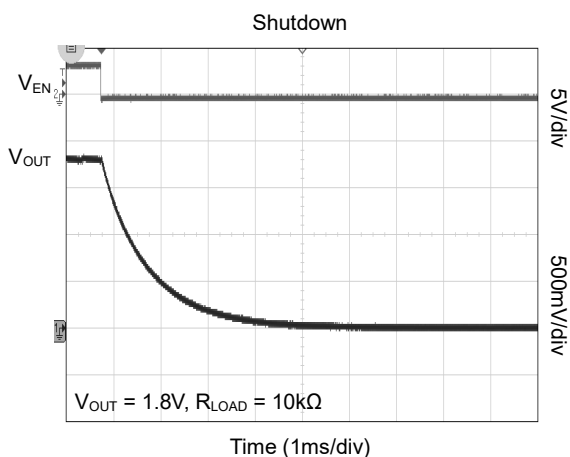
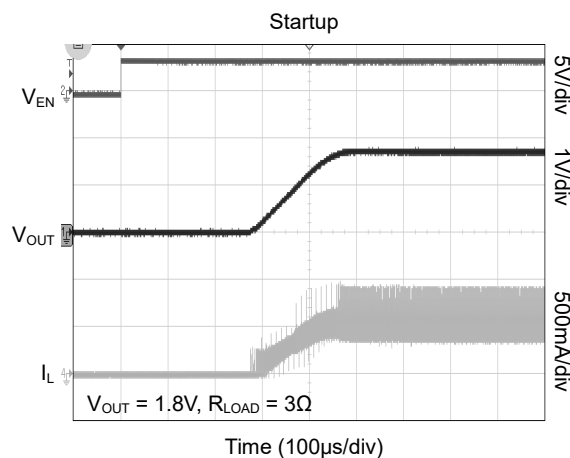
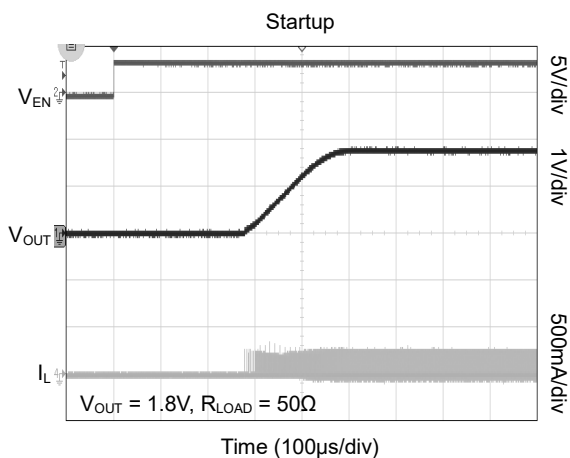

TYPICAL PERFORMANCE CHARACTERISTICS (continued)

T_A = +25°C, V_{IN} = V_{EN} = 3.6V, unless otherwise noted.

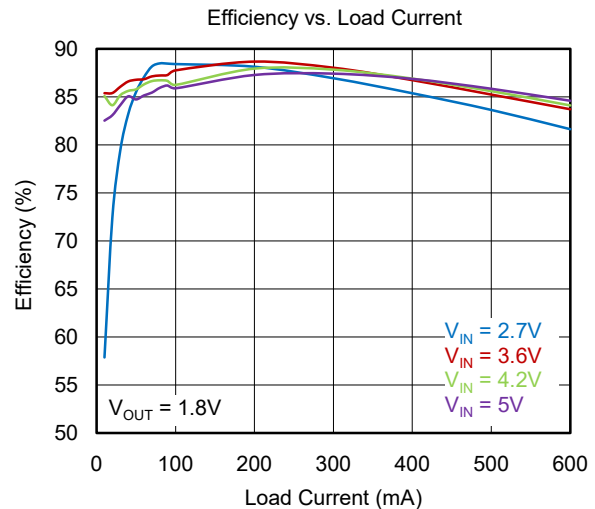
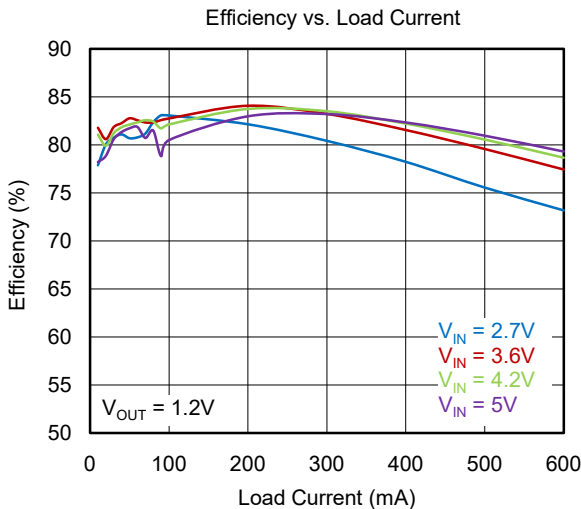
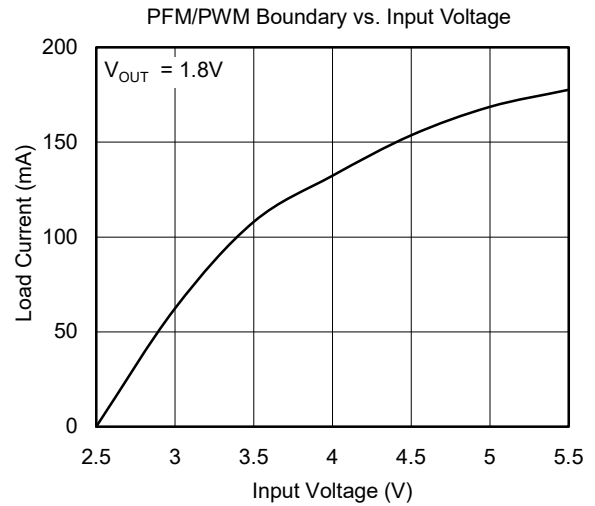
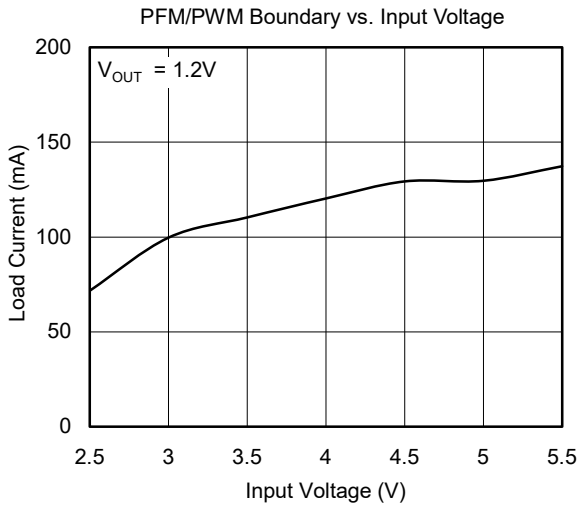
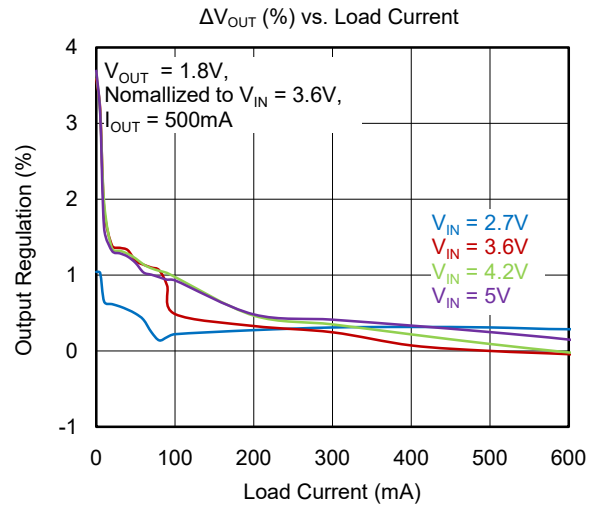
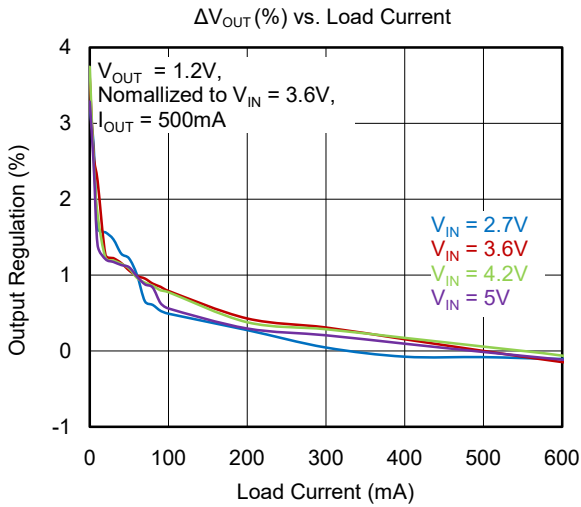

TYPICAL PERFORMANCE CHARACTERISTICS (continued)

T_A = +25°C, V_{IN} = V_{EN} = 3.6V, unless otherwise noted.

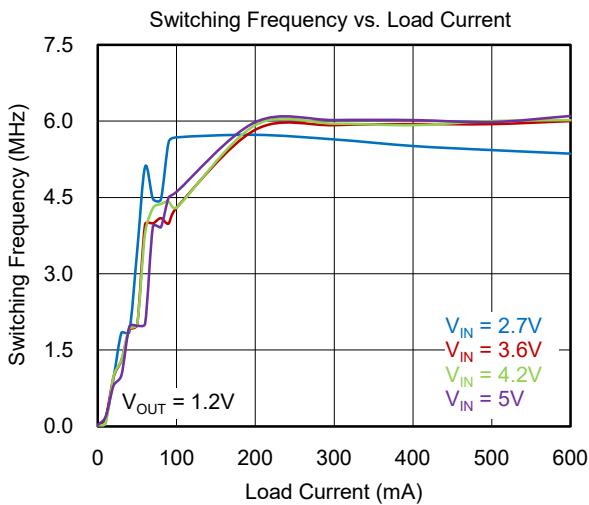
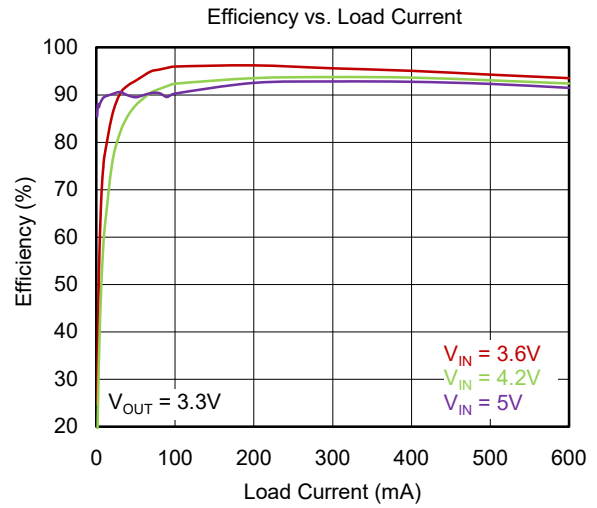
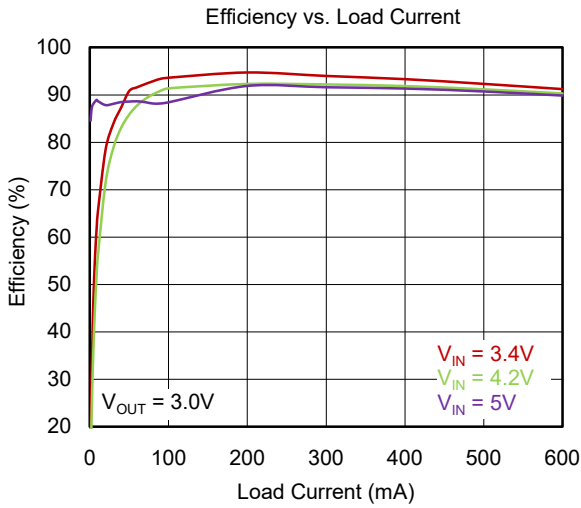
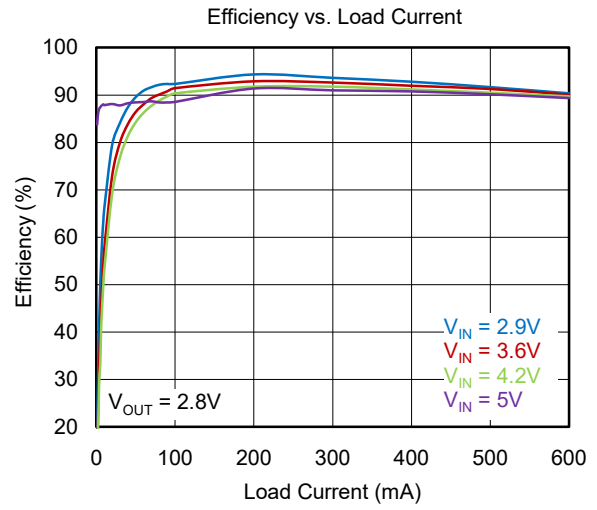
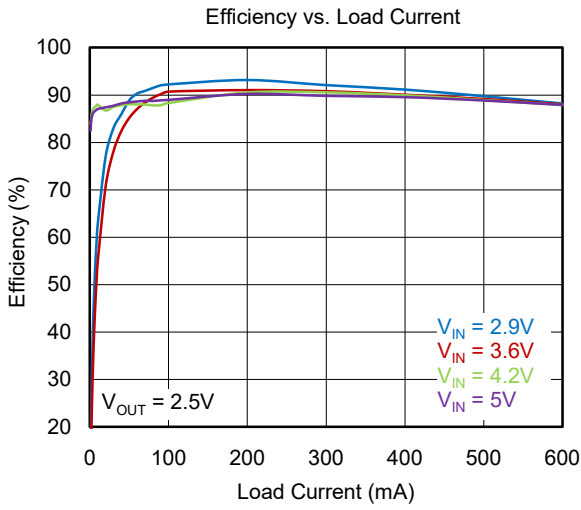

PCB Layout

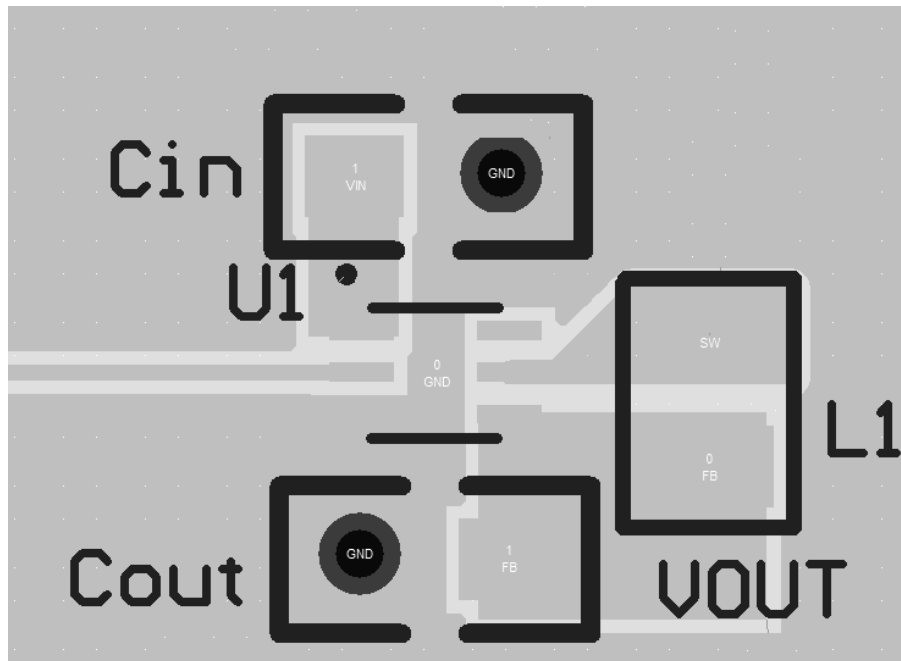

Figure 2. PCB Layout Guidance

REVISION HISTORY

NOTE: Page numbers for previous revisions may differ from page numbers in the current version.

JUNE 2018 – REV.A.2 to REV.A.3

Added Package Thermal Resistance	3
Updated Typical Performance Characteristics	10

FEBRUARY 2018 – REV.A.1 to REV.A.2

Updated Package/Ordering Information section	2
Added CDM	3
Updated Electrical Characteristics section	5
Updated Table 2	11

SEPTEMBER 2017 – REV.A to REV.A.1

Added WLCSP-1.21×0.81-6B package and SGM6032-1.6YTDI6G	All
--	-----

Changes from Original (APRIL 2017) to REV.A

Changed from product preview to production data	All
---	-----

PACKAGE OUTLINE DIMENSIONS

TDFN-2x2-6L

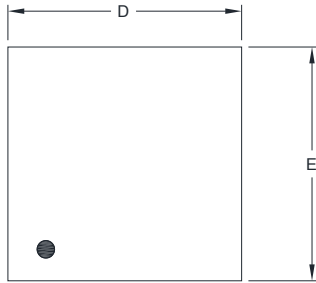

TOP VIEW

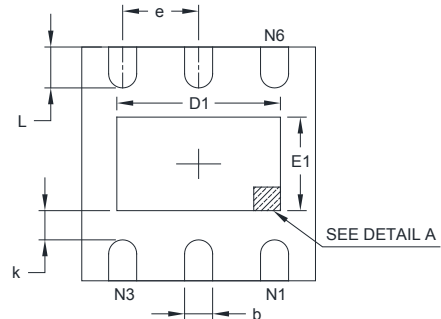

BOTTOM VIEW

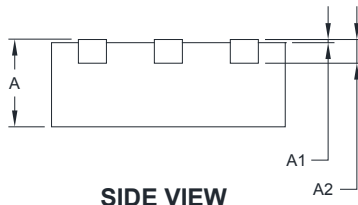

SIDE VIEW

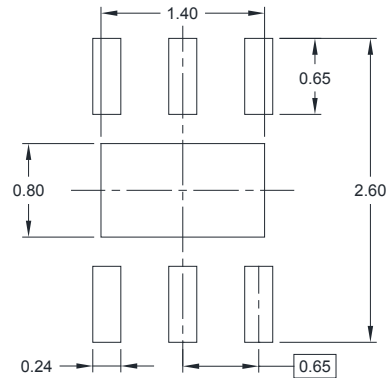

RECOMMENDED LAND PATTERN (Unit: mm)

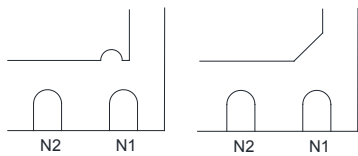

DETAIL A

Pin #1 ID and Tie Bar Mark Options

NOTE: The configuration of the Pin #1 identifier is optional, but must be located within the zone indicated.

Symbol	Dimensions In Millimeters		Dimensions In Inches	
	MIN	MAX	MIN	MAX
A	0.700	0.800	0.028	0.031
A1	0.000	0.050	0.000	0.002
A2	0.203 REF		0.008 REF	
D	1.900	2.100	0.075	0.083
D1	1.100	1.450	0.043	0.057
E	1.900	2.100	0.075	0.083
E1	0.600	0.850	0.024	0.034
k	0.200 MIN		0.008 MIN	
b	0.180	0.300	0.007	0.012
e	0.650 TYP		0.026 TYP	
L	0.250	0.450	0.010	0.018

PACKAGE OUTLINE DIMENSIONS

WLCSP-1.21×0.81-6B

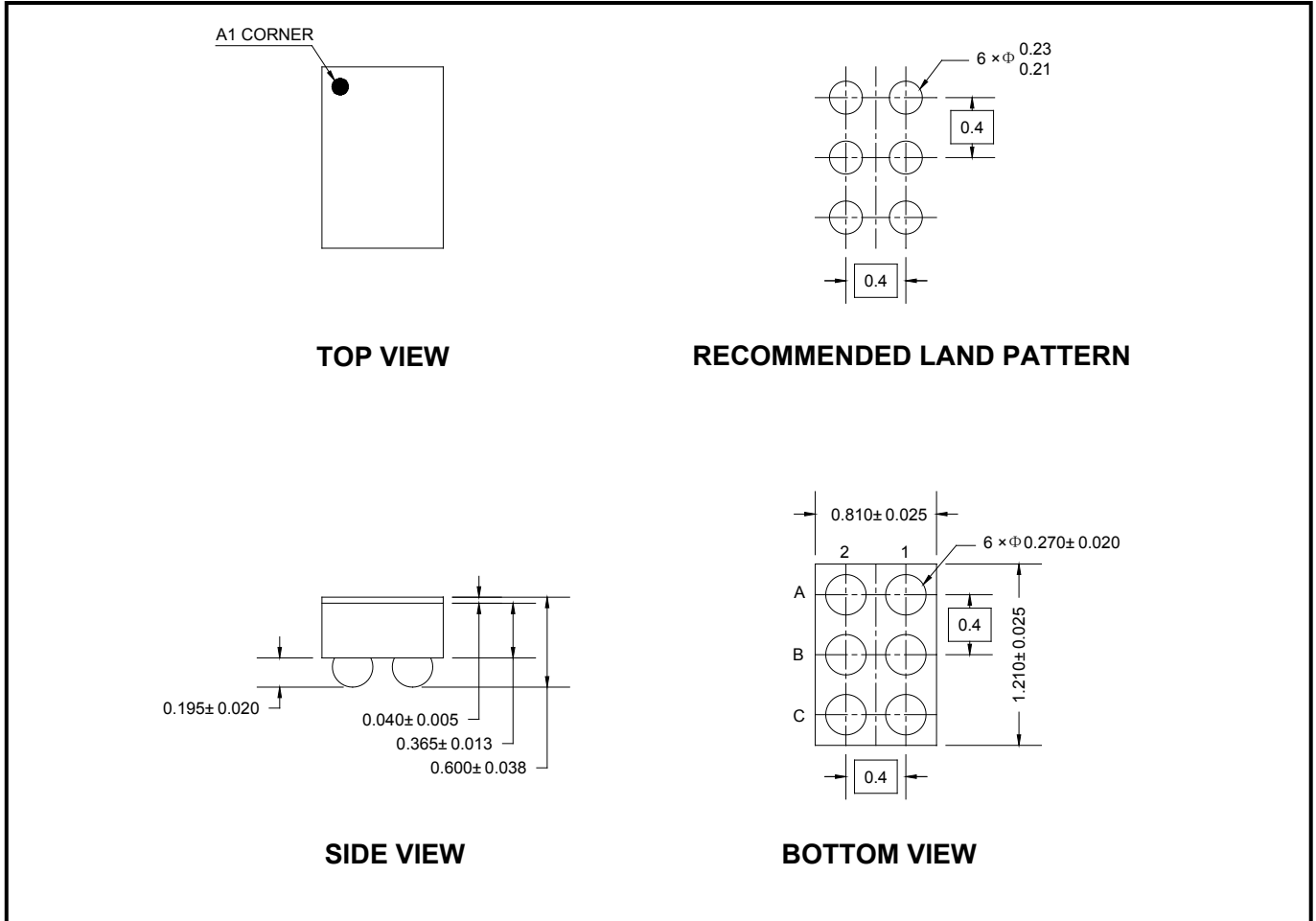

NOTE: All linear dimensions are in millimeters.

TAPE AND REEL INFORMATION

REEL DIMENSIONS



TAPE DIMENSIONS

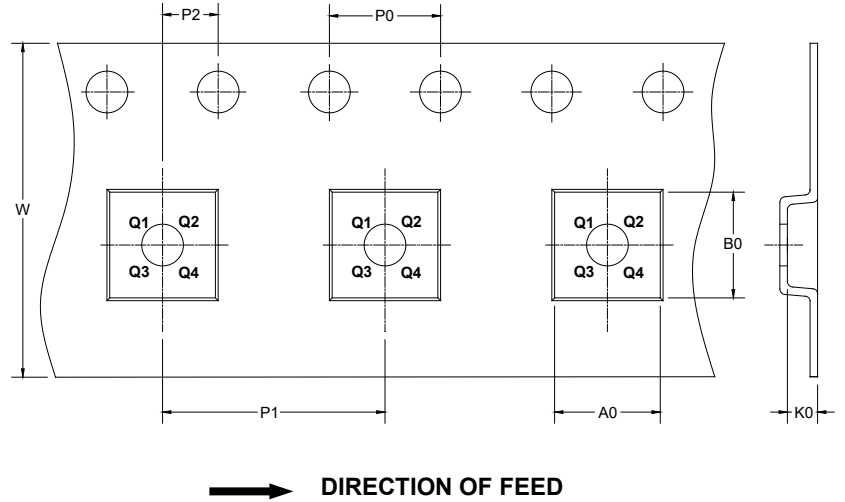

NOTE: The picture is only for reference. Please make the object as the standard.

KEY PARAMETER LIST OF TAPE AND REEL

Package Type	Reel Diameter	Reel Width W1 (mm)	A0 (mm)	B0 (mm)	K0 (mm)	P0 (mm)	P1 (mm)	P2 (mm)	W (mm)	Pin1 Quadrant
TDFN-2x2-6L	7"	9.5	2.30	2.30	1.10	4.0	4.0	2.0	8.0	Q1
WLCSP-1.21x0.81-6B	7"	9.2	0.90	1.32	0.68	4.0	4.0	2.0	8.0	Q1

000001

PACKAGE INFORMATION

CARTON BOX DIMENSIONS



NOTE: The picture is only for reference. Please make the object as the standard.

KEY PARAMETER LIST OF CARTON BOX

Reel Type	Length (mm)	Width (mm)	Height (mm)	Pizza/Carton
7" (Option)	368	227	224	8
7"	442	410	224	18

DD0002