

GENERAL DESCRIPTION

The SGM9115 is a rail-to-rail, triple 3rd-order output reconstruction filter which can operate from 3.3V to 5.5V single power supply. Compared with typical passive solutions, triple 3rd-order filters provide better image quality.

The device has a -3dB bandwidth of 9MHz and 44V/ μ s slew rate. The drivers in SGM9115 can drive DC- or AC-coupled single (150 Ω) or dual (75 Ω) loads.

The device allows DC-coupled output. An internal level shift circuit avoids synchronous pulse limit. SGM9115 can be DC-coupled or AC-coupled with input video signal to eliminate out-of-band noise, such as the output stage of DAC. Internal clamp and bias circuitry may be used if AC-coupled inputs are required.

The SGM9115 is available in a Green SOIC-8 package. It operates over an ambient temperature range of -40°C to +125°C.

FEATURES

- **Supply Voltage Range: 3.3V to 5.5V**
- **Triple 3rd-Order 9MHz (SD) Filters**
- **Transparent Input Clamping**
- **Internal Gain: 6dB**
- **Drive Dual Video Loads**
- **AC- or DC-Coupled Inputs**
- **AC- or DC-Coupled Outputs**
- **Rail-to-Rail Output**
- **-40°C to +125°C Operating Temperature Range**
- **Available in a Green SOIC-8 Package**

APPLICATIONS

- Video Amplifiers
- Video Recorders
- Video on Demand (VOD)
- Cable and Satellite Set-Top Boxes
- Portable and Handheld Products
- Communication Devices
- SDTVs

BLOCK DIAGRAM

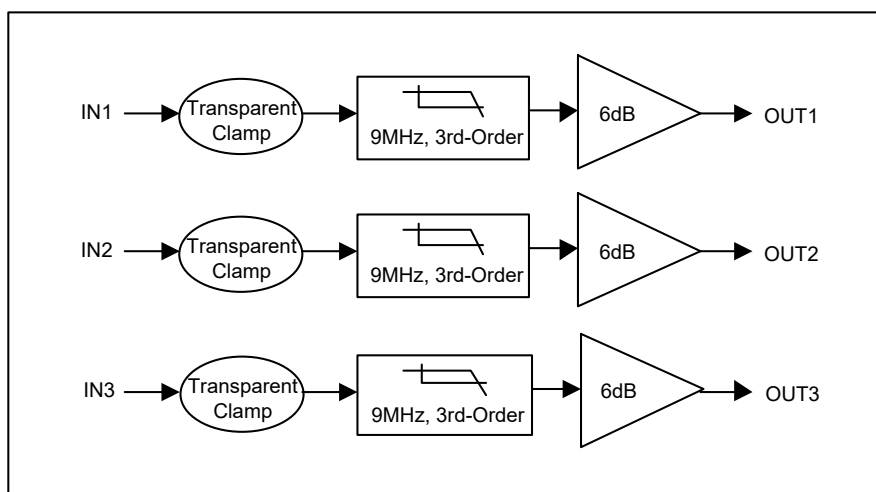

PACKAGE/ORDERING INFORMATION

MODEL	PACKAGE DESCRIPTION	SPECIFIED TEMPERATURE RANGE	ORDERING NUMBER	PACKAGE MARKING	PACKING OPTION
SGM9115	SOIC-8	-40°C to +125°C	SGM9115XS/TR	SGM9115XS XXXXX	Tape and Reel, 2500

MARKING INFORMATION

NOTE: XXXXXX = Date Code and Vendor Code.

XXXXX

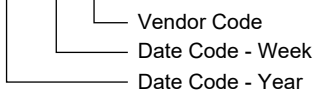

Green (RoHS & HSF): SG Micro Corp defines "Green" to mean Pb-Free (RoHS compatible) and free of halogen substances. If you have additional comments or questions, please contact your SGMICRO representative directly.

- Input Voltage Range GND - 0.3V to (+V_S) + 0.3V
- Supply Voltage, GND to +V_S..... 7.5V
- Power Dissipation, P_D @ T_A = +25°C
- SOIC-8..... 0.8W
- Package Thermal Resistance
- SOIC-8, θ_{JA}.....128°C/W
- Junction Temperature 150°C
- Storage Temperature Range..... -65°C to +150°C
- Lead Temperature (Soldering, 10s) 260°C
- ESD Susceptibility
- HBM..... 8000V
- MM..... 400V

RECOMMENDED OPERATING CONDITIONS

- Operating Voltage Range..... 3.3V to 5.5V
- Operating Temperature Range -40°C to +125°C

OVERSTRESS CAUTION

Stresses beyond those listed in Absolute Maximum Ratings may cause permanent damage to the device. Exposure to absolute maximum rating conditions for extended periods may affect reliability. Functional operation of the device at any conditions beyond those indicated in the Recommended Operating Conditions section is not implied.

ESD SENSITIVITY CAUTION

This integrated circuit can be damaged if ESD protections are not considered carefully. SGMICRO recommends that all integrated circuits be handled with appropriate precautions. Failure to observe proper handling and installation procedures can cause damage. ESD damage can range from subtle performance degradation to complete device failure. Precision integrated circuits may be more susceptible to damage because even small parametric changes could cause the device not to meet the published specifications.

DISCLAIMER

SG Micro Corp reserves the right to make any change in circuit design, or specifications without prior notice.

PIN CONFIGURATION

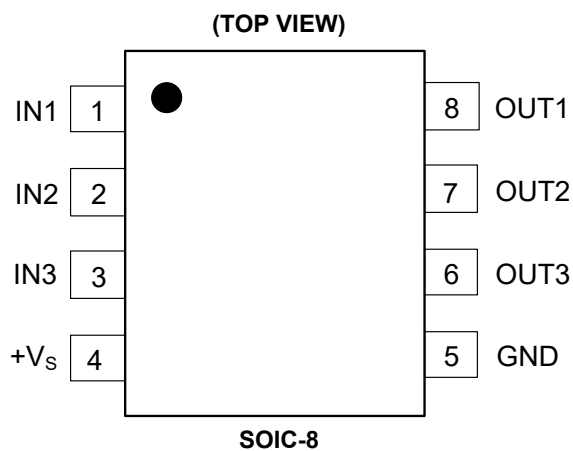

PIN DESCRIPTION

PIN	NAME	FUNCTION
1	IN1	Video Input for Channel 1.
2	IN2	Video Input for Channel 2.
3	IN3	Video Input for Channel 3.
4	+V _s	Power Supply.
5	GND	Ground.
6	OUT3	Filtered Output for Channel 3.
7	OUT2	Filtered Output for Channel 2.
8	OUT1	Filtered Output for Channel 1.

ELECTRICAL CHARACTERISTICS(At $R_L = 150\Omega$ connected to GND, $V_{IN} = 1V_{PP}$ and $C_{IN} = 0.1\mu F$, all outputs AC-coupled with $220\mu F$, unless otherwise noted.)

PARAMETER	CONDITIONS	SGM9115						
		TYP	MIN/MAX OVER TEMPERATURE				UNITS	MIN/ MAX
		+25°C	+25°C	-40°C to +85°C	-40°C to +125°C			
Input Characteristics								
Output Level Shift Voltage (V_{OLS})	$V_{IN} = 0V$, no load	380	570	670	700	mV	MAX	
Input Voltage Clamp (V_{CLAMP})	$I_{IN} = -1mA$	-105	-220	-300	-350	mV	MIN	
Clamp Charge Current	$V_{IN} = V_{CLAMP} - 100mV$	-5	-5.9	-8.0	-9.0	mA	MIN	
Voltage Gain (A_V)	$R_L = 150\Omega$	2.0	1.95	1.91	1.90	V/V	MIN	
			2.04	2.08	2.09	V/V	MAX	
Output Characteristics								
Output Voltage High Swing	$V_{IN} = 3V$, $R_L = 150\Omega$ to GND	4.4	4.3	4.25	4.2	V	MIN	
Power Supply								
Operating Voltage Range			3.3			V	MIN	
			5.5			V	MAX	
Power Supply Rejection Ratio (PSRR)	$V_S = 3.3V$ to $5.5V$	60	58	57	56	dB	MIN	
Quiescent Current (I_Q)	$V_{IN} = 500mV$	21	26	30	33	mA	MAX	
Dynamic Performance								
$\pm 0.1dB$ Bandwidth	$R_L = 150\Omega$	5.5				MHz	TYP	
-3dB Bandwidth	$R_L = 150\Omega$	9.0				MHz	TYP	
Filter Response Normalized Gain: $f_{IN} = 27MHz$		-46				dB	TYP	
Slew Rate	20% to 80%, $V_{IN} = 1V$ Step	44				V/ μs	TYP	
Differential Gain (DG)	NTSC & PAL DC-coupled	0.57				%	TYP	
	NTSC & PAL AC-coupled	0.86				%	TYP	
Differential Phase (DP)	NTSC & PAL DC-coupled	0.85				°	TYP	
	NTSC & PAL AC-coupled	1.41				°	TYP	
Group Delay Variation (D/DT)	Difference between 400kHz and 6.5MHz	31				ns	TYP	
Crosstalk (channel-to-channel)	at 1MHz	-64				dB	TYP	
Fall Time	$2.0V_{STEP}$, 80% to 20%	36				ns	TYP	
Rise Time	$2.0V_{STEP}$, 80% to 20%	38				ns	TYP	

TYPICAL PERFORMANCE CHARACTERISTICS

At $V_S = +5.0V$, $T_A = +25^\circ C$, $R_L = 150\Omega$, all outputs AC-coupled with $220\mu F$, unless otherwise noted.

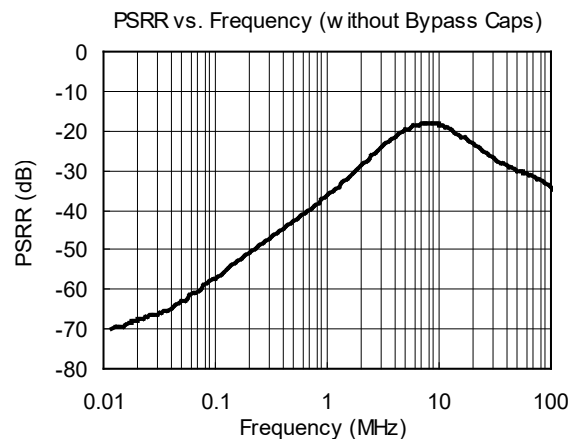
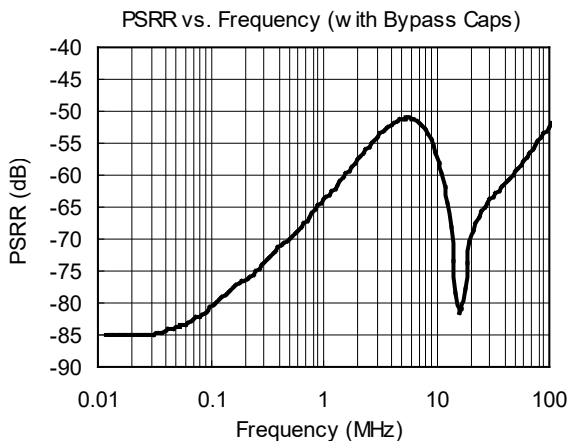
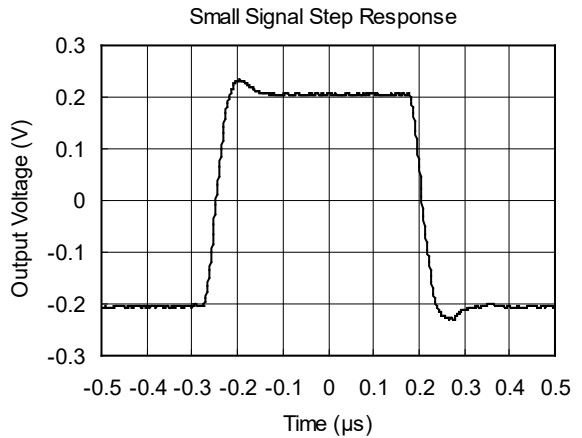
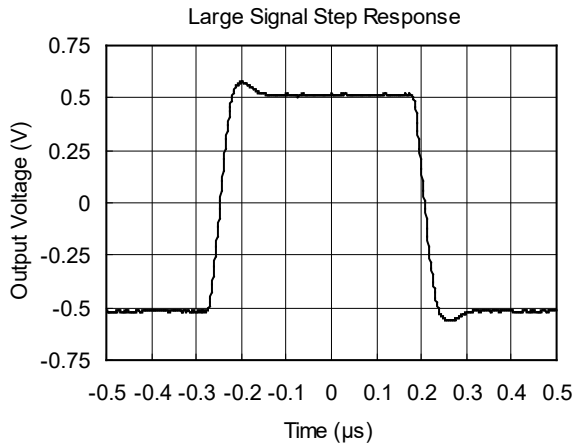
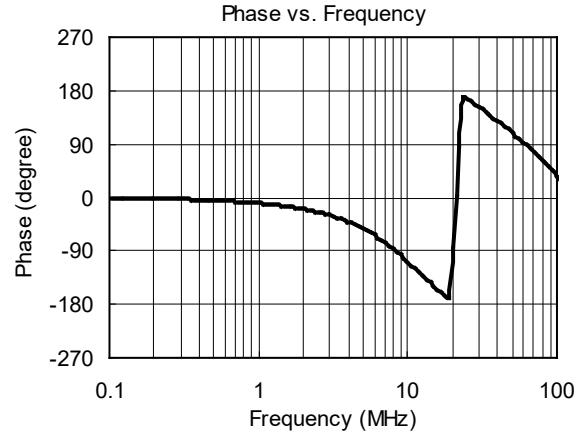
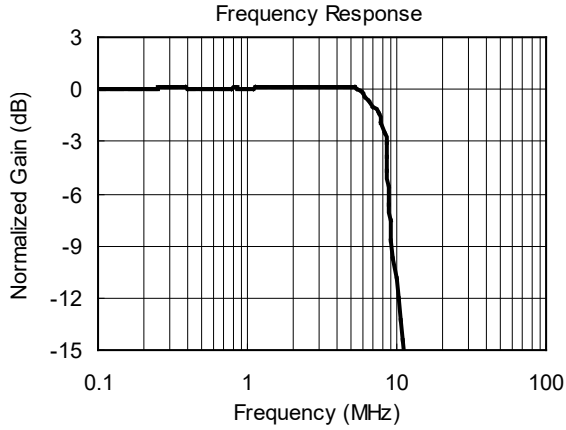

TYPICAL PERFORMANCE CHARACTERISTICS (continued)

At $V_S = +5.0V$, $T_A = +25^\circ C$, $R_L = 150\Omega$, all outputs AC-coupled with $220\mu F$, unless otherwise noted.

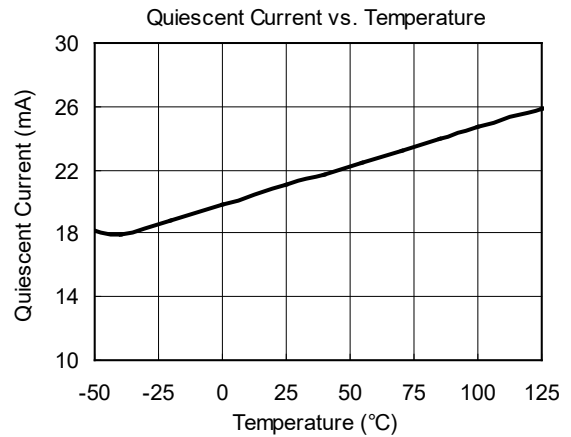
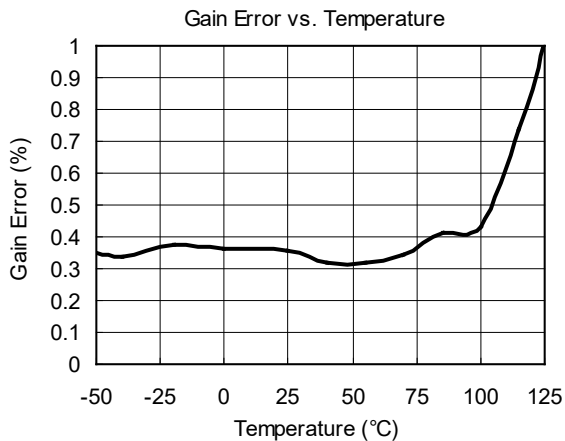
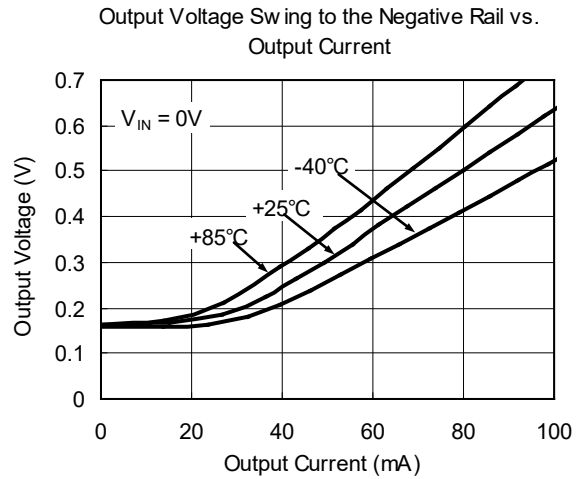
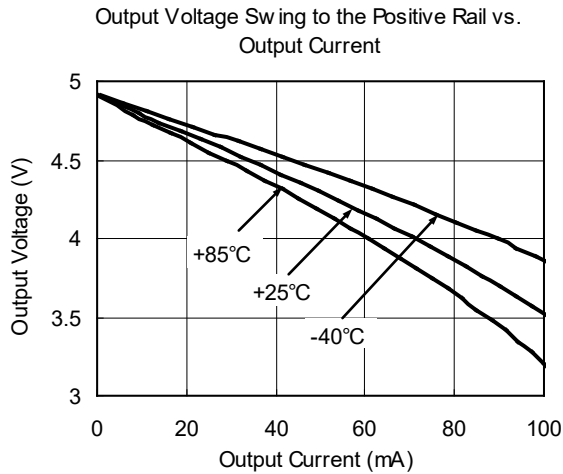
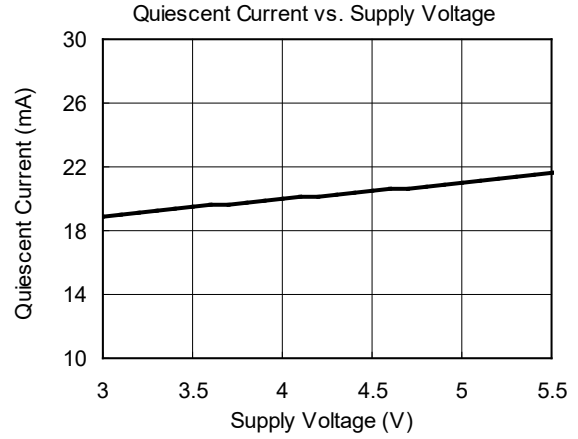
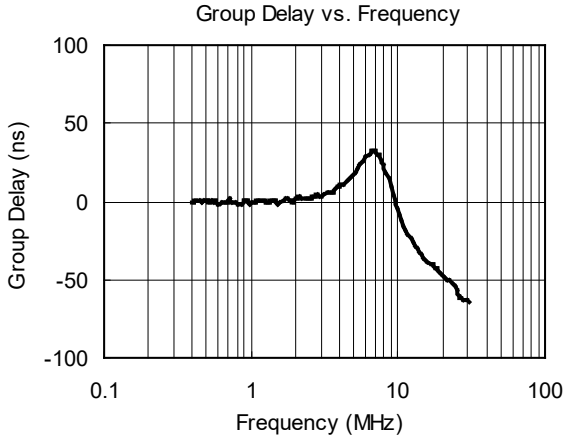

PACKAGE OUTLINE DIMENSIONS

SOIC-8

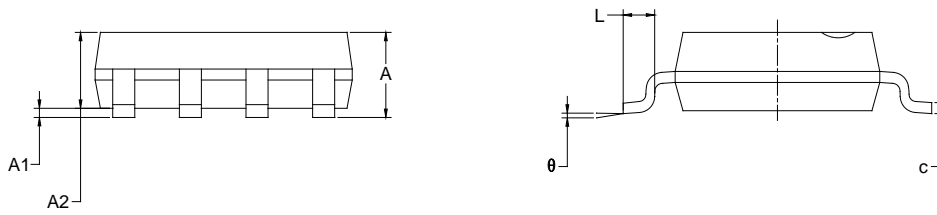
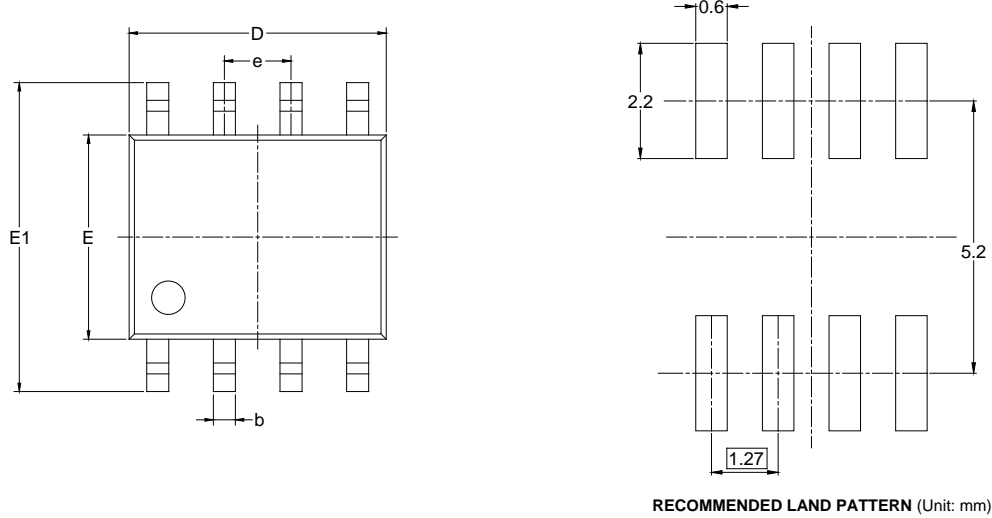

Symbol	Dimensions In Millimeters		Dimensions In Inches	
	MIN	MAX	MIN	MAX
A	1.350	1.750	0.053	0.069
A1	0.100	0.250	0.004	0.010
A2	1.350	1.550	0.053	0.061
b	0.330	0.510	0.013	0.020
c	0.170	0.250	0.006	0.010
D	4.700	5.100	0.185	0.200
E	3.800	4.000	0.150	0.157
E1	5.800	6.200	0.228	0.244
e	1.27 BSC		0.050 BSC	
L	0.400	1.270	0.016	0.050
θ	0°	8°	0°	8°

NOTES:
 1. Body dimensions do not include mode flash or protrusion.
 2. This drawing is subject to change without notice.

PACKAGE INFORMATION

TAPE AND REEL INFORMATION

REEL DIMENSIONS

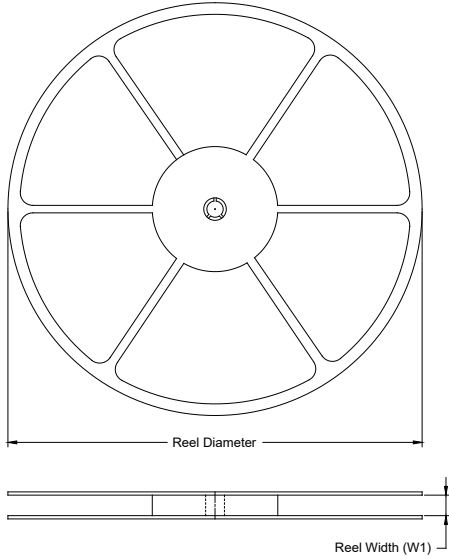

TAPE DIMENSIONS

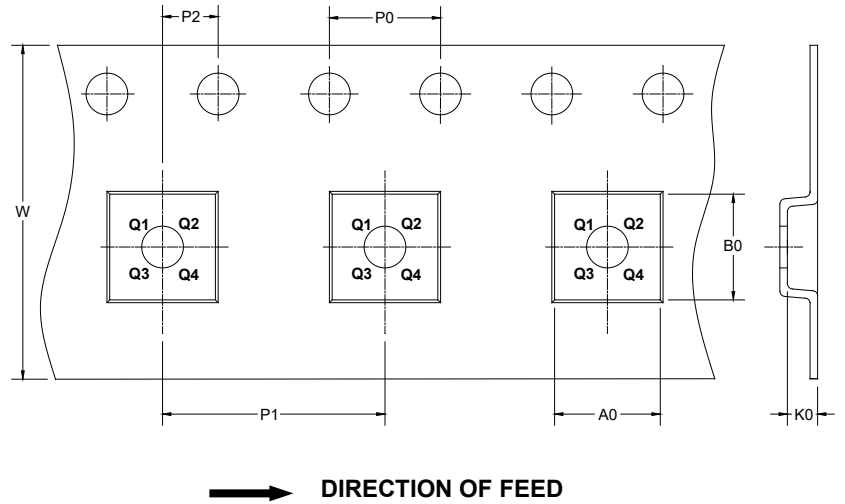

NOTE: The picture is only for reference. Please make the object as the standard.

KEY PARAMETER LIST OF TAPE AND REEL

Package Type	Reel Diameter	Reel Width W1 (mm)	A0 (mm)	B0 (mm)	K0 (mm)	P0 (mm)	P1 (mm)	P2 (mm)	W (mm)	Pin1 Quadrant
SOIC-8	13"	12.4	6.40	5.40	2.10	4.0	8.0	2.0	12.0	Q1

DD0001

PACKAGE INFORMATION

CARTON BOX DIMENSIONS



NOTE: The picture is only for reference. Please make the object as the standard.

KEY PARAMETER LIST OF CARTON BOX

Reel Type	Length (mm)	Width (mm)	Height (mm)	Pizza/Carton
13"	386	280	370	5

DD0002