



SGM8926

110kHz, Rail-to-Rail Output CMOS Operational Amplifier

GENERAL DESCRIPTION

The SGM8926 (dual) is a low offset voltage, low power, voltage feedback amplifier. The device can operate from 1.6V to 5.5V single supply, while consuming only 6.4 μ A quiescent current per amplifier. It provides a wide input common mode voltage range and rail-to-rail output voltage swing. This feature makes SGM8926 appropriate for buffering ASIC.

The SGM8926 offers a gain-bandwidth product of 110kHz and an ultra-low input bias current of 1pA. It is well suited for piezoelectric sensors, integrators and photodiode amplifiers.

The SGM8926 is designed into a wide range of applications, such as battery-powered instrumentation, safety monitoring, portable systems, and transducer interface circuits in low power systems.

The SGM8926 is available in Green MSOP-8 and SOIC-8 packages. It is specified over the extended -40°C to +85°C temperature range.

FEATURES

- **Low Offset Voltage: 0.9mV (MAX)**
- **Unity-Gain Stable**
- **Gain-Bandwidth Product: 110kHz**
- **Rail-to-Rail Output**
- **Supply Voltage Range: 1.6V to 5.5V**
- **Low Supply Current: 6.4 μ A/Amplifier (TYP)**
- **-40°C to +85°C Operating Temperature Range**
- **Available in Green SOIC-8 and MSOP-8 Packages**

APPLICATIONS

ASIC Input or Output Amplifiers
Piezoelectric Transducer Amplifiers
Battery-Powered Equipment
Portable Systems
Sensor Interfaces
Medical Instrumentation
Mobile Communications
Audio Outputs
Smoke Detectors
Mobile Telephones
Notebook PCs
PCMCIA Cards

PACKAGE/ORDERING INFORMATION

MODEL	PACKAGE DESCRIPTION	SPECIFIED TEMPERATURE RANGE	ORDERING NUMBER	PACKAGE MARKING	PACKING OPTION
SGM8926	SOIC-8	-40°C to +85°C	SGM8926YS8G/TR	SGM 8926YS8 XXXXX	Tape and Reel, 2500
	MSOP-8	-40°C to +85°C	SGM8926YMS8G/TR	SGM8926 YMS8 XXXXX	Tape and Reel, 3000

MARKING INFORMATION

NOTE: XXXXX = Date Code and Vendor Code.

SOIC-8/MSOP-8

XXXXX

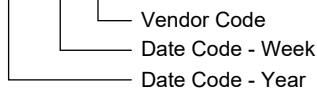

Green (RoHS & HSF): SG Micro Corp defines "Green" to mean Pb-Free (RoHS compatible) and free of halogen substances. If you have additional comments or questions, please contact your SGMICRO representative directly.

ABSOLUTE MAXIMUM RATINGS

- Supply Voltage, +Vs to -Vs6V
- Input Common Mode Voltage Range
..... (-Vs) - 0.1V to (+Vs) - 1.3V
- Junction Temperature.....+150°C
- Storage Temperature Range-65°C to +150°C
- Lead Temperature (Soldering, 10s).....+260°C
- ESD Susceptibility
- HBM..... 8000V
- MM..... 400V

RECOMMENDED OPERATING CONDITIONS

- Operating Temperature Range-40°C to +85°C

OVERSTRESS CAUTION

Stresses beyond those listed in Absolute Maximum Ratings may cause permanent damage to the device. Exposure to absolute maximum rating conditions for extended periods may affect reliability. Functional operation of the device at any conditions beyond those indicated in the Recommended Operating Conditions section is not implied.

ESD SENSITIVITY CAUTION

This integrated circuit can be damaged if ESD protections are not considered carefully. SGMICRO recommends that all integrated circuits be handled with appropriate precautions. Failure to observe proper handling and installation procedures

can cause damage. ESD damage can range from subtle performance degradation to complete device failure. Precision integrated circuits may be more susceptible to damage because even small parametric changes could cause the device not to meet the published specifications.

DISCLAIMER

SG Micro Corp reserves the right to make any change in circuit design, or specifications without prior notice.

PIN CONFIGURATIONS

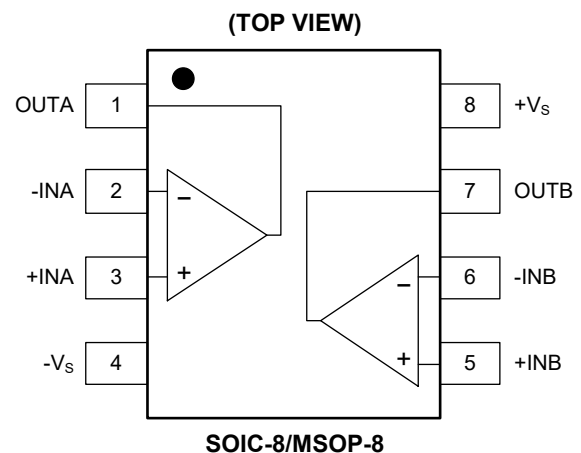

ELECTRICAL CHARACTERISTICS(At $T_A = +25^\circ\text{C}$, $V_S = 5\text{V}$, $V_{OUT} = V_S/2$, Full = -40°C to $+85^\circ\text{C}$, unless otherwise noted.)

PARAMETER	CONDITIONS	TEMP	MIN	TYP	MAX	UNITS
DC Performance						
Input Offset Voltage (V_{OS})	$V_{CM} = V_S/2$	$+25^\circ\text{C}$		0.15	0.9	mV
Input Offset Voltage Drift ($\Delta V_{OS}/\Delta T$)		Full		2.5		$\mu\text{V}/^\circ\text{C}$
Open-Loop Voltage Gain (A_{OL})	$R_L = 100\text{k}\Omega$ to $V_S/2$, $V_{OUT} = 0.05\text{V}$ to 4.95V	$+25^\circ\text{C}$		93		dB
		$+25^\circ\text{C}$	80	88		
	Full	77				
Input Characteristics						
Common Mode Rejection Ratio (CMRR)	$V_{CM} = -0.1\text{V}$ to 3.7V	$+25^\circ\text{C}$	69	85		dB
		Full	67			
Output Characteristics						
Output Voltage Swing from Rail	$R_L = 10\text{k}\Omega$ to $V_S/2$	$+25^\circ\text{C}$		21	39	mV
		Full			42	
	$R_L = 2\text{k}\Omega$ to $V_S/2$	$+25^\circ\text{C}$		80	105	
		Full			115	
Output Short-Circuit Current (I_{SC})	$R_L = 10\Omega$ to $V_S/2$	$+25^\circ\text{C}$	24	36		mA
		Full	18			
Power Supply						
Quiescent Current/Amplifier (I_Q)	$I_{OUT} = 0\text{mA}$	$+25^\circ\text{C}$		6.4	11.5	μA
		Full			14	
Power Supply Rejection Ratio (PSRR)	$V_S = 1.6\text{V}$ to 5.5V , $V_{CM} = 0.3\text{V}$	$+25^\circ\text{C}$	64	77		dB
		Full	62			
Dynamic Performance						
Gain-Bandwidth Product (GBP)	$R_L = 100\text{k}\Omega$, $C_L = 100\text{pF}$, $V_{CM} = 2.5\text{V}$	$+25^\circ\text{C}$		110		kHz
Slew Rate (SR)	$V_{CM} = 2.5\text{V}$	$+25^\circ\text{C}$		0.04		$\text{V}/\mu\text{s}$
Crosstalk	$f = 1\text{kHz}$	$+25^\circ\text{C}$		90		dB
Noise Performance						
Input Voltage Noise Density (e_n)	$f = 1\text{kHz}$	$+25^\circ\text{C}$		105		$\text{nV}/\sqrt{\text{Hz}}$

ELECTRICAL CHARACTERISTICS (continued)(At $T_A = +25^\circ\text{C}$, $V_S = 1.6\text{V}$, $V_{CM} = 0.3\text{V}$, $V_{OUT} = V_S/2$, Full = -40°C to $+85^\circ\text{C}$, unless otherwise noted.)

PARAMETER	CONDITIONS	TEMP	MIN	TYP	MAX	UNITS
DC Performance						
Input Offset Voltage (V_{OS})		+25°C		0.25	0.9	mV
Input Offset Voltage Drift ($\Delta V_{OS}/\Delta T$)		Full		1.8		$\mu\text{V}/^\circ\text{C}$
Open-Loop Voltage Gain (A_{OL})	$R_L = 100\text{k}\Omega$ to $V_S/2$, $V_{OUT} = 0.05\text{V}$ to 1.55V	+25°C		99		dB
		+25°C	79	91		
	Full	78				
Input Characteristics						
Common Mode Rejection Ratio (CMRR)	$V_{CM} = -0.1\text{V}$ to 0.3V	+25°C	64	78		dB
		Full	62			
Output Characteristics						
Output Voltage Swing from Rail	$R_L = 10\text{k}\Omega$ to $V_S/2$	+25°C		13	25	mV
		Full			28	
	$R_L = 2\text{k}\Omega$ to $V_S/2$	+25°C		63	87	
		Full			90	
Output Short-Circuit Current (I_{SC})	$R_L = 10\Omega$ to $V_S/2$	+25°C	0.4	2.6		mA
		Full	0.25			
Power Supply						
Quiescent Current/Amplifier (I_Q)	$I_{OUT} = 0\text{mA}$	+25°C		5.8	10	μA
		Full			13.5	
Dynamic Performance						
Gain-Bandwidth Product (GBP)	$R_L = 100\text{k}\Omega$, $C_L = 100\text{pF}$	+25°C		110		kHz
Slew Rate (SR)		+25°C		0.04		$\text{V}/\mu\text{s}$
Crosstalk	$f = 1\text{kHz}$	+25°C		90		dB
Noise Performance						
Input Voltage Noise Density (e_n)	$f = 1\text{kHz}$	+25°C		105		$\text{nV}/\sqrt{\text{Hz}}$

TYPICAL PERFORMANCE CHARACTERISTICS

At $T_A = +25^\circ\text{C}$, $V_S = 5\text{V}$, unless otherwise noted.

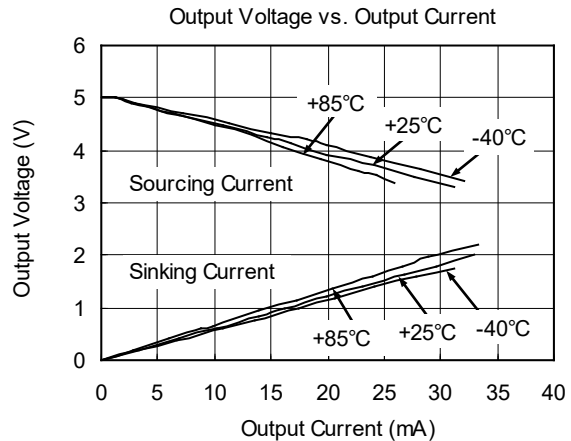
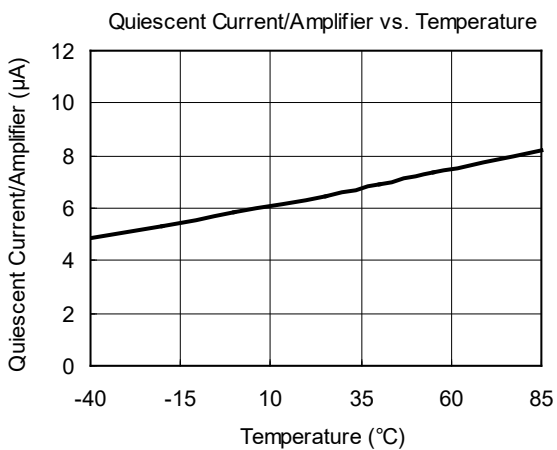
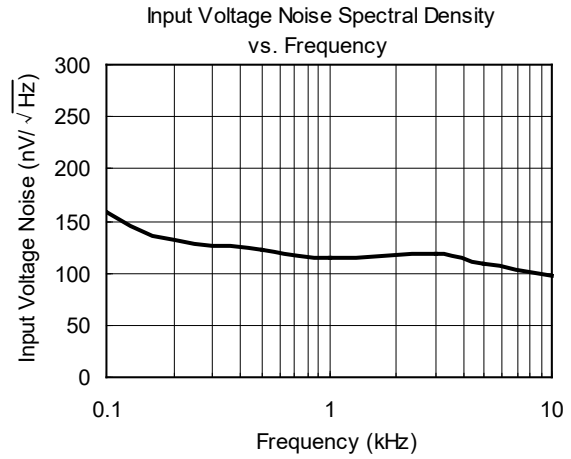
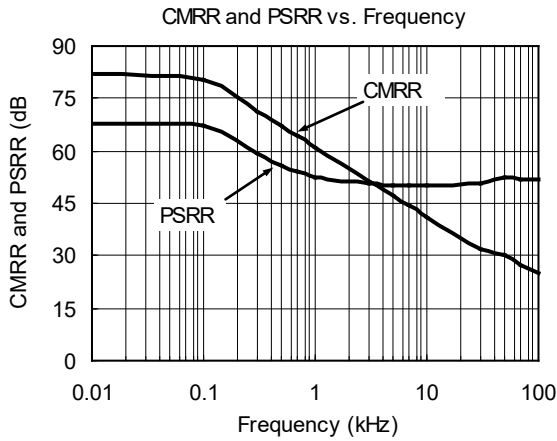
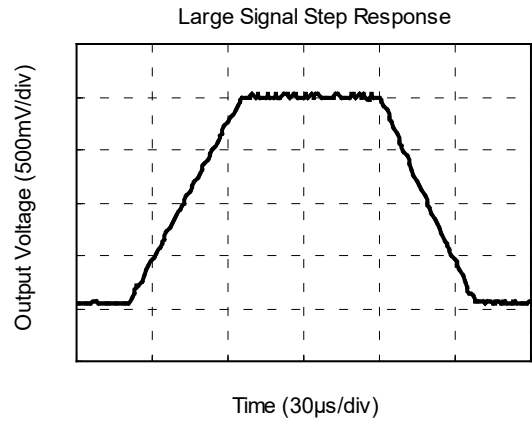
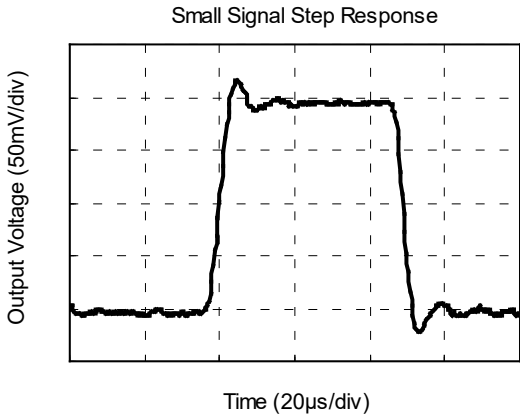

TYPICAL PERFORMANCE CHARACTERISTICS (continued)

At $T_A = +25^\circ\text{C}$, $V_S = 5\text{V}$, unless otherwise noted.

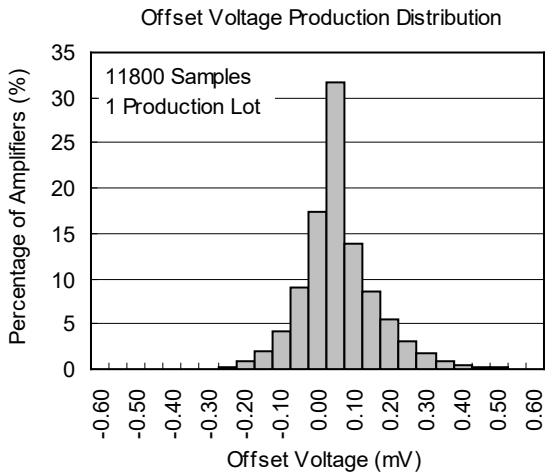
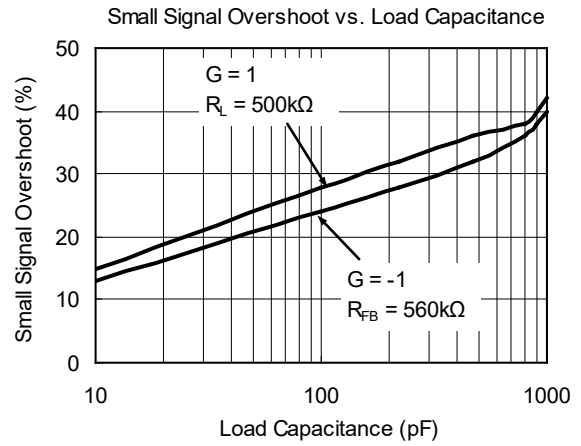
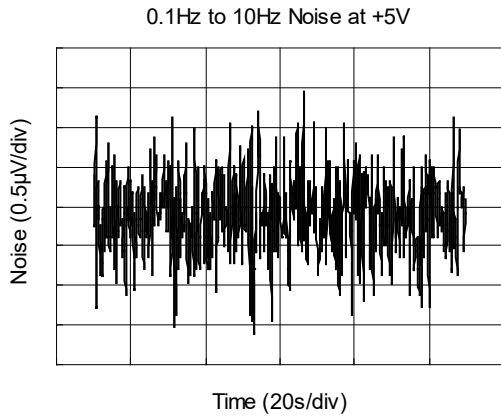

REVISION HISTORY

NOTE: Page numbers for previous revisions may differ from page numbers in the current version.

Changes from Original (DECEMBER 2013) to REV.A	Page
Changed from product preview to production data.....	All

PACKAGE OUTLINE DIMENSIONS

SOIC-8

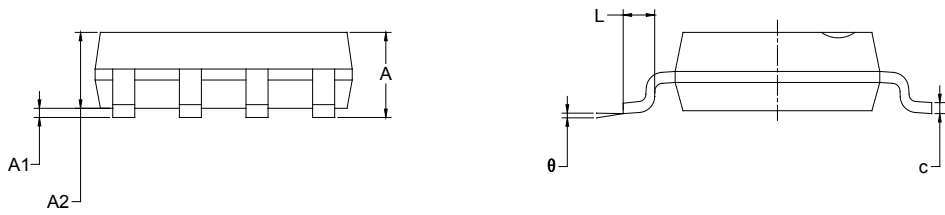
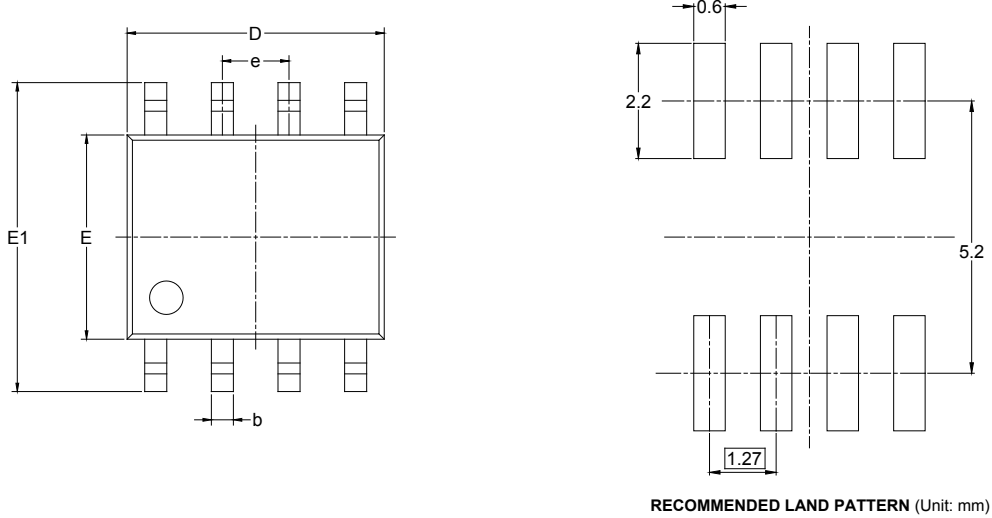

Symbol	Dimensions In Millimeters		Dimensions In Inches	
	MIN	MAX	MIN	MAX
A	1.350	1.750	0.053	0.069
A1	0.100	0.250	0.004	0.010
A2	1.350	1.550	0.053	0.061
b	0.330	0.510	0.013	0.020
c	0.170	0.250	0.006	0.010
D	4.700	5.100	0.185	0.200
E	3.800	4.000	0.150	0.157
E1	5.800	6.200	0.228	0.244
e	1.27 BSC		0.050 BSC	
L	0.400	1.270	0.016	0.050
θ	0°	8°	0°	8°

PACKAGE OUTLINE DIMENSIONS

MSOP-8



RECOMMENDED LAND PATTERN (Unit: mm)

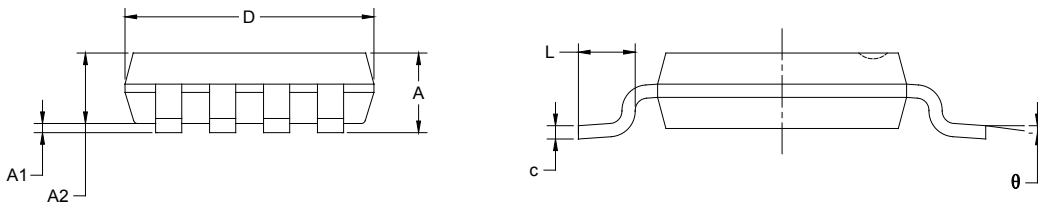

Symbol	Dimensions In Millimeters		Dimensions In Inches	
	MIN	MAX	MIN	MAX
A	0.820	1.100	0.032	0.043
A1	0.020	0.150	0.001	0.006
A2	0.750	0.950	0.030	0.037
b	0.250	0.380	0.010	0.015
c	0.090	0.230	0.004	0.009
D	2.900	3.100	0.114	0.122
E	2.900	3.100	0.114	0.122
E1	4.750	5.050	0.187	0.199
e	0.650 BSC		0.026 BSC	
L	0.400	0.800	0.016	0.031
θ	0°	6°	0°	6°

TAPE AND REEL INFORMATION

REEL DIMENSIONS

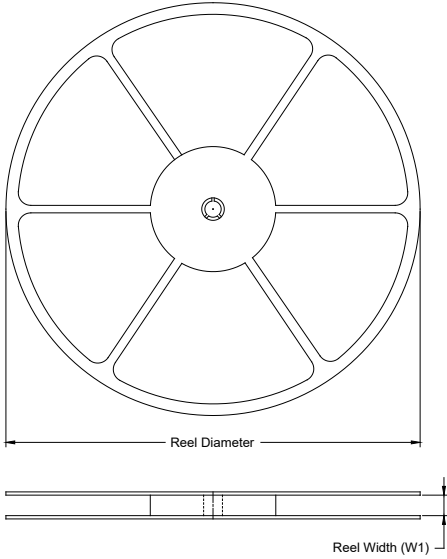

TAPE DIMENSIONS



NOTE: The picture is only for reference. Please make the object as the standard.

KEY PARAMETER LIST OF TAPE AND REEL

Package Type	Reel Diameter	Reel Width W1 (mm)	A0 (mm)	B0 (mm)	K0 (mm)	P0 (mm)	P1 (mm)	P2 (mm)	W (mm)	Pin1 Quadrant
SOIC-8	13"	12.4	6.40	5.40	2.10	4.0	8.0	2.0	12.0	Q1
MSOP-8	13"	12.4	5.20	3.30	1.50	4.0	8.0	2.0	12.0	Q1

DD0001

PACKAGE INFORMATION

CARTON BOX DIMENSIONS



NOTE: The picture is only for reference. Please make the object as the standard.

KEY PARAMETER LIST OF CARTON BOX

Reel Type	Length (mm)	Width (mm)	Height (mm)	Pizza/Carton
13"	386	280	370	5

DD0002