

Features

- 72 Watts Peak Pulse Power per Line (tp=8/20 μ s)
- Protects Two I/O Lines and Vcc
- Low Clamping Voltage
- RoHS Compliant
- IEC Compatibility
 - IEC61000-4-2 (ESD) \pm 17kV (air), \pm 14kV (contact)
 - IEC61000-4-4 (EFT) 40A (5/50 η s)
 - IEC61000-4-5 (LIGHTING) 4A (8/20 μ s)

Dimensions SOT-553

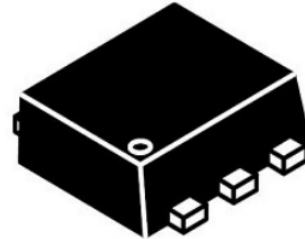

Applications

- USB Port Protection
- HDMI/DVI Port Protection
- Digital Sensor Input Protection
- Industrial Controls
- LVDS Protection
- Automotive Applications

Pin Configuration

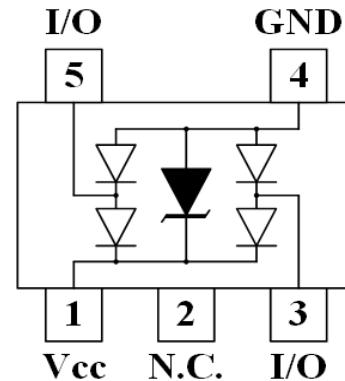

Mechanical Characteristics

- Package: SOT-553
- Molding Compound Flammability Rating : UL 94V-0
- Weight 3 Milligrams (Approximate)
- Quantity Per Reel : 3,000pcs
- Reel Size : 7 inch
- Lead Finish : Lead Free
- Device Marking: UD

Absolute Maximum Ratings (Tamb=25°C unless otherwise specified)

Parameter	Symbol	Value	Unit
Peak Pulse Power (8/20 μ s)	Ppp	72	W
ESD per IEC 61000-4-2 (Air)	VESD	\pm 17	KV
ESD per IEC 61000-4-2 (Contact)		\pm 14	
Operating Temperature Range	TJ	-40 to +125	°C
Storage Temperature Range	TSTJ	-55 to +150	°C

Electrical Characteristics (TA=25°C unless otherwise specified)

Symbol	Parameter	Conditions	Min	Typ	Max	Unit
VRWM	Reverse Working Peak Voltage				5	V
VBR	Reverse Breakdown Voltage	IT = 1mA	6			V
IR	Reverse Leakage Current	VRWM = 5V			1	μA
VC	Clamping Voltage	IPP = 1 A (8/20μs)			9.8	V
VC	Clamping Voltage	IPP = 4 A (8/20μs)			18	V
CJ	Capacitance	VR = 0V, f = 1MHz		0.7		pF

Typic Application Schematic

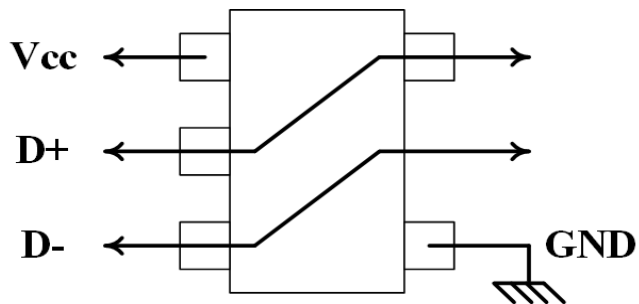

Characteristic Curves

Figure 1. 8 x 20 μ s Waveform

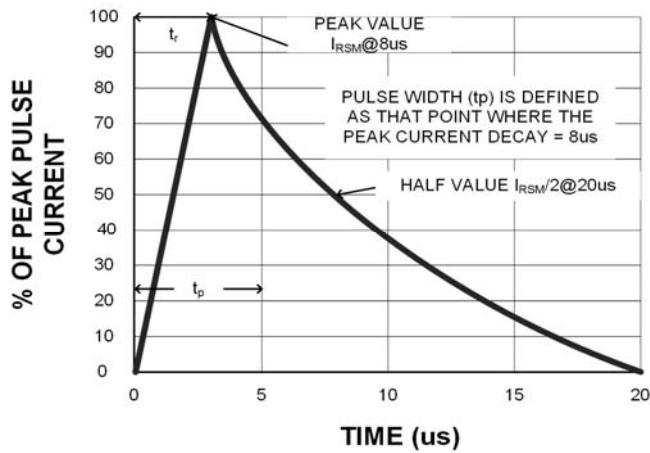

Figure 2. Power Derating Curve

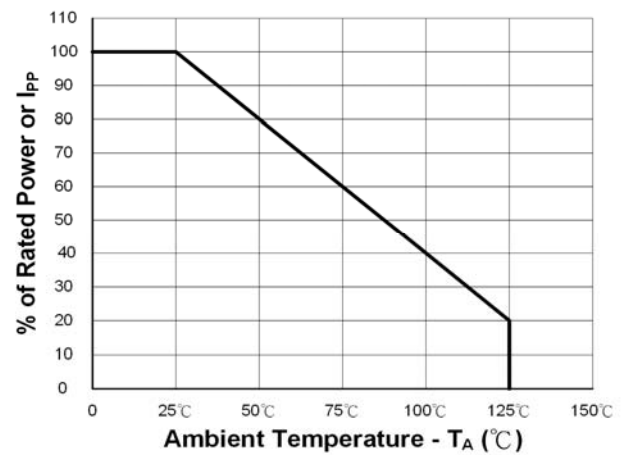
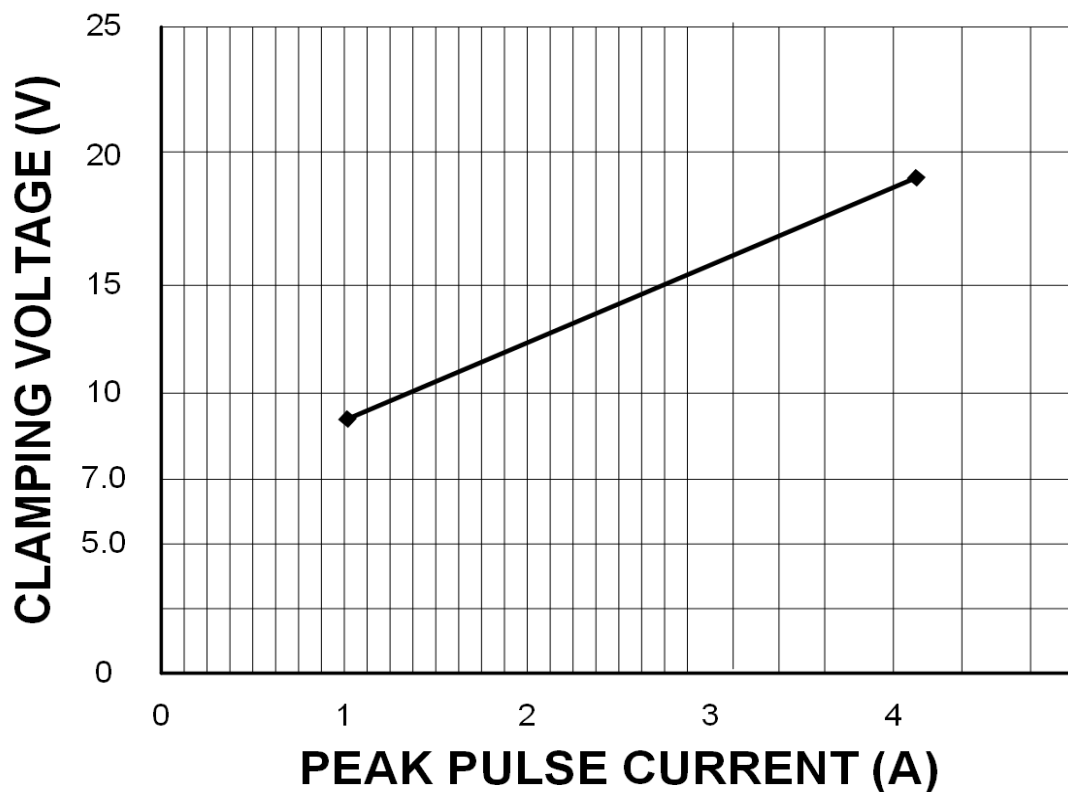
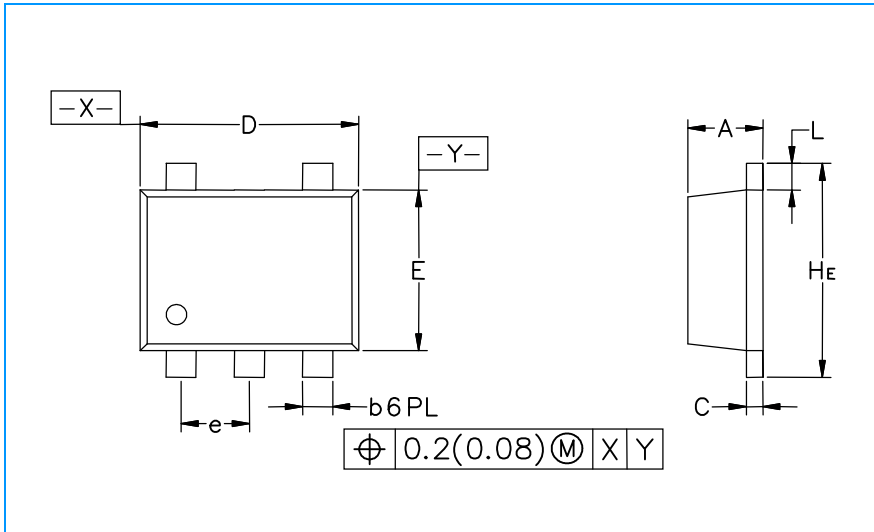

Figure 3. Clamping Voltage vs. Peak Pulse Current ($t_p=8/20 \mu$ s)



SOT-553 Package Outline & Dimensions



Symbol	Inches			Millimeters		
	Min.	Nom.	Max.	Min.	Nom.	Max.
A	0.020	0.021	0.023	0.50	0.55	0.60
b	0.007	0.009	0.011	0.17	0.22	0.27
C	0.003	0.005	0.007	0.08	0.12	0.18
D	0.059	0.062	0.066	1.50	1.60	1.70
E	0.043	0.047	0.051	1.10	1.20	1.30
e	0.02 BSC			0.5 BSC		
L	0.004	0.008	0.012	0.10	0.20	0.30
HE	0.059	0.062	0.067	1.50	1.60	1.70

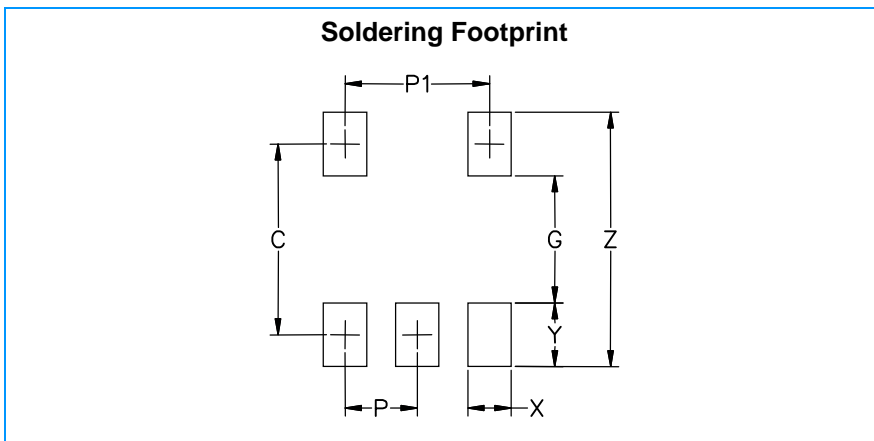

Symbol	Inches	Millimeters
C	0.0531	1.35
G	0.0354	0.90
P	0.0197	0.50
P1	0.0394	1.0
X	0.0118	0.30
Y	0.0177	0.45
Z	0.0709	1.80