

# LBSS138LT1G

## S-LBSS138LT1G

Power MOSFET

200 mA, 50V N-Channel SOT-23

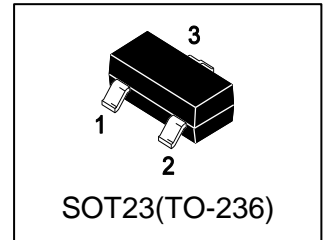

### 1. FEATURES

- We declare that the material of product compliance with RoHS requirements and Halogen Free.
- S- prefix for automotive and other applications requiring unique site and control change requirements; AEC-Q101 qualified and PPAP capable.
- Low threshold voltage ( $V_{GS(th)}$ ): 0.5V...1.5V) makes it ideal for low voltage applications.

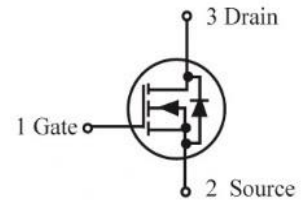

### 2. DEVICE MARKING AND ORDERING INFORMATION

Device	Marking	Shipping
LBSS138LT1G	J1	3000/Tape&Reel
LBSS138LT3G	J1	10000/Tape&Reel

### 3. MAXIMUM RATINGS( $T_a = 25^\circ\text{C}$ )

Parameter	Symbol	Limits	Unit
Drain-Source Voltage	VDSS	50	V
Gate-to-Source Voltage – Continuous	VGS	$\pm 20$	V
Drain Current			mA
– Continuous $T_A = 25^\circ\text{C}$	ID	200	
– Pulsed ( $t_p \leq 10\mu\text{s}$ )	IDM	800	

### 4. THERMAL CHARACTERISTICS

Parameter	Symbol	Limits	Unit
Total Device Dissipation, FR-5 Board (Note 1) @ $T_A = 25^\circ\text{C}$ Derate above $25^\circ\text{C}$	PD	225	mW
		1.8	mW/ $^\circ\text{C}$
Thermal Resistance, Junction-to-Ambient(Note 1)	ROJA	556	$^\circ\text{C}/\text{W}$
Junction and Storage temperature	$T_J, T_{stg}$	$-55 \sim +150$	$^\circ\text{C}$
Maximum Lead Temperature for Solde Purposes, for 10 seconds	TL	260	$^\circ\text{C}$

1. FR-5 = 1.0×0.75×0.062 in.

**5. ELECTRICAL CHARACTERISTICS (Ta= 25°C)**
**OFF CHARACTERISTICS**

Characteristic	Symbol	Min.	Typ.	Max.	Unit
Drain–Source Breakdown Voltage (VGS = 0, ID = 250μA)	VBRDSS	50	-	-	V
Zero Gate Voltage Drain Current (VGS = 0, VDS = 25 V) (VGS = 0, VDS = 50 V)	IDSS	- -	- -	0.1 0.5	μA
Gate–Body Leakage Current, Forward (VGS = 20 V)	IGSSF	-	-	0.1	μA
Gate–Body Leakage Current, Reverse (VGS = - 20 V)	IGSSR	-	-	-0.1	μA

**ON CHARACTERISTICS (Note 2)**

Gate Threshold Voltage (VDS = VGS, ID = 1.0mA)	VGS(th)	0.5	-	1.5	V
Static Drain–Source On–State Resistance (VGS = 2.75 V, ID < 200 mA, TA = -40°C to +85°C) (VGS = 5.0 V, ID = 200 mA)	RDS(on)	- -	5.6 -	10 3.5	Ohms
Forward Transconductance (VDS = 25 V, ID = 200 mA, f = 1.0 kHz)	gfs	100	-	-	mS

**DYNAMIC CHARACTERISTICS**

Input Capacitance (VDS = 25 V, VGS = 0, f = 1.0 MHz)	Ciss	-	40	50	pF
Output Capacitance (VDS = 25 V, VGS = 0, f = 1.0 MHz)	Coss	-	12	25	pF
Reverse Transfer Capacitance (VDS = 25 V, VGS = 0, f = 1.0 MHz)	Crss	-	3.5	5.0	pF

**SWITCHING CHARACTERISTICS**

Turn-On Delay Time	(VDD = 30 V , ID =200 mA)	td(on)	-	-	20	ns
Turn-Off Delay Time		td(off)	-	-	20	

 2.Pulse Test: Pulse Width  $\leq 300 \mu\text{s}$ , Duty Cycle  $\leq 2.0\%$ .

**6. ELECTRICAL CHARACTERISTICS CURVES**

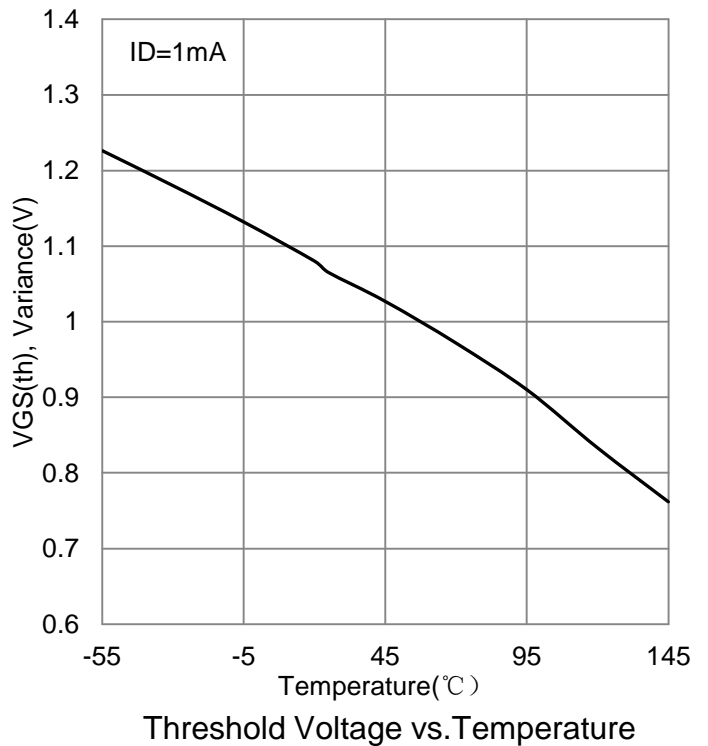
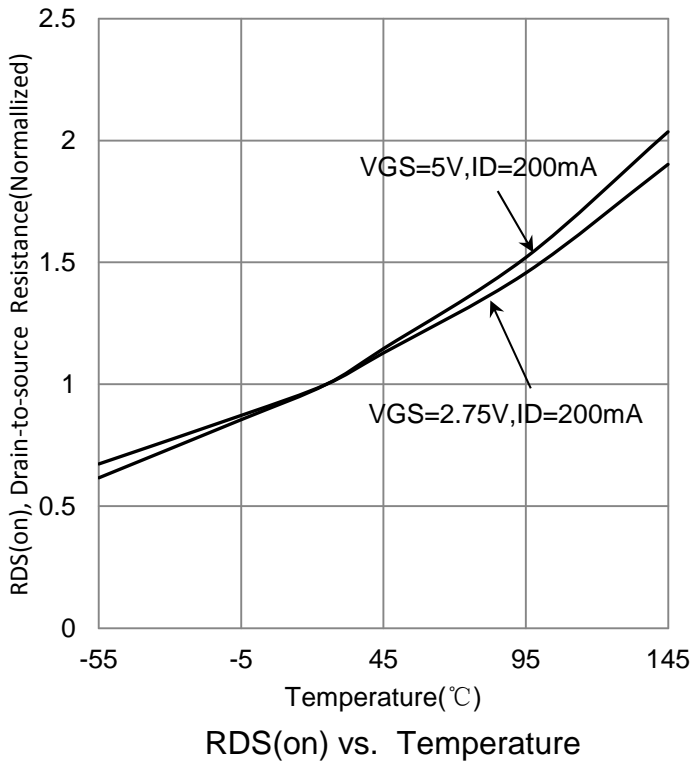
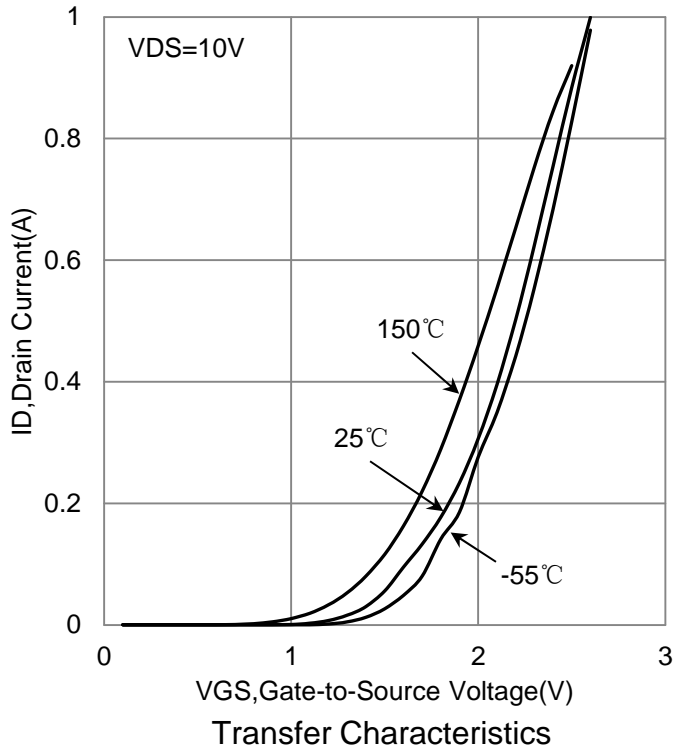
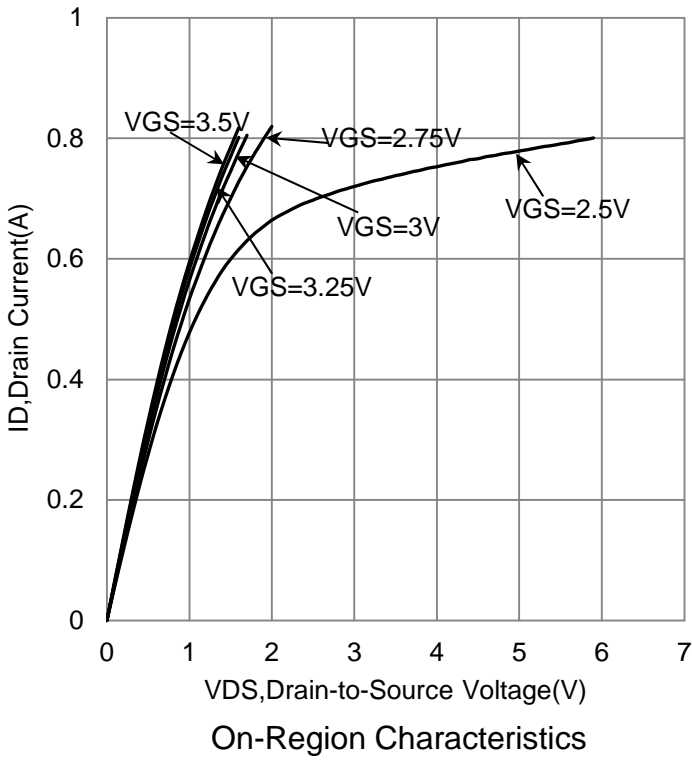

**6.ELECTRICAL CHARACTERISTICS CURVES(Con.)**

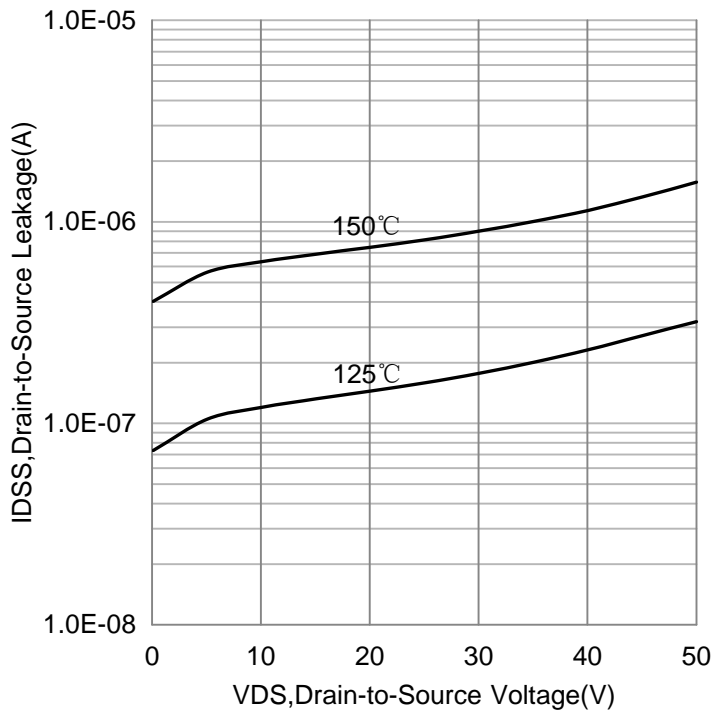

**IDSS vs. VDS**

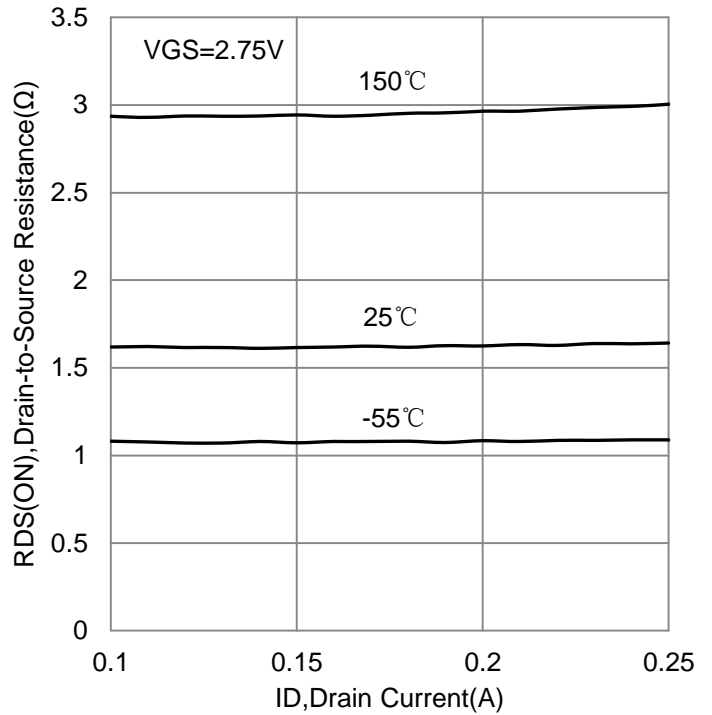

**RDS(on) vs. ID**

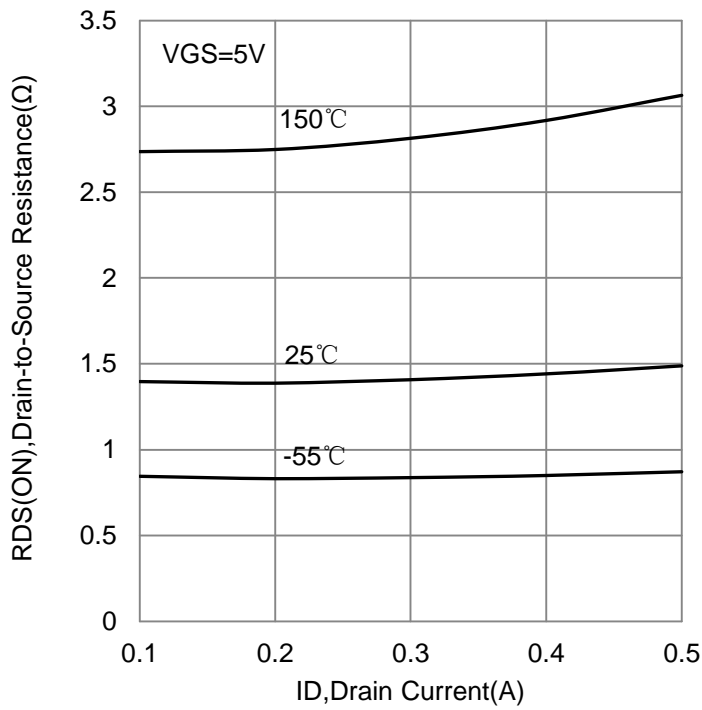

**RDS(on) vs. ID**

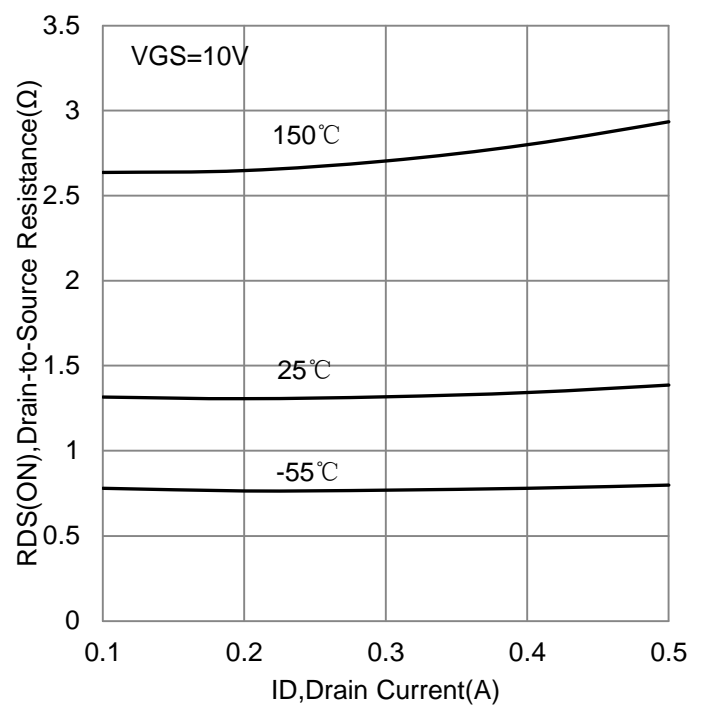

**RDS(on) vs. ID**

**6.ELECTRICAL CHARACTERISTICS CURVES(Con.)**

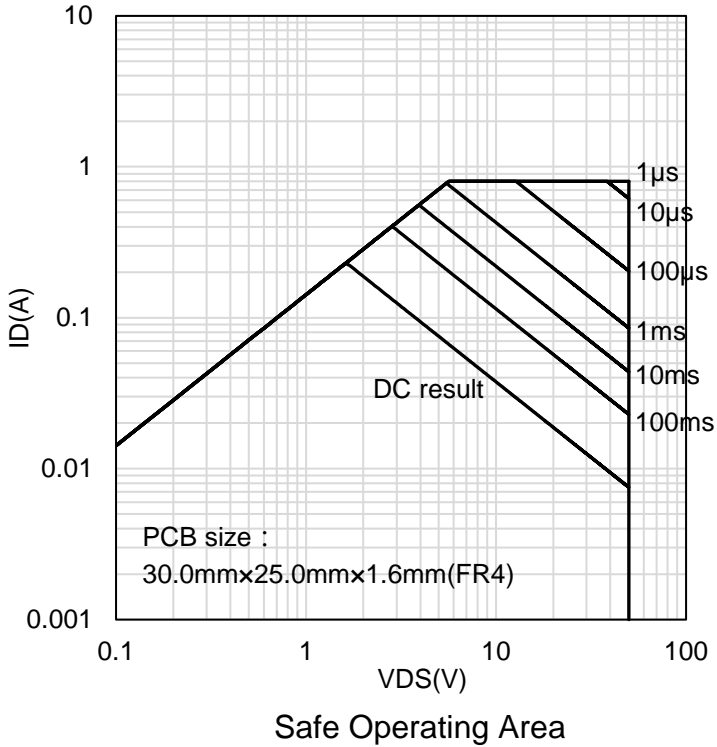
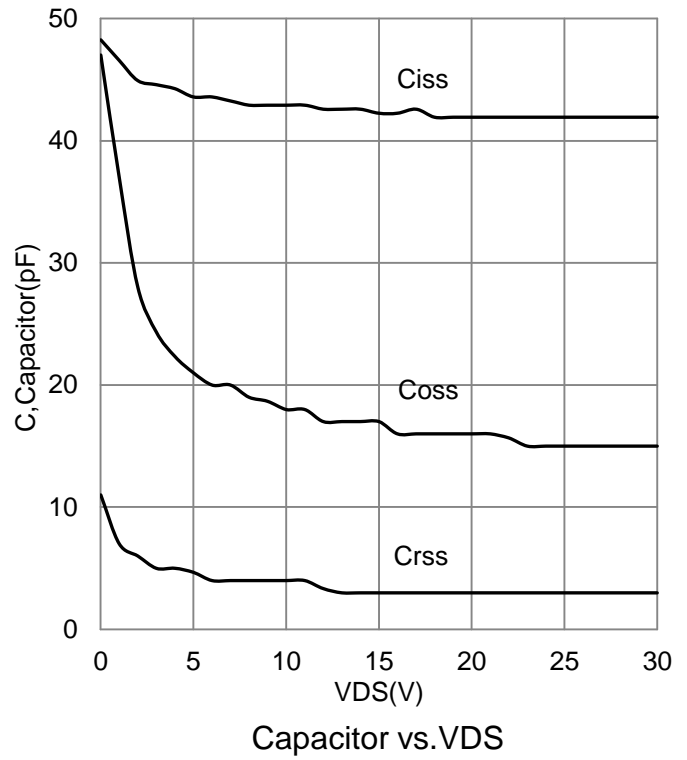
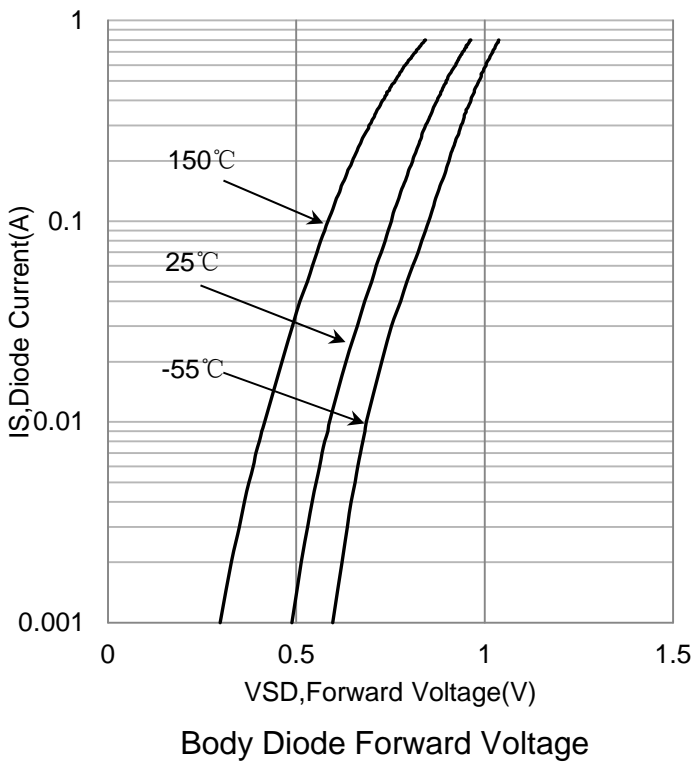

**7.OUTLINE AND DIMENSIONS**

Notes:

1. DIMENSIONING AND TOLERANCING PER ANSI Y14.5M, 1982.
2. CONTROLLING DIMENSION: MILLIMETERS.
3. MAXIMUM LEAD THICKNESS INCLUDES LEAD FINISH. MINIMUM LEAD THICKNESS IS THE MINIMUM THICKNESS OF BASE MATERIAL.
4. DIMENSIONS D AND E DO NOT INCLUDE MOLD FLASH, PROTRUSIONS OR GATE BURRS.

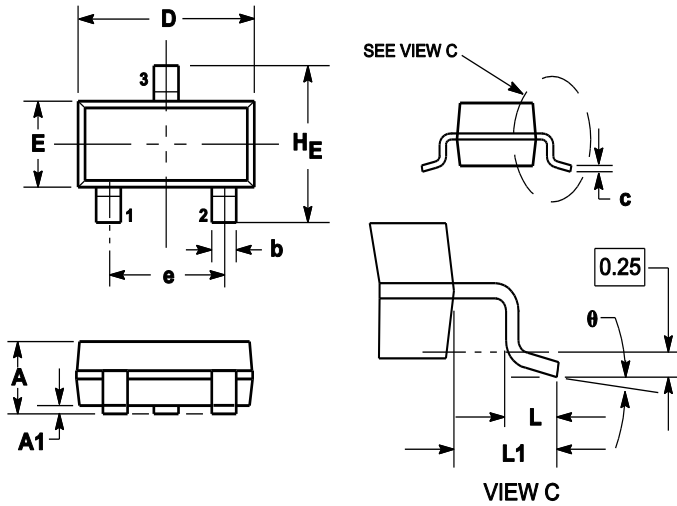

DIM	MILLIMETERS			INCHES		
	MIN	NOM	MAX	MIN	NOM	MAX
A	0.89	1	1.11	0.035	0.04	0.044
A1	0.01	0.06	0.1	0.001	0.002	0.004
b	0.37	0.44	0.5	0.015	0.018	0.02
c	0.09	0.13	0.18	0.003	0.005	0.007
D	2.80	2.9	3.04	0.11	0.114	0.12
E	1.20	1.3	1.4	0.047	0.051	0.055
e	1.78	1.9	2.04	0.07	0.075	0.081
L	0.10	0.2	0.3	0.004	0.008	0.012
L1	0.35	0.54	0.69	0.014	0.021	0.029
HE	2.10	2.4	2.64	0.083	0.094	0.104
θ	0°	---	10°	0°	---	10°

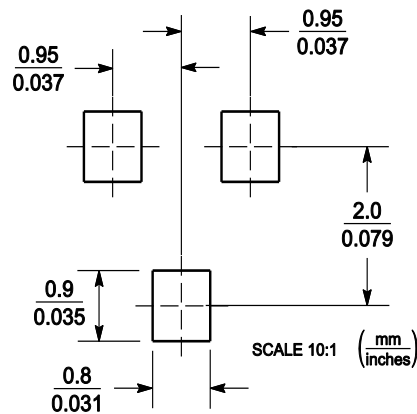
**8.SOLDERING FOOTPRINT**

## **DISCLAIMER**

- Curve guarantee in the specification. The curve of test items with electric parameter is used as quality guarantee. The curve of test items without electric parameter is used as reference only.
- Before you use our Products for new Project, you are requested to carefully read this document and fully understand its contents. LRC shall not be in any way responsible or liable for failure, malfunction or accident arising from the use of any LRC's Products against warning, caution or note contained in this document.
- All information contained in this document is current as of the issuing date and subject to change without any prior notice. Before purchasing or using LRC's Products, please confirm the latest information with a LRC sales representative.