

# LN2330ELT1G

## N-Channel 20V Enhancement Mode MOSFET

### 1. FEATURES

- Low Gate Threshold Voltage
- Fast Switching Speed
- Gate-Source ESD Protected
- We declare that the material of product are Halogen Free and compliance with RoHS requirements.

### 2. APPLICATIONS

- Battery Management Application
- Power Management Functions
- DC-DC Converters

### 3. ORDERING INFORMATION

Device	Marking	Shipping
LN2330ELT1G	N9E	3000/Tape&Reel
LN2330ELT3G	N9E	10000/Tape&Reel

### 4. MAXIMUM RATINGS(Ta = 25°C unless otherwise stated)

Parameter	Symbol	Limits	Unit
Drain-to-Source Voltage	VDSS	20	V
Gate-to-Source Voltage	VGS	± 10	V
Continuous Drain Current	ID	6.5	A
Avalanche Current(L=0.1mH)	IAS	14	A
Avalanche energy(L=0.1mH)	EAS	9.8	mJ

### 5. THERMAL CHARACTERISTICS

Parameter	Symbol	Limits	Unit
Maximum Power Dissipation	PD	0.9	W
Thermal Resistance, Junction-to-Ambient(Note 1)	RθJA	140	°C/W
Junction and Storage temperature	TJ, Tstg	-55~+150	°C

1. 1-in<sup>2</sup> 2oz Cu PCB board.

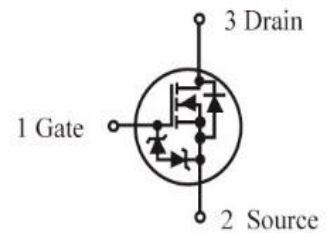
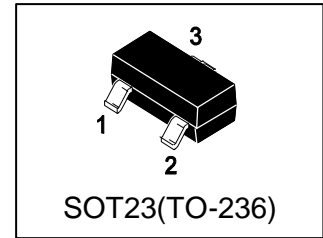

### 6. ELECTRICAL CHARACTERISTICS

Characteristic	Symbol	Min.	Typ.	Max.	Unit
Static					
Drain-Source Breakdown Voltage (VGS =0V, ID =250μA)	V(BR)DSS	20	-	-	V
Gate Threshold Voltage (VDS =VGS , ID =250μA)	VGS(th)	0.45	0.7	1	V
Gate Leakage Current (VDS =0V, VGS =± 10V)	IGSS	-	-	±10	μA
Zero Gate Voltage Drain Current (VDS =20V, VGS =0V )	IDSS	-	-	1	μA
Drain-Source On-Resistance(Note 2) (VGS =4.5V, ID = 6A) (VGS =2.5V, ID = 5A)	RDS(ON)	- -	- -	30 36	mΩ
Diode Forward Voltage (ISD = 0.5 A, VGS = 0 V)	VSD	-	0.7	1.3	V
Dynamic(Note 2)					
Total Gate Charge	Qg	-	10.5	-	nC
Gate-Source Charge	Qgs	-	1.7	-	
Gate-Drain Charge	Qgd	-	3	-	
Input Capacitance	Ciss	-	754	-	pF
Output Capacitance	Coss	-	123	-	
Reverse Transfer Capacitance	Crss	-	114	-	
Turn-On Delay Time	td(on)	-	5	-	ns
Turn-On Rise Time	tr	-	3.9	-	
Turn-Off Delay Time	td(off)	-	22	-	
Turn-Off Fall Time	tf	-	9	-	
Gate-Resistance (VGS = 0 V, VDS=0V,f=1MHz)	Rg	-	0.8	-	Ω

2. Pulse test; pulse width ≤ 300us, duty cycle ≤ 2%

**7. ELECTRICAL CHARACTERISTICS CURVES**

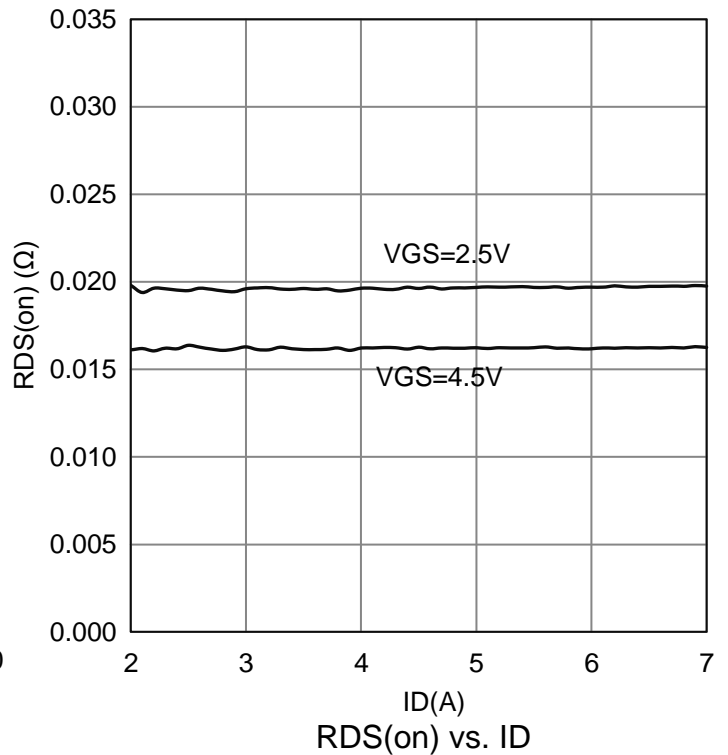
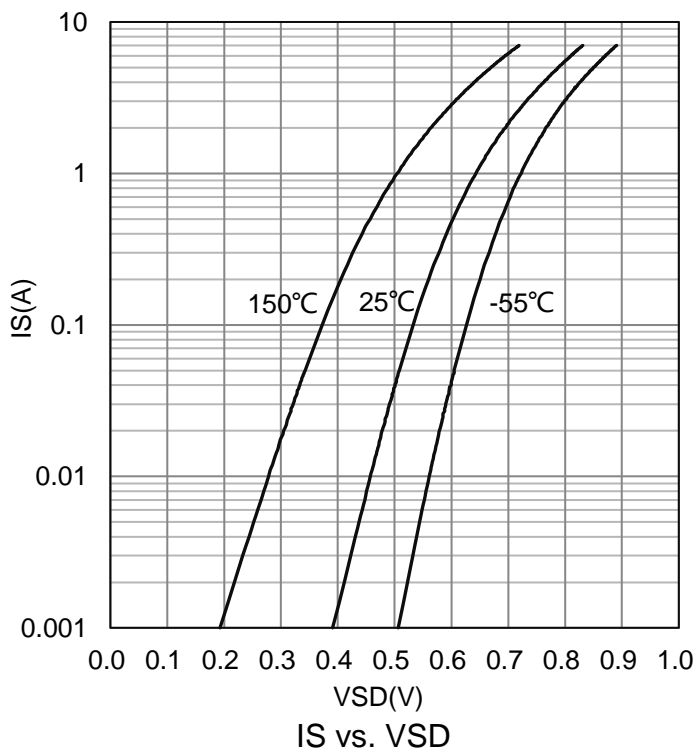
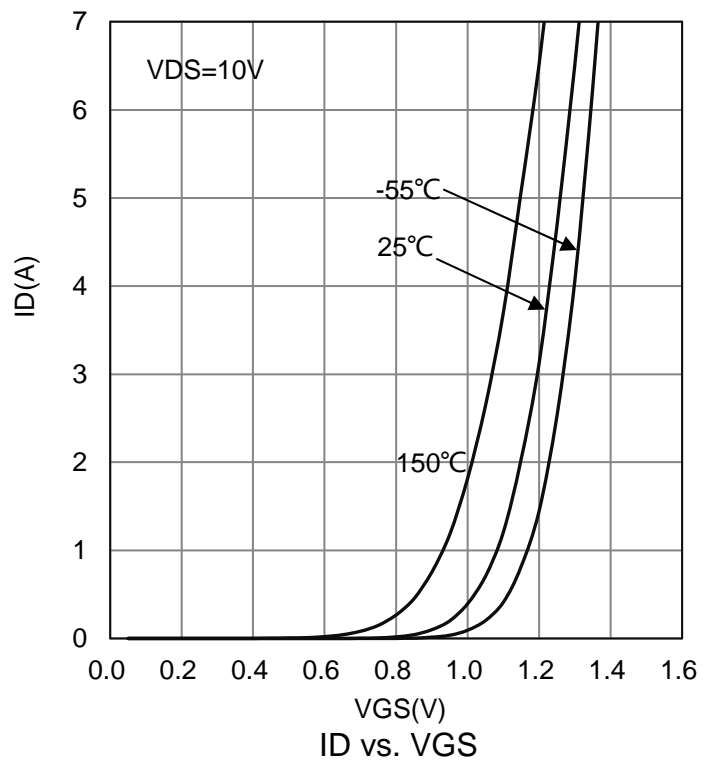
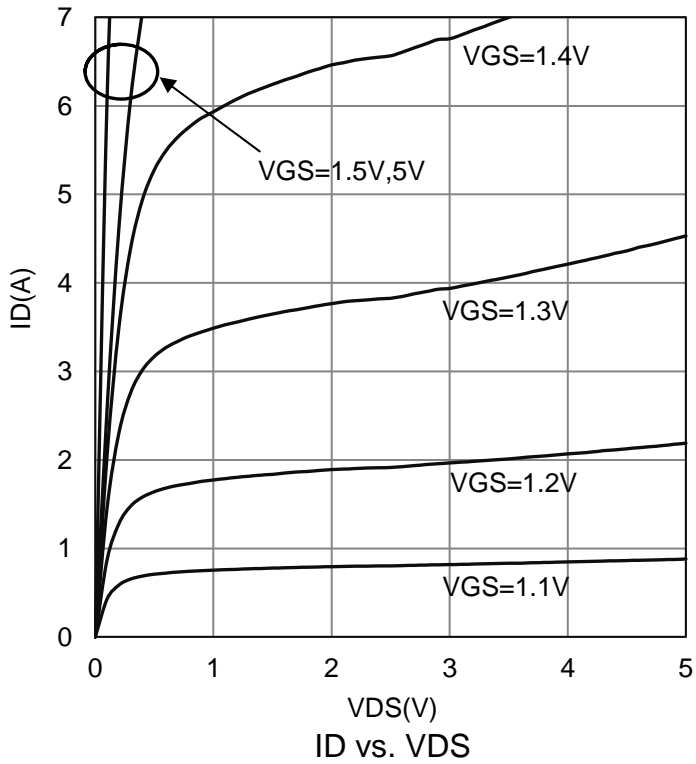

**7. ELECTRICAL CHARACTERISTICS CURVES(Con.)**

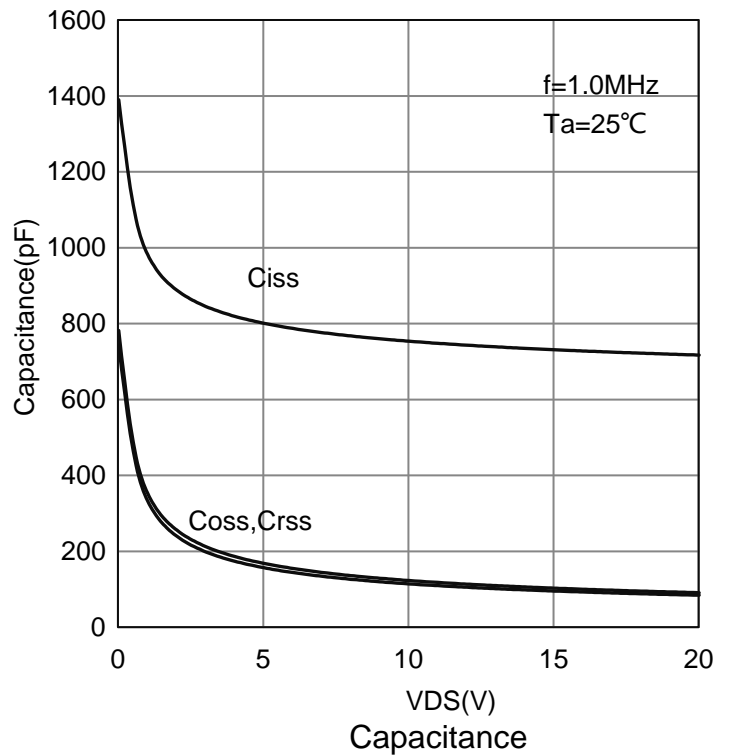
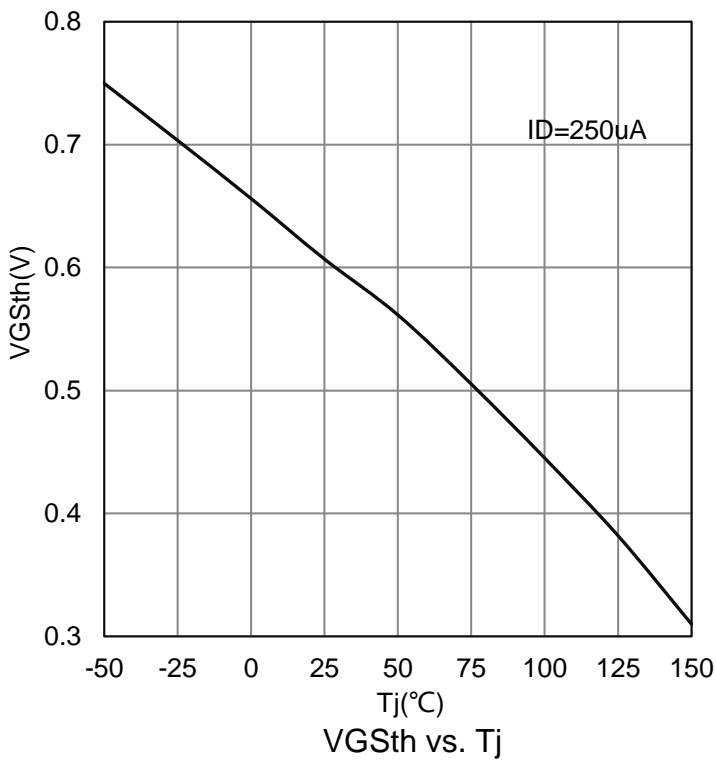
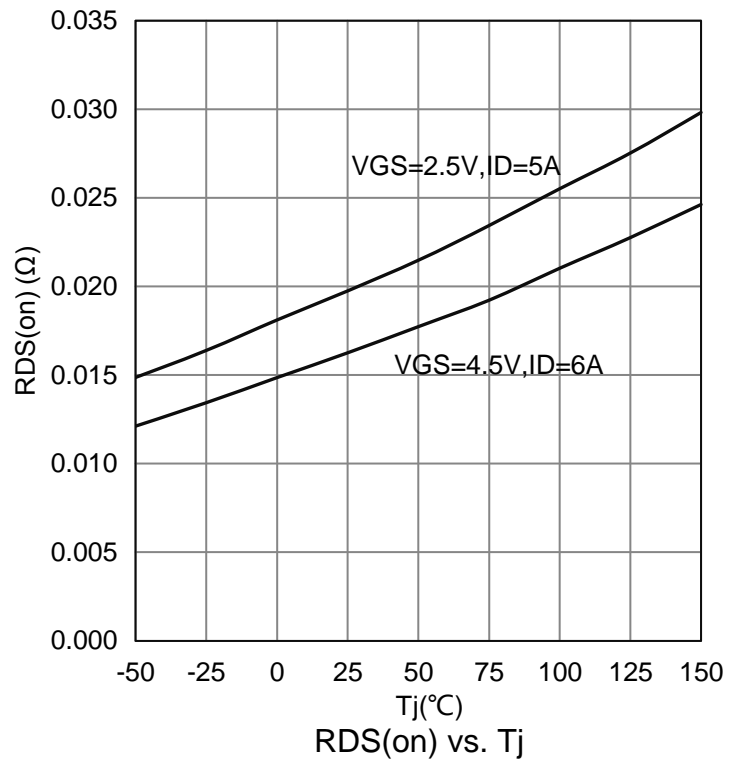
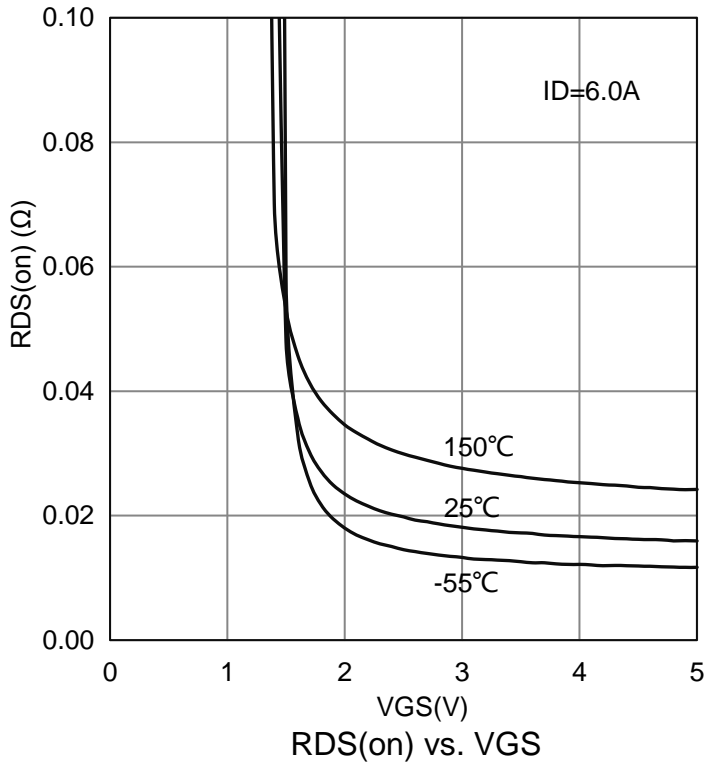

### 8. OUTLINE AND DIMENSIONS

Notes:

1. DIMENSIONING AND TOLERANCING PER ANSI Y14.5M, 1982.
2. CONTROLLING DIMENSION: MILLIMETERS.
3. MAXIMUM LEAD THICKNESS INCLUDES LEAD FINISH. MINIMUM LEAD THICKNESS IS THE MINIMUM THICKNESS OF BASE MATERIAL.
4. DIMENSIONS D AND E DO NOT INCLUDE MOLD FLASH, PROTRUSIONS OR GATE BURRS.

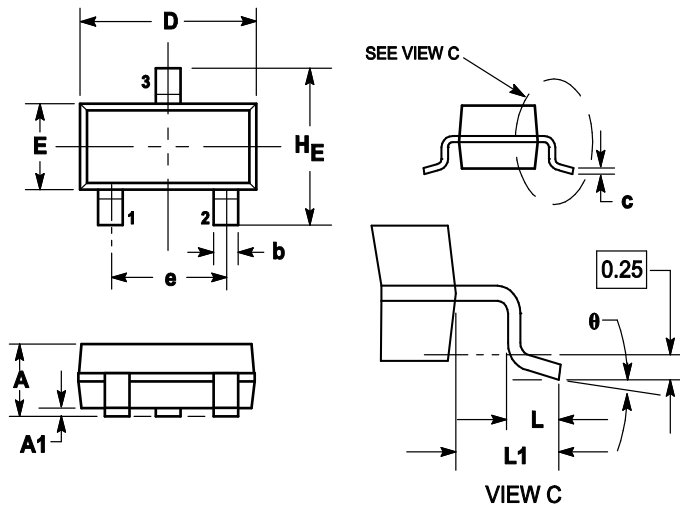

DIM	MILLIMETERS			INCHES		
	MIN	NOM	MAX	MIN	NOM	MAX
A	0.89	1	1.11	0.035	0.04	0.044
A1	0.01	0.06	0.1	0.001	0.002	0.004
b	0.37	0.44	0.5	0.015	0.018	0.02
c	0.09	0.13	0.18	0.003	0.005	0.007
D	2.80	2.9	3.04	0.11	0.114	0.12
E	1.20	1.3	1.4	0.047	0.051	0.055
e	1.78	1.9	2.04	0.07	0.075	0.081
L	0.10	0.2	0.3	0.004	0.008	0.012
L1	0.35	0.54	0.69	0.014	0.021	0.029
HE	2.10	2.4	2.64	0.083	0.094	0.104
θ	0°	---	10°	0°	---	10°

### 9. SOLDERING FOOTPRINT

