

# LP3416DT2AG

## 30V P-Channel Power MOSFET

### 1. FEATURES

- $V_{DS} = -30\text{ V}$ .  
 $R_{DS(ON)} \leq 25\text{ m}\Omega$ ,  $V_{GS@-10\text{V}}$ .  
 $R_{DS(ON)} \leq 37\text{ m}\Omega$ ,  $V_{GS@-4.5\text{V}}$ .
- Low thermal impedance.
- Fast switching speed.
- We declare that the material of product are Halogen Free and compliance with RoHS requirements.

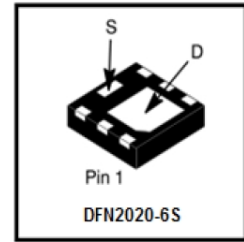

### 2. APPLICATIONS

- DC/DC Conversion
- Power Routing
- Load Switch

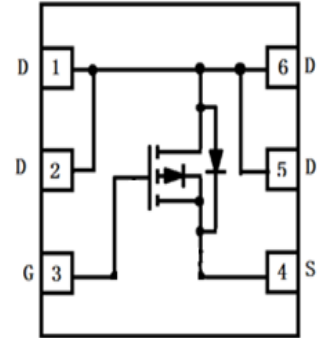

### 3. ORDERING INFORMATION

Device	Marking	Shipping
LP3416DT2AG	P6S	4000/Tape&Reel

### 4. MAXIMUM RATINGS( $T_a = 25^\circ\text{C}$ unless otherwise stated)

Parameter	Symbol	Limits	Unit
Drain-to-Source Voltage	$V_{DS}$	-30	V
Gate-to-Source Voltage	$V_{GS}$	$\pm 20$	V
Continuous Drain Current(Note 1)	ID	$T_A = 25^\circ\text{C}$	-8
		$T_A = 70^\circ\text{C}$	-7
Pulsed Drain Current (Note 2)	IDM	-32	A
Avalanche Current	IAS	20	A
Avalanche energy(L=0.1mH)	EAS	20	mJ
Power Dissipation(Note 1)	PD	$T_A = 25^\circ\text{C}$	2
		$T_A = 70^\circ\text{C}$	1.3
Operating Junction and Storage Temperature Range	$T_J, T_{STG}$	-55 ~ +150	$^\circ\text{C}$

### 5. THERMAL CHARACTERISTICS

Parameter	Symbol	Max	Unit
Thermal Resistance,Junction-to-Ambient(Note 1)	$R_{\theta JA}$	60	$^\circ\text{C/W}$
Thermal Resistance,Junction-to-Case	$R_{\theta JC}$	10	

- 1.Surface mounted on 1.5 x 1.5 FR4 board using 1 sq in pad, 2 oz Cu.
- 2.Pulse width limited by maximum junction temperature

## 6. ELECTRICAL CHARACTERISTICS

Characteristic	Symbol	Min.	Typ.	Max.	Unit	
<b>Static</b>						
Drain–Source Breakdown Voltage (VGS = 0 V , ID = -250 uA)	V(BR)DSS	-30	-	-	V	
Gate-Source Threshold Voltage (VDS = VGS , ID = -250 uA)	VGS(th)	-1	-	-2.5	V	
Gate-Body Leakage (VDS = 0 V, VGS = ± 20 V)	IGSS	-	-	± 100	nA	
Zero Gate Voltage Drain Current (VDS = -24 V, VGS = 0 V)	IDSS	-	-	-1	μA	
Drain-Source On-Resistance(Note 3) (VGS = -10V, ID = -5A) (VGS = -4.5V, ID = -3A)	RDS(on)	-	-	25 37	mΩ	
Diode Forward Voltage(Note 3) (IS = -1A, VGS = 0V)	VSD	-	-	-1.5	V	
<b>Dynamic</b>						
Total Gate Charge	(VDS = -15 V, VGS = -10 V, ID = -5 A)	Qg	-	25	-	nC
Gate-Source Charge		Qgs	-	3.8	-	
Gate-Drain Charge		Qgd	-	5	-	
Turn-On Delay Time	(VDS = -15 V, RL = 2 Ω, ID = -7.5 A, VGEN = -10 V, RGEN = 6 Ω)	td(on)	-	7.7	-	ns
Rise Time		tr	-	9.6	-	
Turn-Off Delay Time		td(off)	-	69	-	
Fall Time		tf	-	28	-	
Input Capacitance	(VDS = -15 V, VGS = 0 V, f = 1 MHz)	Ciss	-	1585	-	pF
Output Capacitance		Coss	-	173	-	
Reverse Transfer Capacitance		Crss	-	134	-	

3.Pulse test: PW ≤ 300us duty cycle ≤ 2%.

**7. ELECTRICAL CHARACTERISTICS CURVES**

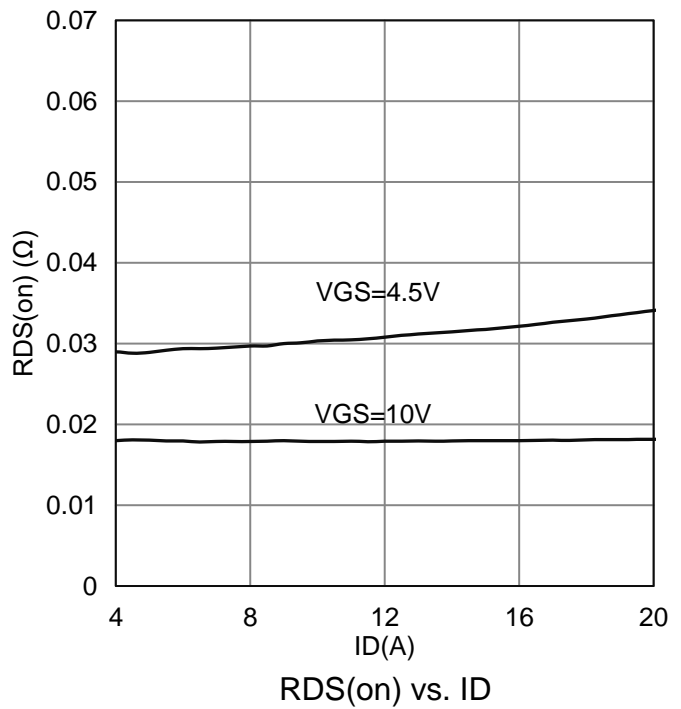
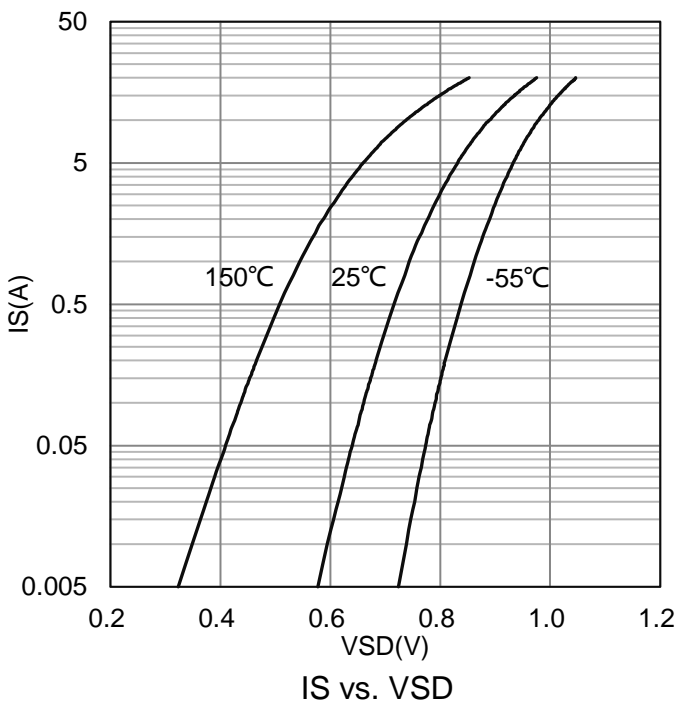
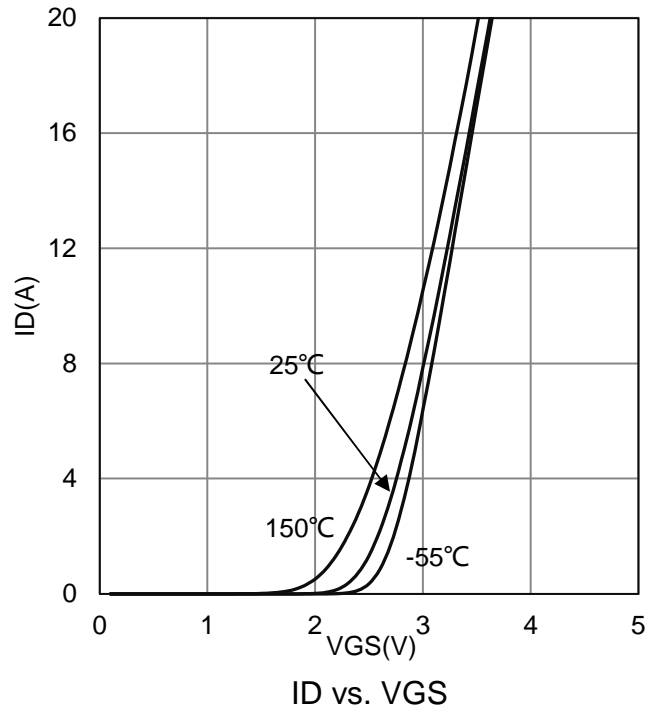
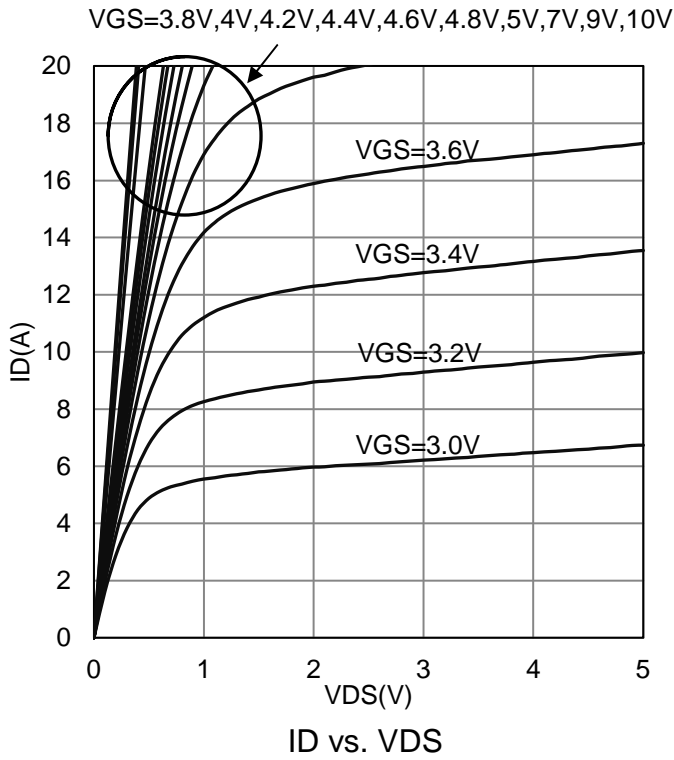

**7. ELECTRICAL CHARACTERISTICS CURVES(Con.)**

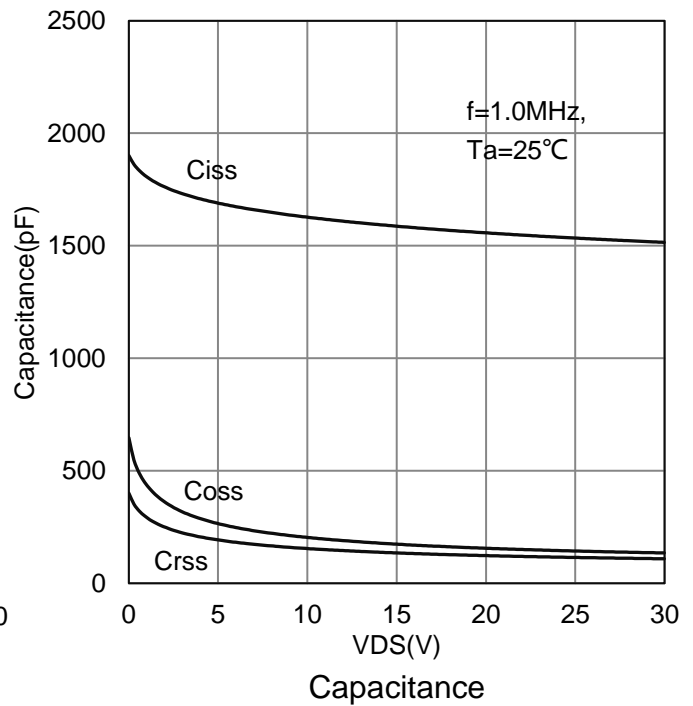
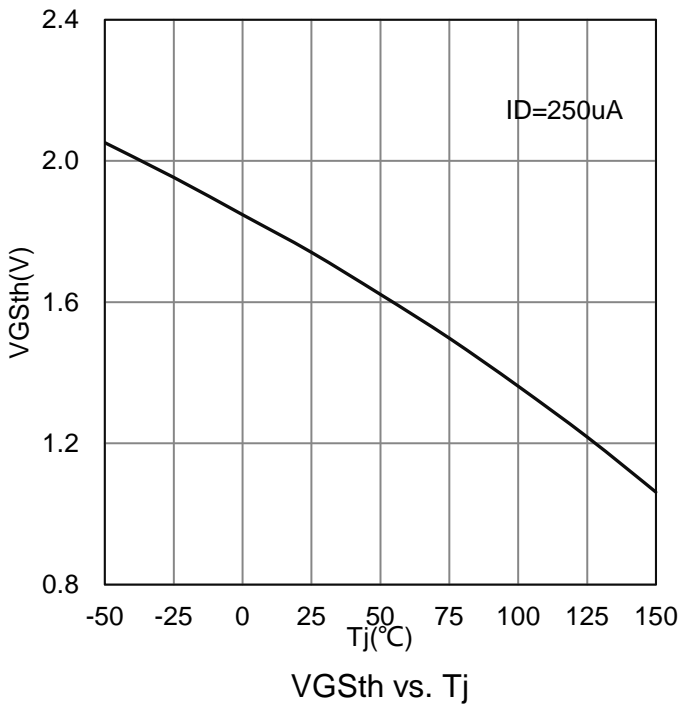
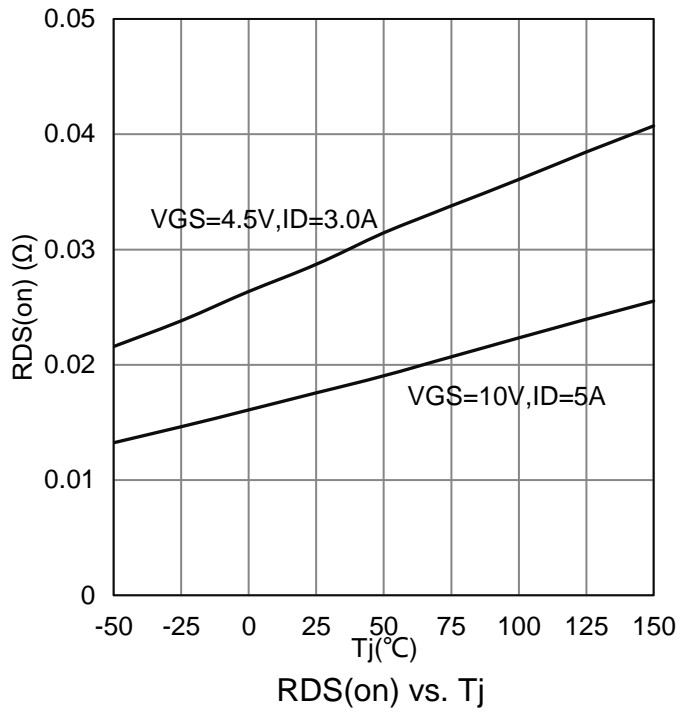
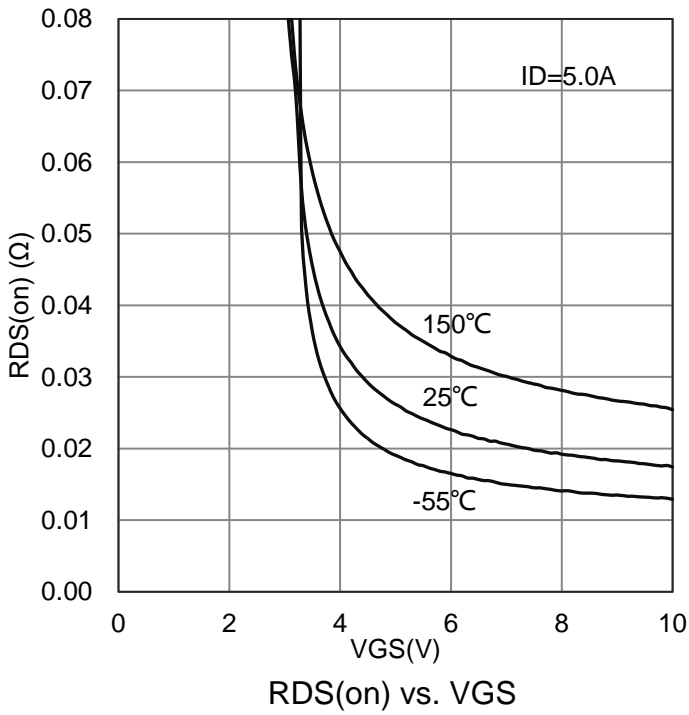

7. ELECTRICAL CHARACTERISTICS CURVES(Con.)

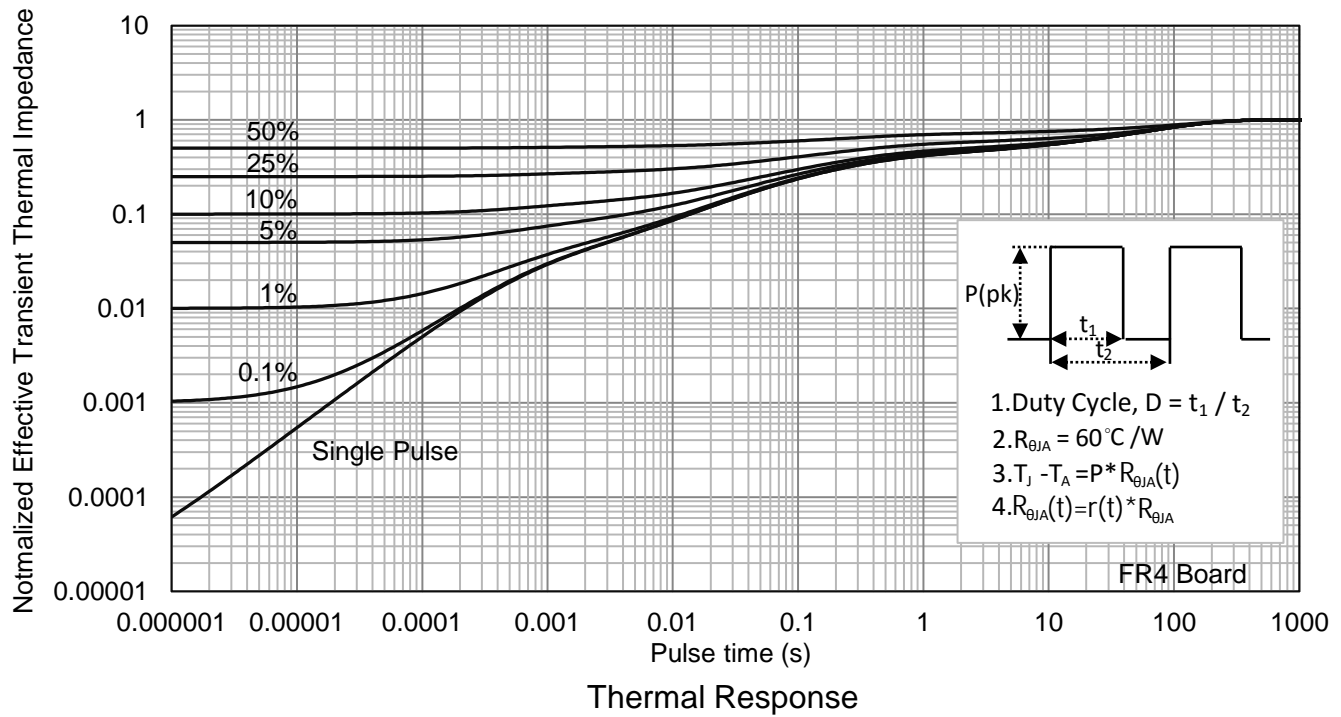
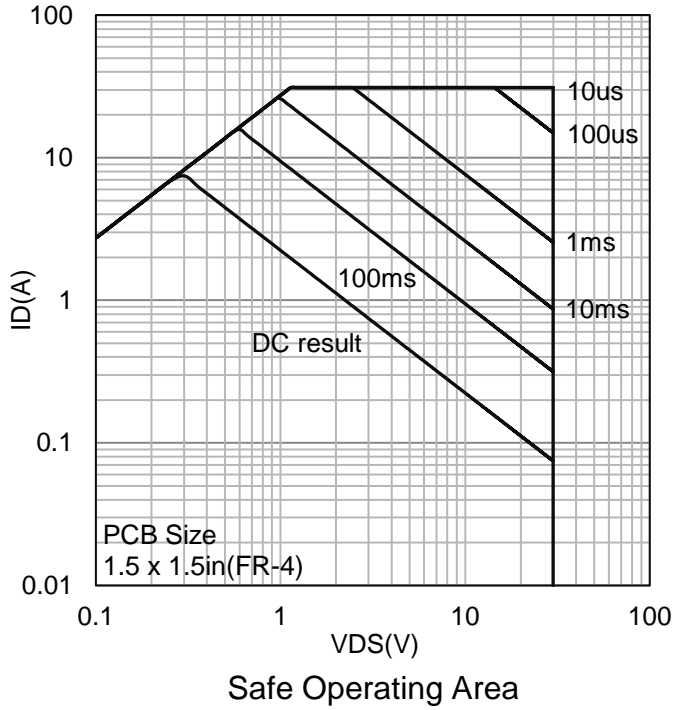

**8. OUTLINE AND DIMENSIONS**

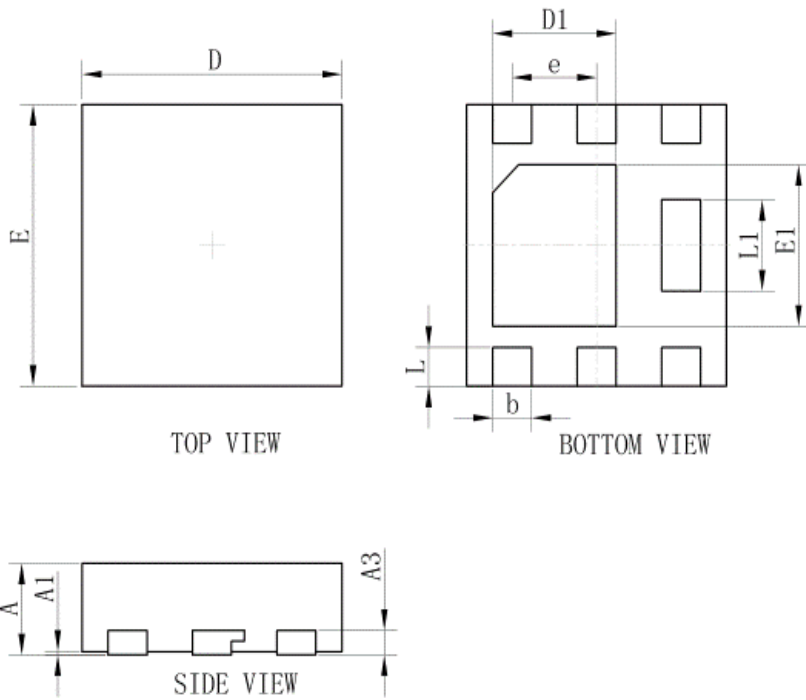

DFN2020-6S			
DIM	MIN	NOR	MAX
A	0.60	0.65	0.70
A1	0.01	0.03	0.05
b	0.25	0.30	0.35
D	1.95	2.00	2.05
E	1.95	2.00	2.05
e	0.65TYP.		
L	0.23	0.28	0.33
L1	0.60	0.65	0.70
D1	0.90	0.95	1.00
E1	1.10	1.15	1.20
A3	0.152REF		
All Dimensions in mm			

**9. SOLDERING FOOTPRINT**

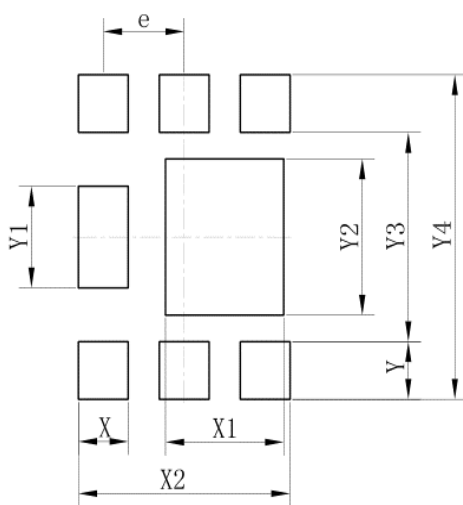

DFN2020-6S	
Dim	(mm)
X	0.40
X1	0.95
X2	1.70
e	0.65
Y	0.43
Y1	0.75
Y2	1.15
Y3	1.54
Y4	2.39

## **DISCLAIMER**

- Curve guarantee in the specification. The curve of test items with electric parameter is used as quality guarantee. The curve of test items without electric parameter is used as reference only.
- Before you use our Products for new Project, you are requested to carefully read this document and fully understand its contents. LRC shall not be in any way responsible or liable for failure, malfunction or accident arising from the use of any LRC's Products against warning, caution or note contained in this document.
- All information contained in this document is current as of the issuing date and subject to change without any prior notice. Before purchasing or using LRC's Products, please confirm the latest information with a LRC sales representative.