

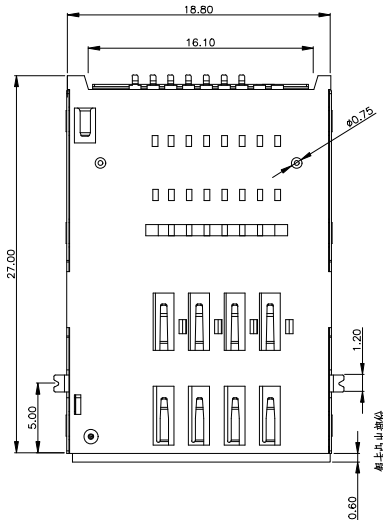

REV.	ECN NO OR DESCRIPTION	REVISED	DATE

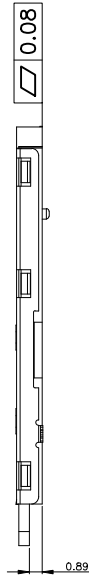

pin no.	name
C1	vcc of sim
C2	rst of sim
C3	clk of sim
C5	gnd of sim
C6	vpp of sim
C7	I/O of sim
C4/C8	n/a

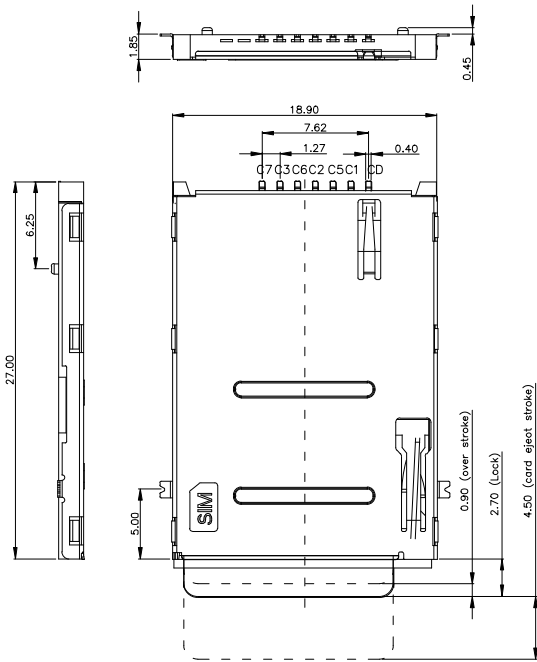
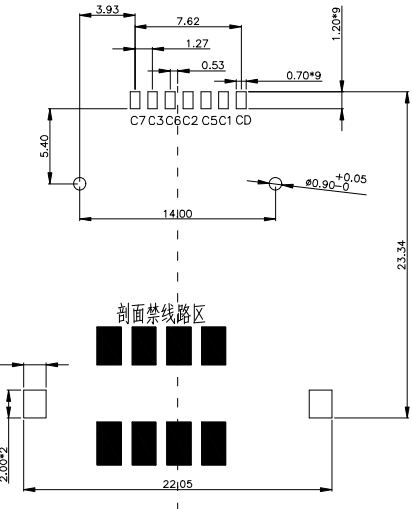
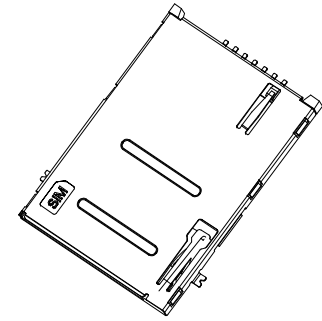
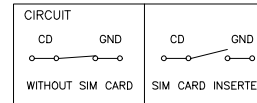

RECOMMENDED PCB LAYOUT
GENERAL TOLERANCE ±0.05

A

B

C

D

A

B

C

D

Notes:

- Material:
Housing:LCP Color:black(塑胶材质: LCP 94-V0 黑色)
Contact:Phosphor Bronze.(端子材质: 磷青铜)
SHELL:SUS (外壳材质: 不锈钢)
- All NI30u"Min Contact 1u",solder area Tin 30u/min(全部镀底30u", 接触点1u", 焊接处镀30u")
- shell Ni 30" min ,solder gold Flash (镀底30"u,焊接处镀金)

SPECIFICATION:

- DURABILITY: 5000 CYCLES MIN(寿命:5000次最小)
- CURRENT:0.5A (额定电流: 0.5Amps)
- VOLTAGE:40V MAX(额定电压: 40V最大)
- WITHSTANDING VOLTAGE:500V AC MIN.(UNMATED) (耐压: 500V AC最小)
- CONTACT RESISTANCE:30mΩ MAX.(端子接触电阻: 30mΩ最大)
- INSULATION RESISTANCE:1000MΩ MIN.(UNMATED) (绝缘电阻: 1000兆欧最小)
- OPERATING TEMPERATURE RANGE:-40.C TO +85.C (工作温度: -40度到+80度)
- ALL THE MATERIAL SHOULD COMPLY WITH THE ROHS (全部材质符合ROHS)

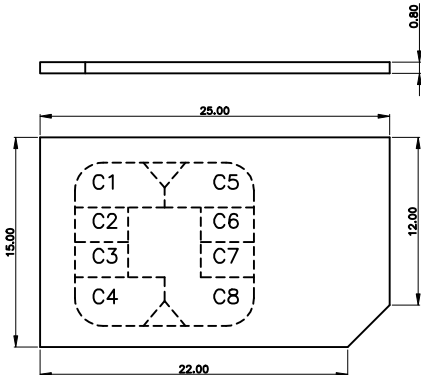
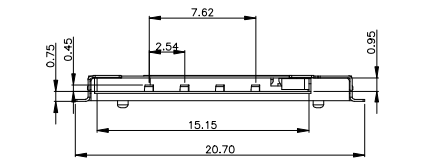

UNLESS OTHERWISE SPECIFIED TOLERANCES

DECIMALS:	ANGLES:
X : ±0.5	X : ±2°
X.X : ±0.20	X.X : ±1°
X.XX : ±0.10	



东莞市汉博电子科技有限公司
DONGGUAN HANBO TECHNOLOGY CO., LTD

TITLE	Mini SIM PUSH 6P+1P有左右开关后脚		
DWN	xiong	SIM-210	
CHKD	lee	SCALE:1:1	UNIT: mm
APVD	wang	SIZE: A4	SHEET:10F 1
			REV: A4

CUSTOMER COPY

1

2

3

4

5

6