

## Introduction

- Soft saturation.
- High current, low DCR, high efficiency.
- Very low acoustic noise and very low leakage flux noise.
- High reliability.
- 100% Lead(Pb)-Free and RoHS compliant.
- Operating temperature -55~+125°C(Including self - temperature rise)



## Applications

- Note PC power system, incl. IMVP-6
- DC/DC converter

## Dimensions (Unit: mm)

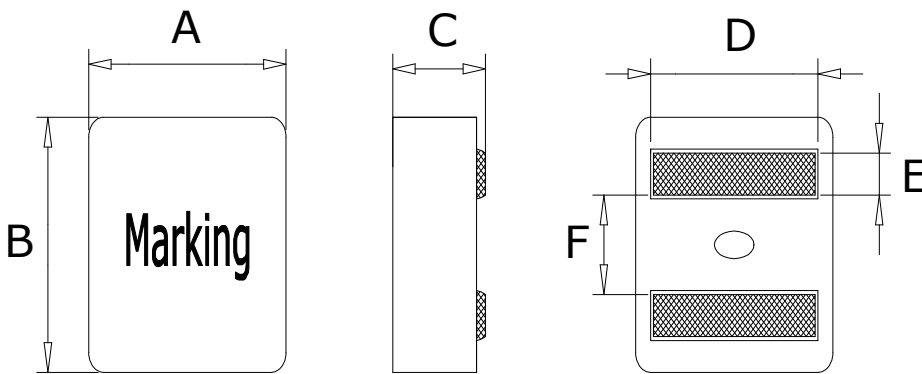

Code	Dimensions(mm)
A	4.1±0.2
B	4.1±0.2
C	1.9±0.2
D	3.4±0.3
E	0.88±0.3
F	1.7±0.3

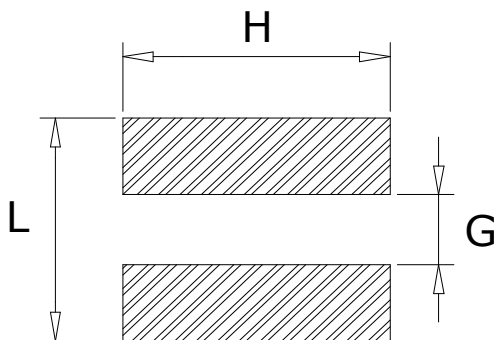

L	3.4ref
H	3.8ref
G	1.4ref

Recommend Land Pattern

Unit : mm

## Marking

Note : Using Ink for marking



Marking:

Example	Nominal Value
0.18 $\mu$ H	R18
1.2 $\mu$ H	1R2
4.5 $\mu$ H	4R5

## Structure and Components

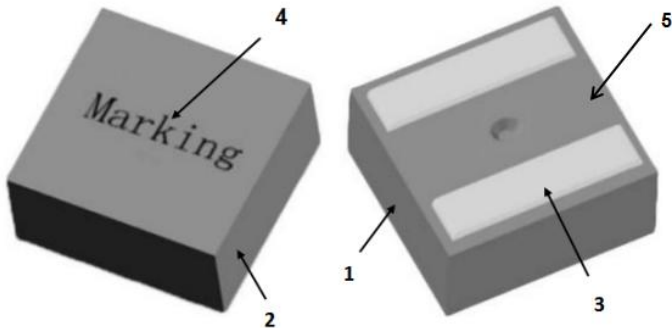

NO	Components	Material
1	CORE	Alloy Powder
2	WIRE	Polyester Wire or equivalent.
3	Clip	100% Pb free solder
4	Ink	Halogen-free ketone
5	paint	Epoxy resin

## Specification

Part No.	L0 ( $\mu$ H) $\pm$ 20 %	DCR (m $\Omega$ ) MAX	Isat (A)		I <sub>rms</sub> (A)Typ	
			Max	Typ	20°C rise	40°C rise
FEXL0420A-R10M	0.1	2.42	33	38	13.5	18
FEXL0420A-R22M	0.22	4.6	18.8	19.5	13.0	16.8
FEXL0420A-R36M	0.36	6.3	15	17	11	14.5
FEXL0420A-R40M	0.4	7.73	13.5	15.5	10	14
FEXL0420A-R47M	0.47	8.58	13	14.5	9	12.5
FEXL0420A-R56M	0.56	9.3	12.6	14	8.5	12
FEXL0420A-R60M	0.6	9.52	12.3	13.7	8.0	11.7
FEXL0420A-R72M	0.72	11.6	10.6	12	7.6	10.5
FEXL0420A-1R0M	1.0	14.6	8.8	9.6	6.8	9.6
FEXL0420A-1R2M	1.2	17.9	7.8	9	6.6	9.0
FEXL0420A-1R5M	1.5	23.5	7.4	8	5.8	7.6
FEXL0420A-1R8M	1.8	28	7	7.5	5.2	7
FEXL0420A-2R2M	2.2	38.7	6	6.5	4.6	5.6

### Notes:

1. Test frequency : L : 100KHz /0.1V;
2. All test in 25 °C temperature.
3. Testing Instrument:L:HP4285A,CH11025,CH3302,CH1320,CH1320S LCR METER / Rdc:CH16502, MICRO OHMMETER.
4. Heating Rating Current (I<sub>rms</sub>) will cause the coil temperature rise of 40°C approximately ( $\Delta$ t);
5. Saturation Current (Isat ) will cause L0 to drop 30% approximately.
6. The part temperature (ambient + temp rise) should not exceed 125°C under the worst case operating condition. Circuit design, component, PCB trace size and thickness airflow and other cooling provisions all could affect the part temperature. Part temperature should be verified in the end application.
7. Special inquiries besides the above common used types can be met on your requirement.



DCR Test

Mechanical Reliability		
Item	Specification and Requirement	Test Method
Solderability	1. No case deformation or change in visual 2. New solder coverage More than 95%	1.Preheat: 155℃±5℃ , 60S±2S 2.Tin: lead-free. 3.Temperature:240℃±5℃, flux 3.0S±0.5S.
Mechanical shock	1. No case deformation or change in visual 2. $\Delta L/L_0 \leq \pm 10\%$	1. Acceleration: 100G 2. Pulse time: 6ms 3. 3 times in each positive and negative direction of 3 mutual perpendicular directions
Mechanical vibration	1. No case deformation or change in visual 2. $\Delta L/L_0 \leq \pm 10\%$	1. Reflow: 2times 2. Frequency: 10HZ~50HZ~10HZ, 20 Min/Cycles 3. Amplitude: 1.52 mm±10% 4. Directions: X,Y,Z 5. Time: 12 cycle / direction
Endurance Reliability		
Item	Specification and Requirement	Test Method
Thermal Shock	Inductance change: Within $\pm 10\%$ Without distinct damage in visual	1. First -55℃ for 30 minutes, last 125℃ for 30 minutes as 1 cycle. Go through 1000 cycles. 2. Max transfer time is 3 minutes. 3. Measured at room temperature after placing for 24±2 hours
Humidity Resistance	Inductance change: Within $\pm 10\%$ Without distinct damage in visual	1.Reflow 2 times, 2.85℃±3℃,85%±3%RH,1000 hours 3.Measured at room temperature after placing for 24±2 hours
Low temperature storage	Inductance change: Within $\pm 10\%$ Without distinct damage in visual	1. Temperature: -55 ± 2℃ 2. Time: 1000 hours 3. Measured at room temperature after placing for 24±2 hours
High temperature storage	Inductance change: Within $\pm 10\%$ Without distinct damage in visual	1. Temperature: +125 ± 2℃ 2. Time: 1000 hours 3. Measured at room temperature after placing for 24±2 hours

## Recommended Soldering Technologies

### (1) Re-flowing Profile

Preheat condition: 150 ~200°C/60~120sec.

Allowed time above 217°C: 60~90sec.

Peak temp: 260°C

Max time at Peak temp: 10 sec.

Solder paste: Sn/3.0Ag/0.5Cu

Allowed Reflow time: 2x max

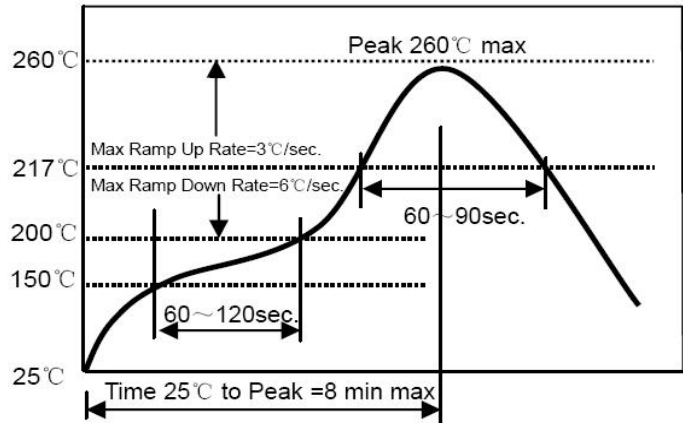

### (2) Iron Soldering Profile

Iron soldering power: Max. 30W

Pre-heating: 150°C/60sec.

Soldering Tip temperature: 350°C Max.

Soldering time: 3sec. Max.

Solder paste: Sn/3.0Ag/0.5Cu

Max.1 times for iron soldering

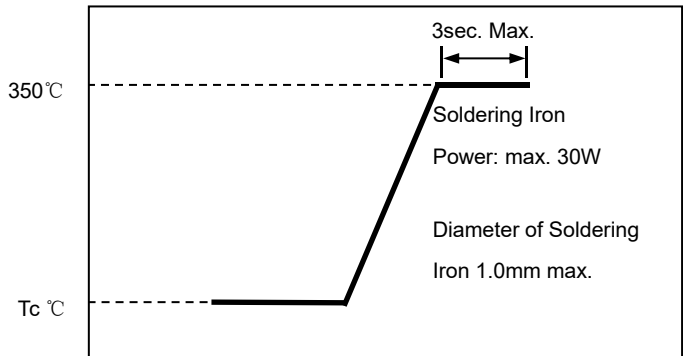

### Packaging Information

(1) Tape Packaging Dimensions (Unit: mm)

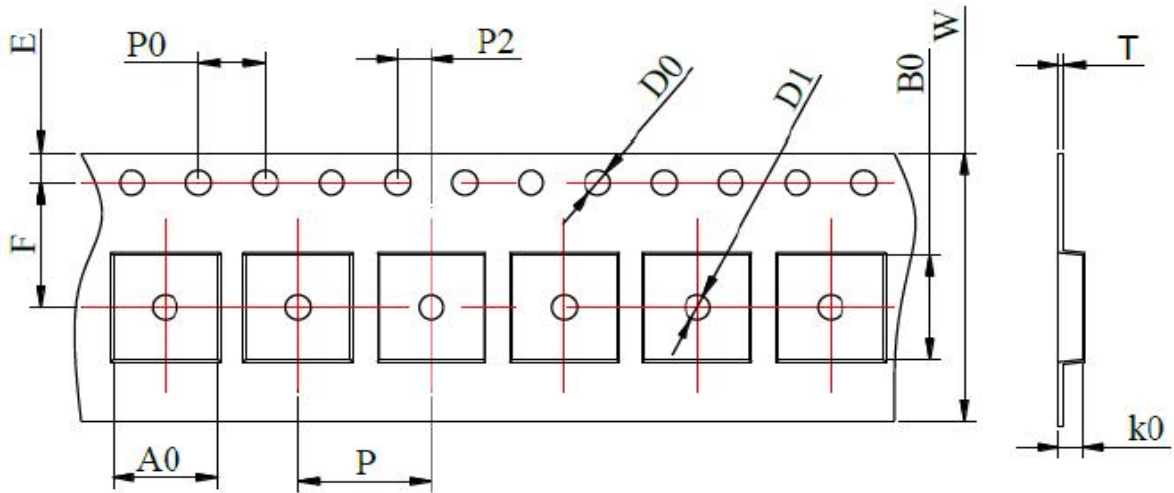

Tape dimensions (mm)											
W	P	P0	P2	D0	D1	T	A0	B0	K0	E	F
12 ±0.3	8 ±0.1	4 ±0.1	2 ±0.1	1.5 ±0.1	1.5 ±0.1	0.35 ±0.05	4.4 ±0.1	4.4 ±0.1	2.3 ±0.1	1.75 ±0.1	5.5 ±0.1

### Taping Drawings (UNIT:mm)

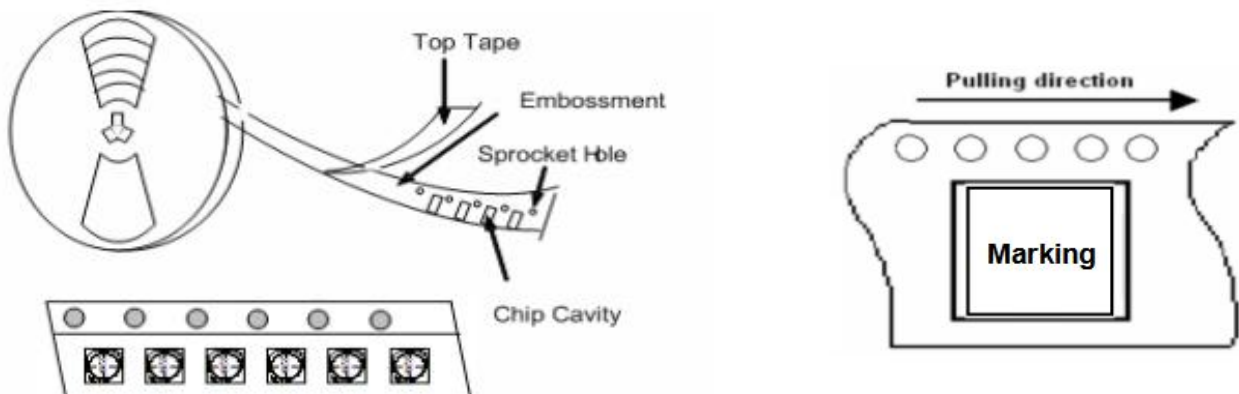

**(2) Reel Dimensions (Unit: mm)**

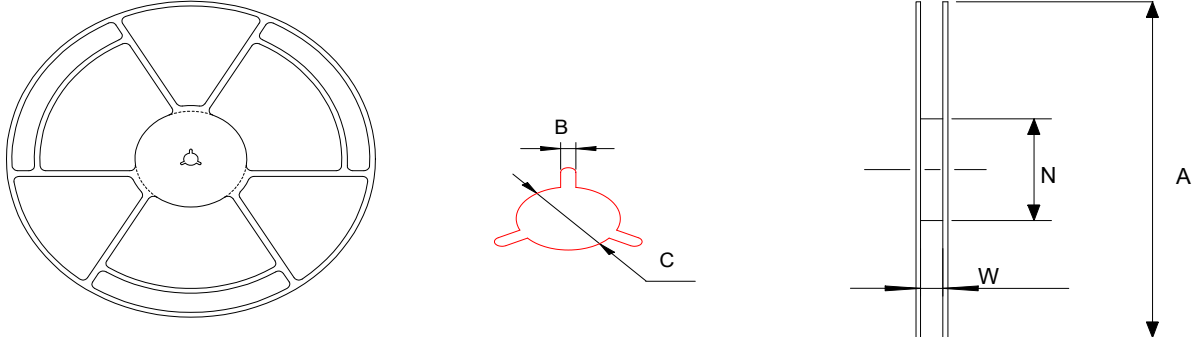

A	W	N	B	C
330+2.0	12.8±0.2	97±0.5	2.2+0.5	13.0±0.2

**(3) Packaging Quantity**

Standard Quantity		
Reel	Inner box	Carton box
3000 pcs / reel	4Reel / box (12000 pcs)	4 Middle boxes, (48,000 pcs)

**(4) Peel force of top cover tape**

The peel speed shall be about 300mm/minute

The peel force of top cover tape shall be between 0.1 to 1.3 N

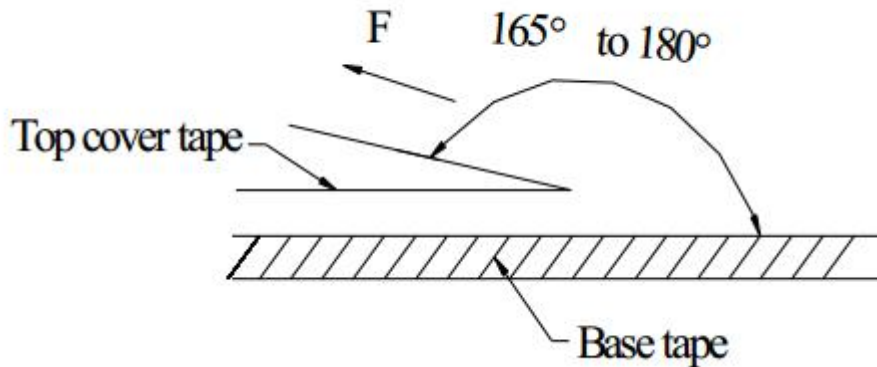

**(5) Reel Label**

Label on the reel

- Customer's part Number
- Lot Number
- Quantity
- date code

Shipping Label

- Customer's part Number
- Manufacturer's part Number
- Quantity
- date code

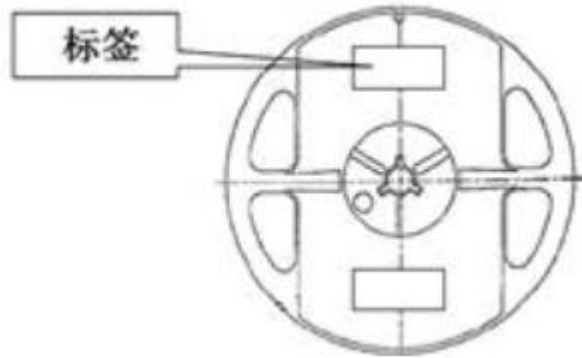

**(6) Inner Box**

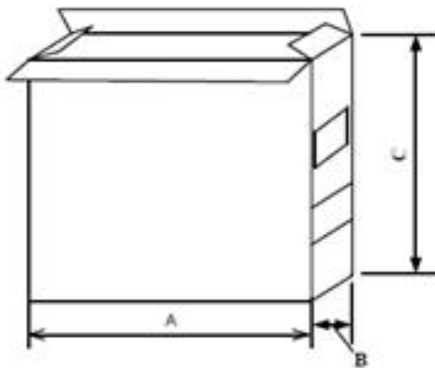

Packaging type	A (mm)	B (mm)	C (mm)
Inner box	335	70	340

**(7) Carton**

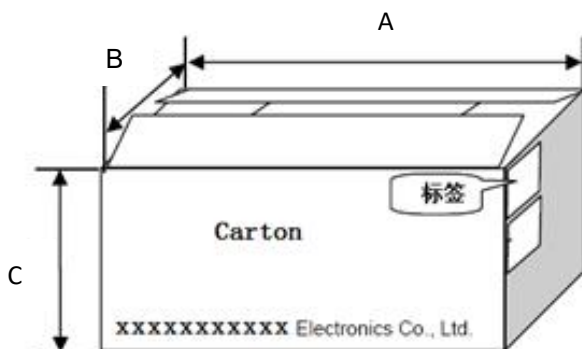

Packaging type	A (mm)	B (mm)	C (mm)
type	360	360	360



### Appearance criterion

#### 1、PAD residual powder、inner wire exposed、imprinting

The residual powder on both side of pad is norm and within following criteria are acceptable.

The imprinting mark below the part, are norm in manufacturing process and does not affect the function and it is acceptable.

Front lit imprinting is acceptable.

<b>a</b>	10% max of the length of pad.
<b>b</b>	5% of the area on one single pad.
<b>t</b>	0.08mm max.

Foreign materials on the product body is inevitable and accepted.

#### 2、Defects

Chip off is generated during molding and manufacturing process.

Chip off acceptance limits subjected to the product size.

Our current Defect limit is based on the IPC-A-610.

Some chip off does not impact the product function, see the IPC standard 1 & 2.

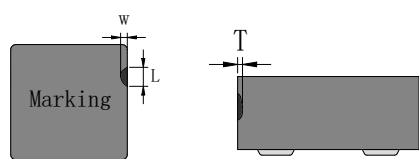

T	≤10% of the thickness	Each surface can only accept one minor chip off, and more than 3 chip off problems are not allowed on the same product.
W	≤10 % of the width	
L	≤10 % of the length	

Defects usually occur at the corners and edges of the product, There will be a slight defect black and rough, but not exposed copper, and does not affect the product performance and reliability.

#### 3、Crack

Production process of cracks appearing in the body is inevitable, some slight crack is caused because the molding, is not oxidized, crack on the product will not affect product performance.

We have done a reliability test of crack products, even if cracks is more than 0.13mm also will not affect the electrical properties of the product, crack limits as follows:

Severely crack: not acceptable. More obvious cracks extended from side to side.

Moderate crack: not acceptable. Very obvious and may result in powder come off and exposed of copper wire.

Slight wire expose: acceptable wire exposed during Press process.

Lead wire imprint: acceptable Turns of wires that close to the edge and imprint show.

Slight crack: acceptable.

Products from a slight crack in the baking process due to thermal expansion, and it is not obvious by visual inspection (Must not exceed the blue square area).

Cracks on the same side surface are not allowed to exceed 1/2 of the length of the side and the crack width cannot exceed 0.13mm, and only 1 crack is allowed on the same side.

Bottom cracks are not allowed to exceed 1/2 of the length (or width) of the corresponding body nor the Non-manufacturability swelling, and the crack width cannot be exceed 0.13mm, and less than 2 cracks are allowed and judged as good products.

Visible cracks and non-manufacturability bulging are not allowed on the front side.

#### 4、oxidation(rust)

the contains iron composite, although the resin has a protective effect of oxidation, but there will be small amount of product that may occur oxidation, The oxidation area of each surface is allowed to be about 25% (in the case of non-reliability test), it is recommend that customer use this product in humidity controlled environment. The basic steps should be to protect the surface oxidation, including the sealed packages to PCB mount inductors. To avoid the adverse effects caused by oxidation, Oxidation occurs at the surface only allows the internal oxidation is not allowed, oxidized surface will not affect the reliability of the product.

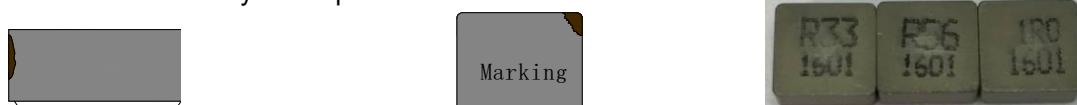

4sides slightly oxidized side: Acceptable

Top and bottom slightly oxidized side: Acceptable

Spray printing effect : can be accepted if recognizable

Visual inspection: Examination with the naked eye, to distinguish from more technical modes of analysis employing tools or apparatus.