

THIS DOCUMENT IS SUBJECT TO CHANGE WITHOUT NOTICE. IT IS CONFIDENTIAL AND A PROPERTY OF Amphenol LTW. DISCLOSURE TO THIRD PARTY HAS TO BE AUTHORIZED BY Amphenol LTW.

REV.	ECN NO.	DATE	SIGN	DESCRIPTION
A		2016/11/23	Victor Hung	Change Rev.01 To Rev.A
B	CI91299	2019/07/26	Jane	Update Ordering Information
C	CI92023	2019/11/20	Vicky	△C X4

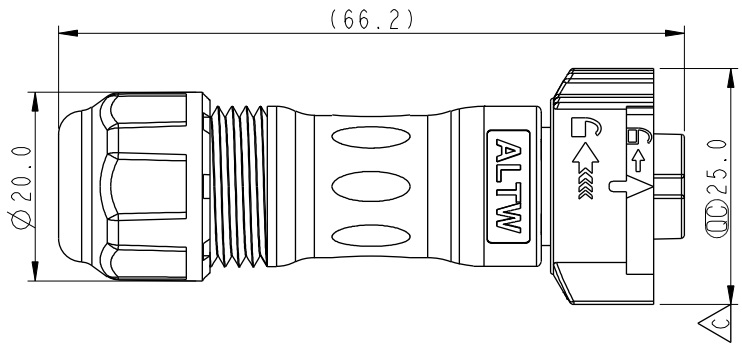
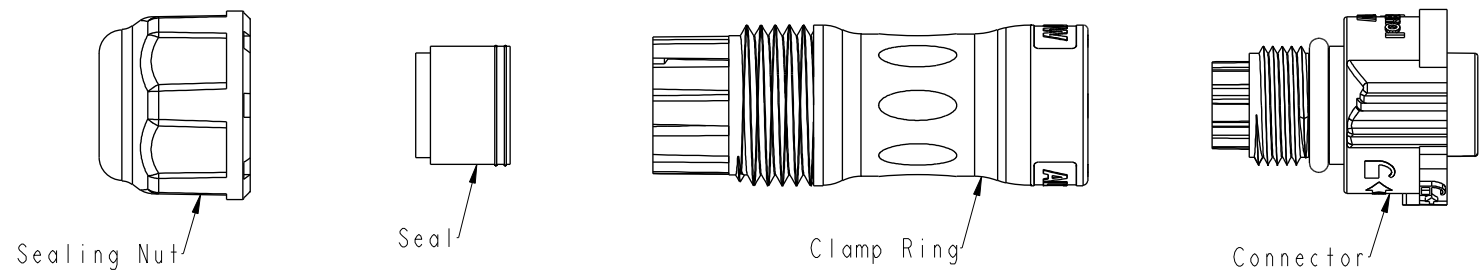

- BD-XXBFFA-QL8XP0
- 02-2Pin
 - 03-3Pin
 - 04-4Pin
 - 05-5Pin
 - 06-6Pin
 - 07-7Pin
 - 08-8Pin

- S: With Red Color Seal 1, Cable OD 5.0~6.0mm.
- M: With Yellow Color Seal 2, Cable OD 6.0~8.0mm.
- L: With Blue Color Seal 3, Cable OD 8.0~10.0mm.
- A: With Seal 1 & Seal 2 & Seal 3.

- △C Note:
- * ∅ Important Dimension
 - * Waterproof Rate: IP68, Mated
 - IP68: 1M Depth Of Water In 24hours
 - * Housing: Thermoplastic, Black
 - * Pin: Copper Alloy, Gold Plated
 - * Clamp Ring: Thermoplastic, Black
 - * Sealing Nut: Thermoplastic, Black
 - * Seals: Rubber

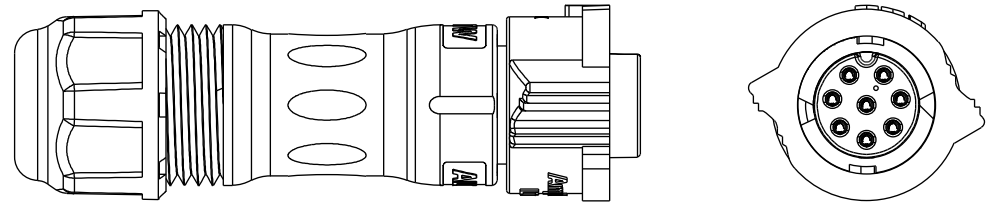

Pin Assignments Front View

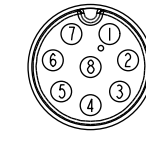
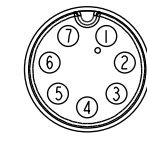
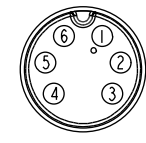
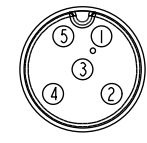
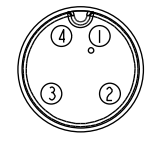
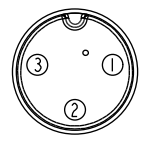
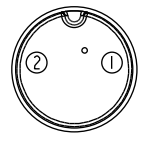

2 Pin

3 Pin

4 Pin

5 Pin

6 Pin

7 Pin

8 Pin

UNIT:mm		TITLE XLOK, B-5A, CABLE W/O SR F, F, FI CRIMP, XLOK	
TOLERANCE	$\pm 0.5\text{mm}$	SCALE 1:1	SIZE A4
		REV. C	WC-REV. A.5
			SHEET 1 OF 1
			QC: Inspection item

Amphenol LTW
安費諾亮泰企業股份有限公司

ITEM NO	DRAWN BY Jane	DATE 2019-07-26
DWG NO BD-XXBFFA-QL8XP0	CHECKED BY Brady	DATE 2019-07-26
CUSTOMER ALTW	APPROVED BY Neo	DATE 2019-07-26