

REV. B	EON NO. E3-710066	DATE 2006/12/15	SIGN DongYali	DESCRIPTION Move 0-Ring To ZSE00100620
--------	-------------------	-----------------	---------------	--

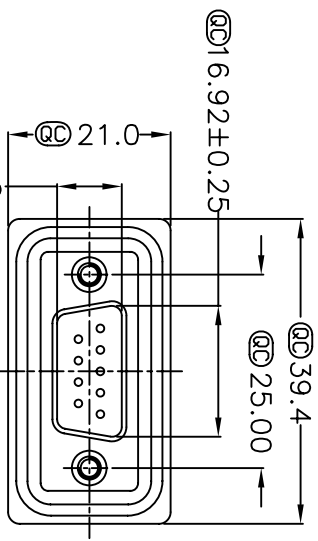

Note:

- * @C Important Dimension.
- * Waterproof Rate : IP68
- * IP68: 1M of depth of water 24 hours (防水等級 IP68)
- * (IP68: 1米水深 24小時)
- * Do Mating Test After Glued 點膠後, 須作對插測試
- * D-SUB Conn. : Black Core , PBT
- * Plastic Jacket : Black , Nylon+GF
- * Pin : Copper Alloy , Gold Plated
- * Ring : Light Blue,Silicone
- * Screw : Copper Alloy,Nickel Plated,#4-40 UNC

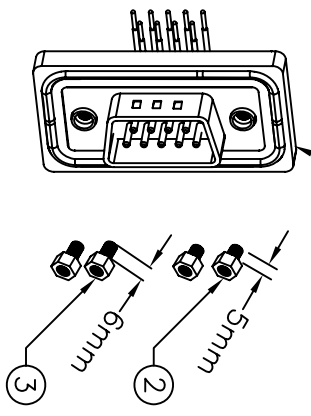
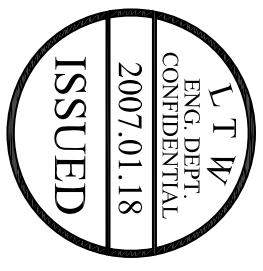
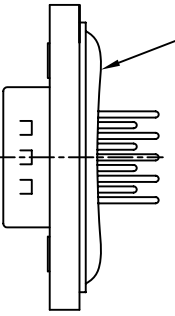
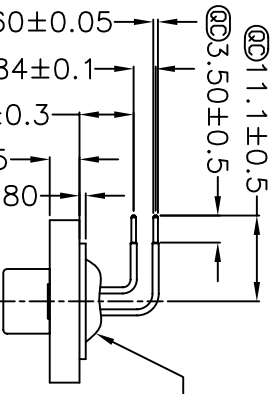
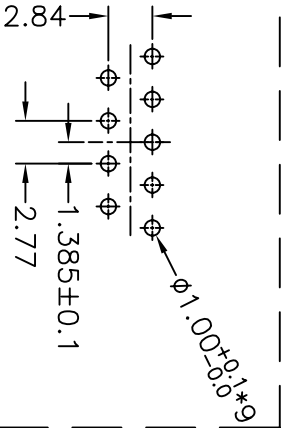

9 Pin Female Connector
PCB Pin Layout
Scale 2:1

Panel Thickness
面板厚度
X(Max.)

Screw L=5.0 For Panel Thickness
Under 1.2mm
適用板厚為 1.2mm 以下

Screw L=6.0 For Panel Thickness
Between 1.2~2.0mm
適用板厚為 1.2~2.0mm

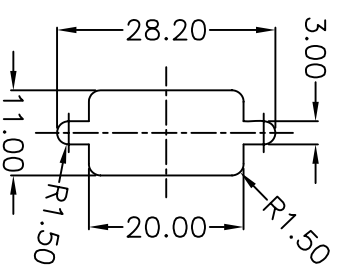

Recommended Panel Cut-Out
建議挖孔尺寸

UNIT:mm	TITLE D-SUB Conn. DB9P M Conn. M Pin	ITEM NO LTWSDB-09PMP-SR8001	DRAWN BY DongYali	DATE 2006/12/15
TOLERANCE .X .XX XXX ANGLES	SCALE Free	DWG NO LTWSDB-09PMP-SR8001	CHECKED BY Simon	DATE 2006/12/15
±0.25 ±0.1 ±0.05 ±1°	REV. B	CUSTOMER	APPROVED BY Max	DATE 2006/12/15
	SHEET 1 OF 1			
	:@: Inspection Item			
		亮泰企業股份有限公司		